



Safety Identification

A visual way of communicating safety information, which minimises the risk of an accident.

About BRADY



Once you have worked with BRADY, our name will stick with you, (just like our labels) because BRADY is one of the world's leading labelling and identification specialists.

Innovative

At BRADY we continue to improve. We have many customers from all industries, and we strive to be ahead of their needs by continuing to invest in research for even more performant solutions. By developing more user-friendly and efficient concepts, we give our thousands of customers the best in the market.

Strength

At BRADY, we believe our biggest strength is the wide range of identification and safety solutions we can offer our customers, whether it's labelling the smallest component or complete signage for an entire warehouse. We're also proud to offer many products and services - from printers, scanners and software to service contracts and on-site training - that compliment any identification job. And don't forget, our wide network of expert distributors can always offer you a tailor-made solution to meet your specific requirements.

Trust

For over a hundred years, BRADY has been connected with quality, trust and stability. We demand the best for your products and services, because we know, better than anyone, the importance of good and reliable identification. Identification looks like a small detail, but every professional knows that this kind of detail is crucial to any business.

Inform

We also have specialised dealers in your region, who can answer all your identification, safety and labelling questions, specific to your activity. They will be happy to provide you with all kinds of options and solutions with no obligation.

Microsoft is a trademark of Microsoft Corporation, Bluetooth is a trademark of Bluetooth Sig, Inc., Android is a trademark of Google Inc.



Brady products are sold on the condition that the purchaser will test them in actual use and determine for himself/herself their suitability to his/her intended purpose. Brady warrants to the purchaser that Brady products are free from defects in material and workmanship but limits its obligation under this warranty to the replacement of the product which has been shown to Brady's satisfaction to have been defective at the time of its purchase.

The warranty does not extend to any persons who have acquired the product from the purchaser. It is in lieu of any other warranty, including every warranty of sale-ability, marketability or suitability for the intended purpose, and is also in lieu of any other obligation or liability on the part of Brady.

Under no circumstances will Brady be liable for losses, damage, costs or subsequent damage of whatever nature which may arise in connection with the use of, or inability to use, Brady's products.

Safety Identification

TABLE OF CONTENTS

Materials.....	4-5
Go For Zero.....	6
Occupational Safety Signs	
Signage: what do you need to know?	8
Evacuation & First Aid	10
Fire safety	52
Danger.....	70
Prohibition.....	110
Mandatory.....	154
Customised signs	196
Safety Sign Sliders.....	198
Maritime Signage	
NiteGlo™ and Xtra Glo™ glow-in-the-dark signs	202
Evacuation & First aid	203
Fire safety	207
Mandatory.....	216
Hazardous Product Signage	
Do all of your chemical products carry labels?	218
SDS components and label format	219
CLP/GHS pictograms and hazard classes	220
Labels with CLP/GHS symbols.....	221
CLP/GHS labels for Brady printers	222
Transport signage.....	223
Other signage & accessories	
Public information.....	226
Symbol labels.....	228
Packaging labels	229
Temperature indicating labels.....	231
Other signage and accessories	233
Printer Solutions	
BBP™85 Sign and Label Printer	236
BradyJet J5000 Colour Label Printer	237
BBP™35 Multicolour Sign & Label Printer	238
BBP™37 Multicolour & Cut Sign & Label Printer	238
Brady Workstation.....	238
BBP™30 and BBP™31 Sign and Label Printer.....	239
BMP™71 Label Printer	239
Index	
Index by part number.....	240
Index by description.....	250

The Brady Advantage

When it comes to identification, safety and compliance, there's a clear advantage to working with Brady. We put our customers first in everything we do.

Our goal is to give you an unrivalled customer experience. We are relentlessly committed to performance and excellence - in our products, services and people.

Our products and solutions perform in ways that others simply can't match. Our people perform in ways that regularly exceed your expectations. And our focus and discipline work toward solid, long-term performance for our customers.

In short, Brady is the company you trust when performance matters most.

Learn more about the Brady Advantage at:
www.bradyeurope.com





See the technical datasheet at www.bradyeurope.com/tds

LAMINATED POLYESTER (B-7541)

Flexible self-adhesive material, printed on white polyester and protected by clear polyester lamination. The permanent, acrylic-based, pressure-sensitive adhesive provides excellent adhesion to surfaces with low surface energy, such as polypropylene and ABS, as well as most powder coatings.

Advantages

- Easily placed on various interior and exterior surfaces
- Multiple applications due to its UV and scratch-resistant laminated surface that withstands numerous chemical products, solvents and extreme temperatures
- Fast, easy application
- Recommended for small formats

Variations

- Numerous standard formats, customisation available
- Available by unit, by sheet or on rolls, for larger amounts
- Standard or photoluminescent (class B and class C, materials B-7568 and B-7582)
- Available with grit-coating for floor marking (material B-7538)



See the technical datasheet at www.bradyeurope.com/tds

POLYPROPYLENE (B-7527)

Rigid, non-adhesive material with protective film (polyester lamination)

Advantages

- Can be fixed to any surface using screws, nails or double-sided adhesive tape
- Multiple applications due to its UV and scratch-resistant laminated surface that withstands numerous chemical products, solvents and extreme temperatures
- Ideal for uneven surfaces or as a signboard

Variations

- Numerous standard formats, customisation available
- Available as standard or photoluminescent (class B and class C, materials B-7568 and B-7582)
- Non-laminated versions available for rounded corners and perforations
- Available as adhesive version (B-7583)

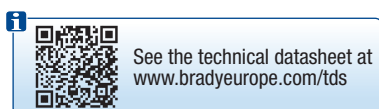

See the technical datasheet at www.bradyeurope.com/tds

ALUMINIUM (B-7525)

Rigid and durable, non-adhesive material with polyester laminate.

Advantages

- Excellent weather resistance
- Can be fixed to any surface using screws or double-sided adhesive tape

Variations

- Customisation possible
- Available in standard and photoluminescent (class C, material B-7590) versions
- Non-laminated versions available on request for rounded corners and perforations

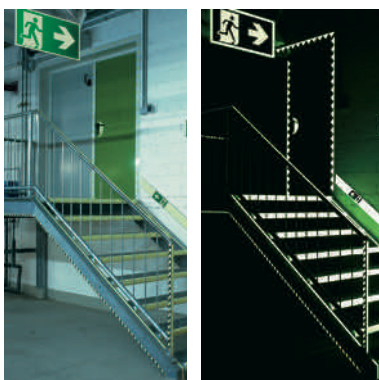

PHOTOLUMINESCENT MATERIALS

Photoluminescent materials are divided into classes, depending on their brightness after 10 minutes (time to evacuate) and 60 minutes (e.g. firemen or electricians working) in the dark. Please note that many countries have set guidelines or norms regulating minimal luminance for photoluminescent safety signage.

NITE-GLO XTRA-GLO

- Nite Glo indicates a class B glow-in-the-dark product, under the DIN 65710 standard
- Xtra Glo indicates a class C glow-in-the-dark product, under the DIN 65710 standard, which means these products will be visible for longer than a class B product with the same initial charge.
- Currently, as a minimum, class B quality is required for marine standards to demand a less significant investment. Class C remains, however, the solution that allows for additional security.



POLYVINYLCHLORIDE (PVC, B-455)

Plastic used for bi-directional signboards, non-adhesive

Advantages

- Allows a signboard to be visible from several directions and from further away
- Fastened using screws or double-sided adhesive tape
- Recommended for overhead applications (above 1.80 m)

Variations

- Numerous formats, customisation available
- Panoramic (3D) and flag (2D) shapes



MAGNETIC (B-859)

For application on metal objects such as machinery.

- Magnetic marking can be used to avoid other types of fastenings (adhesive, screws, etc.).
- It can also be used for temporary signage (out of order), short-term signage (production in progress, production stopped) or mobile signage (product part number to be recommended for stock)
- Magnetic material is also used extensively as part of continuous improvement (Lean, 5S, etc.)



OTHER MATERIALS

On request.

- Fibreglass: To withstand extreme conditions for more than 15 years.
- Window sticker: To stick on the inside of a window or transparent material visible from the outside (e.g. shop door)
- Foam-backed materials: For a rigid surface without restriction of its weight (e.g. construction site safety instructions)
- ToughWash (B-862 / B-863)

Brady Material No.	Material	Temp (°C) (Tested for 30 days)		Max Size	Minimum Size	Thickness (mm)
		Min.	Max.			
B-7541	Laminated Polyester	-40 °C	110 °C	1250 x 1000	100 x 100	0.10 mm
B-7538	Anti-skid Laminated Polyester			1250 x 1000	100 x 100	0.25 mm
B-7527	Polypropylene	-40 °C	120 °C	1100 x 700	60 x 40	1.50 mm
B-7525	Aluminium	-40 °C	140 °C	700 x 700	100 x 100	1.02 mm
B-455	Polyvinylchloride	-20 °C	70 °C	1100 x 700	40 x 30	1.59 mm
B-859	Magnetic Plastic			960 x 560	60 x 40	-
B-7568	Class B Photoluminescent Polyester	-40 °C	66 °C	1250 x 750	100 x 100	0.28 mm
B-7582	Class C Photoluminescent Polyester	-40 °C	66 °C	1250 x 750	100 x 100	0.28 mm
B-7570	Class B Photoluminescent Polypropylene	-40 °C	66 °C	1250 x 750	100 x 100	1.78 mm
B-7584	Class C Photoluminescent Polypropylene	-40 °C	66 °C	1250 x 750	100 x 100	1.78 mm
B-7583	Class C Photoluminescent Self-adhesive Polypropylene	-40 °C	66 °C	1250 x 750	100 x 100	1.80 mm
B-7586	Vinyl		60 °C	1400 x 900	200 x 200	0.06 mm
B-7588	Class C Photoluminescent Polyvinylchloride	-40 °C	66 °C	1400 x 900	200 x 200	1.78 mm
B-7590	Aluminium overlaminated with Polyester	-40 °C	66 °C	1250 x 750	100 x 100	1.27 mm

ILLUSTRATIONS TO VIEW SOME OF THE PRODUCT PROPERTIES:

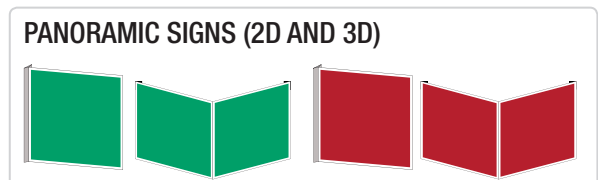
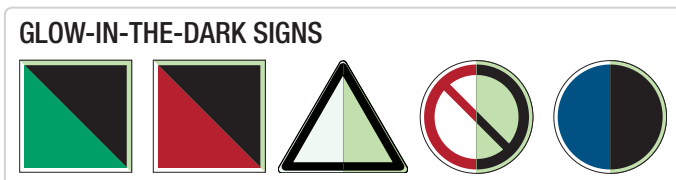
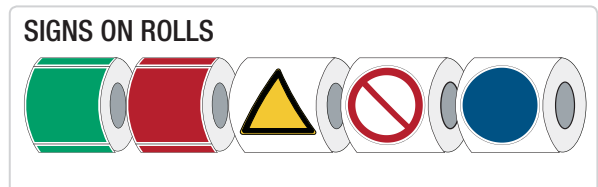



“A co-worker dies, and 160 others have a work-related accident, every 15 seconds. (International Labour Organisation, 2015)
 Workplaces claim more than 2.3 million deaths per year, including 350,000 fatal accidents and close to 2 million life ending work-related diseases.
 In addition, 313 million accidents happen on the job every year, 268 million of those resulting in at least 3 days absence from work. ILO estimates the cost of work accidents & professional diseases indemnities and absences to 4% of the world GDP.
 Workplace accidents not only impact companies (Figure 1) but also people’s lives and the overall health of the available workforce. (Figure 2)

Figure 1: Economic effects of safety and health at company level

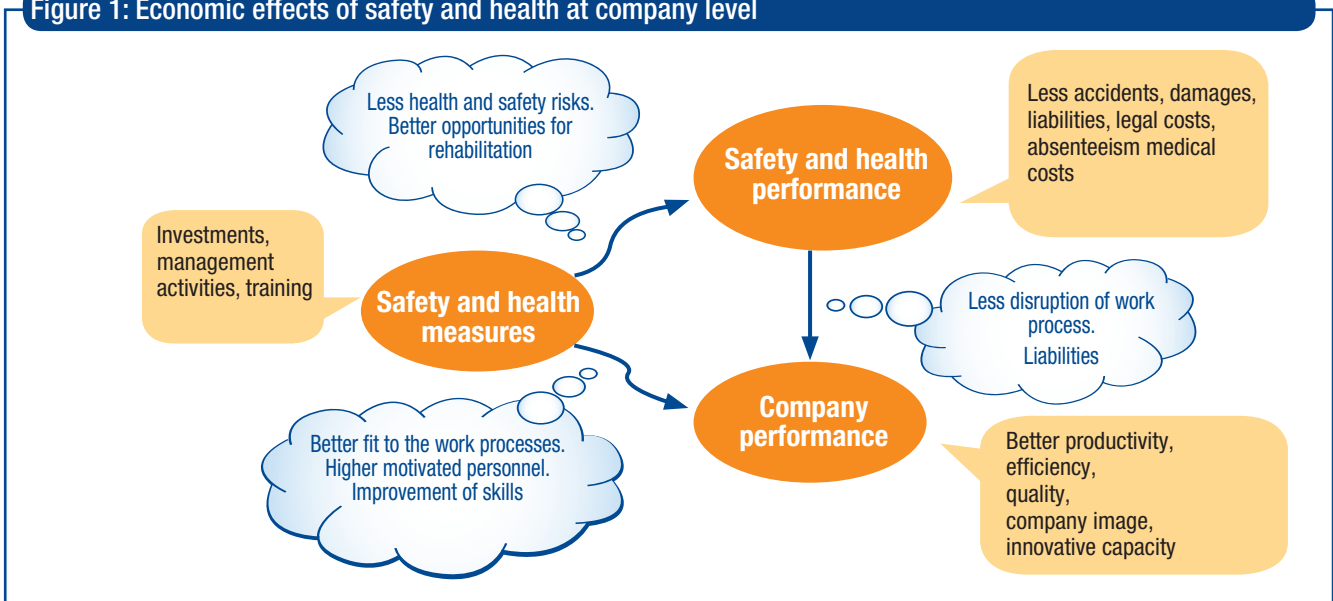
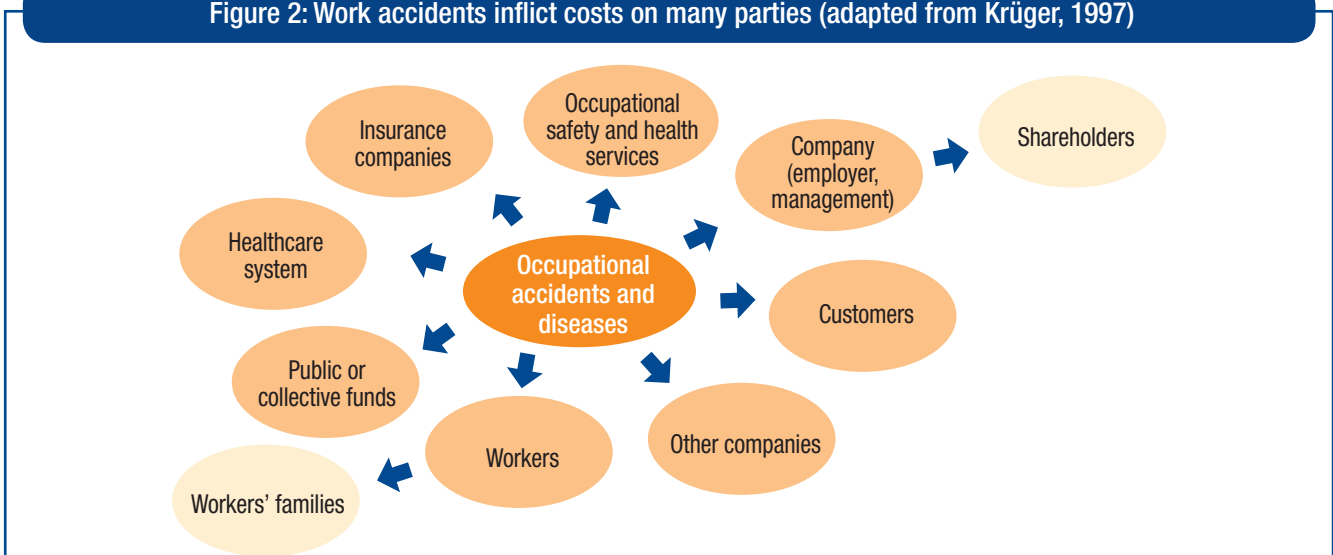

Figure 2: Work accidents inflict costs on many parties (adapted from Krüger, 1997)



Source: Inventory of socioeconomic costs of work accidents, Joss Mossnik, Marc de Greef, 2002

Throughout the world, companies are starting to meet the workplace safety challenge with intensive ‘Go for Zero’-strategies, expressing their unwavering ambition to reduce workplace accidents. Brady, a worldwide manufacturer and supplier of Safety Solutions, supports ‘Go for Zero’-strategies with a broad range of quality products, including on-site printable safety signage, custom signs, pipe markers, spill control and Lockout/Tagout.

In this brochure, you can look through our solutions for maintenance related accident prevention. Solutions related to other activities can be found in our other safety solutions brochures.



Occupational Safety Signs

Signage: what do you need to know?.....	8
Evacuation & First Aid	10
Fire safety.....	52
Danger	70
Prohibition	110
Mandatory	154
Customised signs	196
Safety Sign Sliders.....	198

Signage: what do you need to know?

Safety Signs EN ISO 7010, GHS/CLP

The list of pictograms is not exhaustive, visit www.bradyeurope.com to find all available pictograms

BRADY
WHEN PERFORMANCE MATTERS MOST™

ISO 7010 was first introduced in 2003, then updated in 2012. It was adopted within the European Union to provide a standardised and easily-understood safety message, wherever you are and whatever language is used.

Why EN ISO 7010?

The purpose of the standard is to introduce a globally recognised range of safety pictograms. Although many will already be familiar, some are new introductions. While any new compliance regulations are unlikely to demand immediate change, it is always best practise to keep your safety signage aligned with the new, compliant symbols to avoid confusion.

Where does EN ISO 7010 apply?

This standard regulates safety signage in workplaces and other sites requiring people to be informed about safety matters, whether emergency exits or hazardous areas.

What does Brady offer?

Brady always offers the latest safety signage to guarantee your compliance to regulation. EN ISO 7010 safety signs are available in different materials to meet the restrictions of various industrial environments.

Order Ref.	Width (mm)	Height (mm)	Layout	Total Qty/Pack
197348	400	585	Portrait	1 Piece(s) / Piece

	Prohibition	Fire-fighting equipment
	Caution! Hazard risk	
		Emergency Evacuation & First Aid
	Obligation	Indication or instruction

Safety colours and shapes

Colour and geometric coding are extremely important regarding signage and safety. For example, colours warn of an immediate danger to trigger the reflex to avoid it.

Combining a colour and a shape conveys a message.

The red circle necessarily means a prohibition, the yellow triangle a hazard, a green square an emergency route or a first aid instrument.

The red square indicates a fire-fighting tool.

Blue, for a circular sign, identifies an obligation. If square, it will simply be an indication.

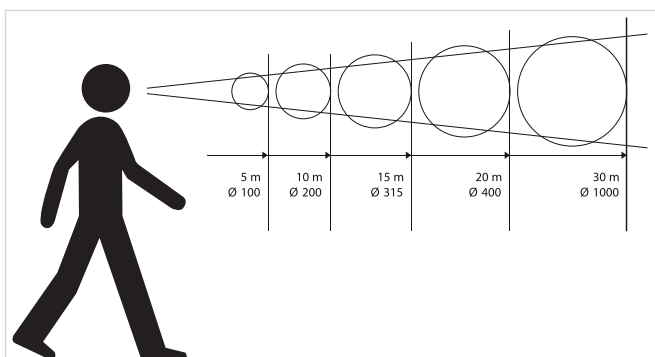

Reading distance

Sign sizes depend on reading distance. The diagram opposite allows you to ensure that dimensions of a pictogram meet European Directives as closely as possible.

Photoluminescent signs must be used where natural lighting is inadequate (especially to mark exits and emergency exits).

CUSTOMISED SIGNS

You can order a custom safety sign showing a pictogram from the EN ISO 7010 range with the text of your choice. At the end of this brochure you will find a couple of pages with ordering information for these custom safety signs.

As well as the EN ISO 7010 signs, Brady will continue offering safety signs with text and pictograms in accordance with The Health & Safety (Safety Signs & Signals) Regulations.

Visit www.bradyeurope.com for the full range.

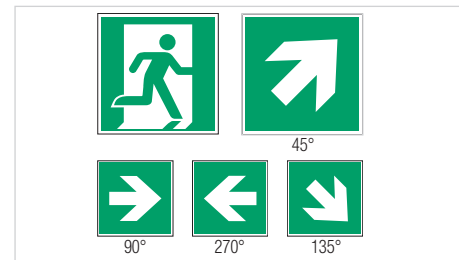

ARROWS

Arrows must always be used alongside emergency exit pictograms.

INSTALLATION GUIDE

Two types of situations and linked instructions are to be differentiated: daily work life, and emergency and fire situations.

In daily work life danger warnings will routinely be placed close to hazards. Prohibitions and requirements will generally be at an area or a workplace entrance. They can be repeated around machinery.

In case of fire or emergency, the symbols indicating control instruments such as escape routes or emergency tools must be highly visible, from near and far. In such case three levels are to be considered:

- The high level (above 1.80 m) is to be seen from far away or when there is an obstruction (stampede).
- The low level (less than 0.4 m from the floor or on the floor) is to be visible in case of fire or smoke.
- The intermediate level is to be visible from nearby and allows instructions or diagrams to be read.

For easy evacuation, it is essential to point out any obstacle, step, ramp etc. Glow-in-the-dark material is therefore the preferred material.

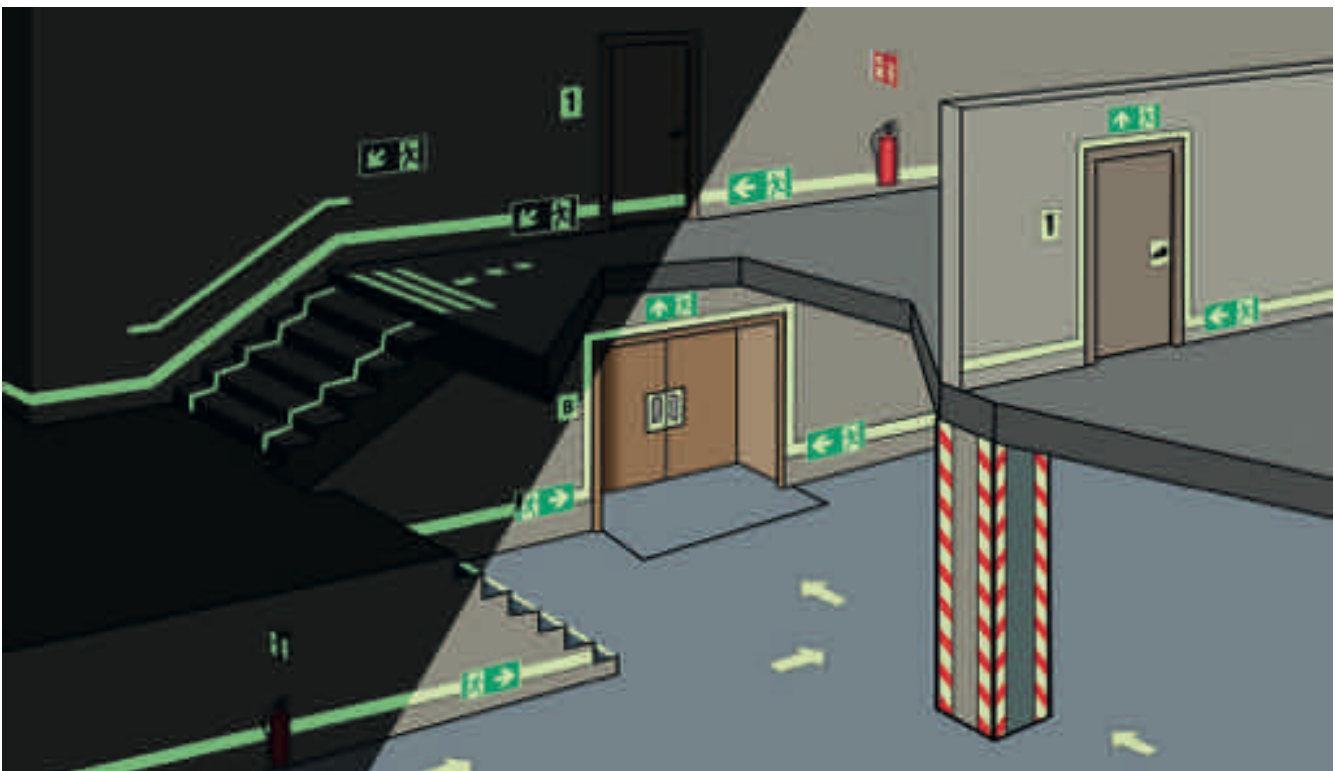

Evacuation & First Aid

Symbol	Legend	Page
	E001 : Emergency exit (left)	11
	A0/E001 : Emergency exit (left)	12
	A180/E001 : Emergency exit (left)	12
	A225/E001 : Emergency exit (left)	13
	A270/E001 : Emergency exit (left)	13
	A315/E001 : Emergency exit (left)	14
	E002 : Emergency exit (right)	15
	E002/A0 : Emergency exit (right)	16
	E002/A45 : Emergency exit (right)	17
	E002/A90 : Emergency exit (right)	17
	E002/A135 : Emergency exit (right)	18
	E002/A180 : Emergency exit (right)	18
	A045 : Direction arrow 45°, top right corner	19
	A090 : Direction arrow 90°, to the right	20
	A135 : Direction arrow 135°, down right corner	21
	A270 : Direction arrow 270°, to the left	21
	E003 : First aid	22
	E004 : Emergency telephone	23
	E007 : Evacuation assembly point	24
	E008 : Break to obtain access	25
	E009 : Doctor	26
	E010 : Automated external heart defibrillator	27
	E011 : Eyewash station	28
	E012 : Safety shower	29
	E013 : Stretcher	30
	E014 : Child seat presence and orientation detection system (CPOD)	31
	E015 : Drinking water	32
	E016 : Emergency window with escape ladder (left)	33
	E016B : Emergency window with escape ladder (right)	34

Symbol	Legend	Page
	E016C : Emergency window	34
	E017 : Rescue window	34
	E018 : Turn anticlockwise to open	35
	E019 : Turn clockwise to open	36
	E020 : Emergency stop button	37
	E021 : Protection shelter	37
	E022 : Door opens by pushing on the left-hand side	38
	E023 : Door opens by pushing on the right-hand side	38
	E024 : Evacuation temporary refuge	39
	E025 : Emergency hammer	39
	E027 : Medical grab bag	40
	E028 : Oxygen resuscitator	40
	E029 : Emergency escape breathing device	41
	E031 : Shipboard general alarm	41
	E032 : Shipboard assembly station	41
	E033 : Door slides right to open	42
	E034 : Door slides left to open	42
	E035 : Liferaft knife	42
	E036 : Lifeboat	42
	E037 : Rescue boat	43
	E038 : Liferaft	43
	E039 : Davit-launched liferaft	43
	E040 : Lifebuoy	43
	E041 : Lifebuoy with line	44
	E042 : Lifebuoy with light	44

Symbol	Legend	Page
	E043 : Lifebuoy with line and light	44
	E044 : Lifejacket	44
	E045 : Child's lifejacket	45
	E046 : Infant's lifejacket	45
	E047 : Search and rescue transponder	45
	E048 : Survival craft distress signal	45
	E049 : Rocket parachute flare	46
	E050 : Line-throwing appliance	46
	E051 : Two-way VHF radiotelephone apparatus	46
	E052 : Emergency position indicating radio beacon	46
	E053 : Embarkation ladder	47
	E054 : Marine evacuation slide	47
	E055 : Marine evacuation chute	47
	E056 : Survival clothing	47
	E057 : Door opens by pulling on the left-hand side	48
	E058 : Door opens by pulling on the right-hand side	48
	E059 : Escape ladder	49
	E060 : Evacuation chair	49
	PIC 373: Levels (-2 to +9)	50

Complies with EN ISO 7010

E001 : EMERGENCY EXIT (LEFT)

Basic symbol indicating an emergency evacuation. This symbol must be placed in numerous places to ensure that it is seen quickly in the event of an evacuation. Placing it at height will enable better visibility from a distance or in the event of a crowd rush. Placing it near the floor is useful when smoke is present. This symbol generally goes with an arrow for the instructions and the direction to take to be easier to understand.



SIGNS

Order Ref.	Width (mm)	Height (mm)	Total Qty/ Pack
Laminated Polyester			
814263	100	100	1 / Pack
814264	148	148	1 / Pack
814265	200	200	1 / Pack
814266	250	250	1 / Pack
814268	315	315	1 / Pack
814269	400	400	1 / Pack
Polypropylene			
814272	148	148	1 / Pack
814273	200	200	1 / Pack
814274	250	250	1 / Pack
814276	315	315	1 / Pack
814277	400	400	1 / Pack
Aluminium			
814278	100	100	1 / Pack
814279	200	200	1 / Pack

FLOOR MARKING

Order Ref.	Width (mm)	Height (mm)	Total Qty/ Pack
Anti-skid Laminated Polyester			
814270	500	500	1 / Pack

MINI-PICTOGRAMS

Order Ref.	Width (mm)	Height (mm)	Total Qty/ Pack
Vinyl			
814261	10	10	96 / Pack



PHOTOLUMINESCENT SIGNS

Order Ref.	Width (mm)	Height (mm)	Class	Total Qty/ Pack
Class B Photoluminescent Polyester				
834393	150	150	Class B	1 / Pack
836446	200	200	Class B	1 / Pack
Class C Photoluminescent Polyester				
834394	150	150	Class C	1 / Pack
834395	200	200	Class C	1 / Pack
Class B Photoluminescent Polypropylene				
834379	150	150	Class B	1 / Pack
836444	200	200	Class B	1 / Pack
836445	300	300	Class B	1 / Pack
Class C Photoluminescent Polypropylene				
834390	150	150	Class C	1 / Pack
Class C Photoluminescent Self-adhesive Polypropylene				
836447	150	150	Class C	1 / Pack
836448	200	200	Class C	1 / Pack
Class C Photoluminescent Aluminium				
834377	150	150	Class C	1 / Pack
834378	200	200	Class C	1 / Pack



PICTOGRAMS ON ROLLS

Order Ref.	Width (mm)	Height (mm)	Total Qty/ Pack
Laminated Polyester			
814262	100	100	250 / Roll

BRADY
Customise-it

See page 196 to order your custom-made signs.

i For all material properties and applications, see pages 4-5

BI-DIRECTIONAL SIGNS



Order Ref.	Width (mm)	Height (mm)	Layout	Total Qty/ Pack
Polyvinylchloride				
814284	151	151	Bi-directional	1 / Pack
814285	203	203	Bi-directional	1 / Pack
814286	253	253	Bi-directional	1 / Pack
814287	318	318	Bi-directional	1 / Pack

SIGNS WITH TEXT



Order Ref.	Width (mm)	Height (mm)	Layout	Legend	Total Qty/ Pack
Laminated Polyester					
814339	150	50	Landscape	Emergency exit	1 / Pack
814340	297	74	Landscape	Emergency exit	1 / Pack
814341	297	105	Landscape	Emergency exit	1 / Pack
814342	450	150	Landscape	Emergency exit	1 / Pack
814343	600	200	Landscape	Emergency exit	1 / Pack
814336	148	210	Portrait	Emergency exit	1 / Pack
814337	210	297	Portrait	Emergency exit	1 / Pack
814338	297	420	Portrait	Emergency exit	1 / Pack
Polypropylene					
814347	150	50	Landscape	Emergency exit	1 / Pack
814348	297	74	Landscape	Emergency exit	1 / Pack
814349	297	105	Landscape	Emergency exit	1 / Pack
814350	450	150	Landscape	Emergency exit	1 / Pack
814351	600	200	Landscape	Emergency exit	1 / Pack
814344	148	210	Portrait	Emergency exit	1 / Pack
814345	210	297	Portrait	Emergency exit	1 / Pack
814346	297	420	Portrait	Emergency exit	1 / Pack
Aluminium					
814355	150	50	Landscape	Emergency exit	1 / Pack
814356	297	105	Landscape	Emergency exit	1 / Pack
814357	450	150	Landscape	Emergency exit	1 / Pack
814352	148	210	Portrait	Emergency exit	1 / Pack
814353	210	297	Portrait	Emergency exit	1 / Pack
814354	297	420	Portrait	Emergency exit	1 / Pack

PHOTOLUMINESCENT SIGNS WITH TEXT



Order Ref.	Width (mm)	Height (mm)	Class	Legend	Total Qty/ Pack
Class B Photoluminescent Polyester					
836829	300	150	Class B	Exit	1 / Pack
834362	300	150	Class B	Emergency exit only	1 / Pack
834373	300	150	Class B	Fire exit	1 / Pack
834364	450	150	Class B	Emergency exit only	1 / Pack
834367	450	150	Class B	Exit for emergency use only	1 / Pack
836830	450	150	Class B	Exit	1 / Pack
834375	600	300	Class B	Fire exit	1 / Pack
Class C Photoluminescent Polyester					
834376	600	300	Class C	Fire exit	1 / Pack
Class B Photoluminescent Polypropylene					
836827	300	150	Class B	Exit	1 / Pack
834356	300	150	Class B	Emergency exit only	1 / Pack
834369	300	150	Class B	Fire exit	1 / Pack
834359	450	150	Class B	Emergency exit only	1 / Pack
834365	450	150	Class B	Exit for emergency use only	1 / Pack
836828	450	150	Class B	Exit	1 / Pack
834370	600	300	Class B	Fire exit	1 / Pack
Class C Photoluminescent Polypropylene					
834371	300	150	Class C	Fire exit	1 / Pack
834372	600	300	Class C	Fire exit	1 / Pack



AO/E001 : EMERGENCY EXIT (LEFT)

Emergency exits must be clearly indicated in all buildings.

To avoid any confusion, the upward-pointing arrow should always be used to indicate the “go straight ahead direction”, the downwards-pointing arrow only where there is a down staircase.



SIGNS

Order Ref.	Width (mm)	Height (mm)	Total Qty/ Pack
Laminated Polyester			
198482	210	105	1 / Pack
198483	297	148	1 / Pack
139137	400	200	1 / Pack
Polypropylene			
138865	210	105	1 / Pack
138922	297	148	1 / Pack
139138	400	200	1 / Pack
Aluminium			
198484	297	148	1 / Pack



PHOTOLUMINESCENT SIGNS

Order Ref.	Width (mm)	Height (mm)	Class	Total Qty/ Pack
Class C Photoluminescent Polyester				
836362	300	150	Class C	1 / Pack
836363	400	200	Class C	1 / Pack
Class C Photoluminescent Self-adhesive Polypropylene				
836364	300	150	Class C	1 / Pack
836365	400	200	Class C	1 / Pack
Class C Photoluminescent Aluminium				
836360	300	150	Class C	1 / Pack
836361	400	200	Class C	1 / Pack

i For a non-adhesive or class B version, see pictogram E002/A0 on page 16



A180/E001 : EMERGENCY EXIT (LEFT)

The downwards pointing arrow is to be used only where there are stairs in order to avoid any possible confusion. To indicate that people should proceed in a specific direction, the “upwards-pointing arrow (AO) is to be favoured.



SIGNS

Order Ref.	Width (mm)	Height (mm)	Total Qty/ Pack
Laminated Polyester			
139132	210	105	1 / Pack
139133	297	148	1 / Pack
138863	400	200	1 / Pack
Polypropylene			
138864	210	105	1 / Pack
138919	297	148	1 / Pack
138918	400	200	1 / Pack
Aluminium			
138941	297	148	1 / Pack



PHOTOLUMINESCENT SIGNS

Order Ref.	Width (mm)	Height (mm)	Class	Total Qty/ Pack
Class C Photoluminescent Polyester				
139212	300	150	Class C	1 / Pack
139214	400	200	Class C	1 / Pack
Class C Photoluminescent Self-adhesive Polypropylene				
836375	300	150	Class C	1 / Pack
836376	400	200	Class C	1 / Pack
Class C Photoluminescent Aluminium				
139213	300	150	Class C	1 / Pack
836372	400	200	Class C	1 / Pack

i For all material properties and applications, see pages 4-5

Complies with EN ISO 7010

A225/E001 : EMERGENCY EXIT (LEFT)

The downwards pointing arrow is to be used only where there are stairs in order to avoid any possible confusion. To indicate that people should proceed in a diagonal direction, the "top left-hand corner arrow (A335) is to be favoured.



SIGNS

Order Ref.	Width (mm)	Height (mm)	Total Qty/ Pack
Laminated Polyester			
138883	210	105	1 / Pack
138884	297	148	1 / Pack
138868	400	200	1 / Pack
Polypropylene			
138869	210	105	1 / Pack
138923	297	148	1 / Pack
138924	400	200	1 / Pack
Aluminium			
138944	400	200	1 / Pack



PHOTOLUMINESCENT SIGNS

Order Ref.	Width (mm)	Height (mm)	Class	Total Qty/ Pack
Class B Photoluminescent Polyester				
836386	150	75	Class B	1 / Pack
834204	300	150	Class B	1 / Pack
834206	600	300	Class B	1 / Pack
Class C Photoluminescent Polyester				
836388	300	150	Class C	1 / Pack
836389	400	200	Class C	1 / Pack
Class B Photoluminescent Polypropylene				
834201	300	150	Class B	1 / Pack
834203	600	300	Class B	1 / Pack
Class C Photoluminescent Self-adhesive Polypropylene				
836390	300	150	Class C	1 / Pack
836391	400	200	Class C	1 / Pack
Class C Photoluminescent Aluminium				
836382	300	150	Class C	1 / Pack
836383	400	200	Class C	1 / Pack



PHOTOLUMINESCENT SIGNS WITH TEXT

Order Ref.	Width (mm)	Height (mm)	Class	Legend	Total Qty/ Pack
Class B Photoluminescent Polyester					
830943	300	150	Class B	Exit	1 / Pack
834197	300	150	Class B	Fire exit	1 / Pack
830944	450	150	Class B	Exit	1 / Pack
834198	450	150	Class B	Fire exit	1 / Pack
Class C Photoluminescent Polyester					
834199	300	150	Class C	Fire exit	1 / Pack
834200	450	150	Class C	Fire exit	1 / Pack
Class B Photoluminescent Polypropylene					
830890	300	150	Class B	Exit	1 / Pack
830945	300	150	Class B	Fire exit	1 / Pack
830928	450	150	Class B	Exit	1 / Pack
830950	450	150	Class B	Fire exit	1 / Pack
Class C Photoluminescent Polypropylene					
834195	300	150	Class C	Fire exit	1 / Pack
834196	450	150	Class C	Fire exit	1 / Pack

BI-DIRECTIONAL PHOTOLUMINESCENT SIGNS



Order Ref.	Width (mm)	Height (mm)	Layout	Class	Total Qty/ Pack
Class B Photoluminescent Polyvinylchloride					
836384	303	151	Bi-directional	Class B	1 / Pack

Complies with EN ISO 7010

A270/E001 : EMERGENCY EXIT (LEFT)

The "left-pointing arrow combined with the symbol of a man running to the left reinforces the directional message to ensure clear understanding in the event of an evacuation.



SIGNS

Order Ref.	Width (mm)	Height (mm)	Total Qty/ Pack
Laminated Polyester			
138879	210	105	1 / Pack
138880	297	148	1 / Pack
138859	400	200	1 / Pack
Polypropylene			
138860	210	105	1 / Pack
138914	297	148	1 / Pack
138913	400	200	1 / Pack
Aluminium			
138937	297	148	1 / Pack
138938	400	200	1 / Pack



PHOTOLUMINESCENT SIGNS

Order Ref.	Width (mm)	Height (mm)	Class	Total Qty/ Pack
Class B Photoluminescent Polyester				
836396	150	75	Class B	1 / Pack
836397	300	150	Class B	1 / Pack
Class C Photoluminescent Polyester				
138948	300	150	Class C	1 / Pack
836399	400	200	Class C	1 / Pack
Class B Photoluminescent Polypropylene				
836395	300	150	Class B	1 / Pack
Class C Photoluminescent Polypropylene				
834253	300	150	Class C	1 / Pack
Class C Photoluminescent Self-adhesive Polypropylene				
836400	300	150	Class C	1 / Pack
836401	400	200	Class C	1 / Pack
Class C Photoluminescent Aluminium				
836393	300	150	Class C	1 / Pack
836394	400	200	Class C	1 / Pack



PHOTOLUMINESCENT SIGNS WITH TEXT

Order Ref.	Width (mm)	Height (mm)	Class	Legend	Total Qty/ Pack
Class B Photoluminescent Polyester					
834209	300	150	Class B	Exit	1 / Pack
834237	300	150	Class B	Fire exit	1 / Pack
834210	450	150	Class B	Exit	1 / Pack
834238	450	150	Class B	Fire exit	1 / Pack
Class C Photoluminescent Polyester					
834239	300	150	Class C	Fire exit	1 / Pack
834240	450	150	Class C	Fire exit	1 / Pack
Class B Photoluminescent Polypropylene					
834207	300	150	Class B	Exit	1 / Pack
834213	300	150	Class B	Fire exit	1 / Pack
834208	450	150	Class B	Exit	1 / Pack
834214	450	150	Class B	Fire exit	1 / Pack
Class C Photoluminescent Polypropylene					
834215	300	150	Class C	Fire exit	1 / Pack
834218	450	150	Class C	Fire exit	1 / Pack
Class C Photoluminescent Aluminium					
834211	300	150	Class C	Fire Exit	1 / Pack
834212	450	150	Class C	Fire exit	1 / Pack



BI-DIRECTIONAL SIGNS

Order Ref.	Width (mm)	Height (mm)	Layout	Total Qty/ Pack
Polyvinylchloride				
139242	403	203	Bi-directional	1 / Pack

i For all material properties and applications, see pages 4-5



A315/E001 : EMERGENCY EXIT (LEFT)

The arrow combined with the evacuation symbol clarifies the direction to follow in case of evacuation.



SIGNS

Order Ref.	Width (mm)	Height (mm)	Total Qty/ Pack
Laminated Polyester			
198485	210	105	1 / Pack
138885	297	148	1 / Pack
198486	400	200	1 / Pack
Polypropylene			
198487	210	105	1 / Pack
138925	297	148	1 / Pack
198488	400	200	1 / Pack
Aluminium			
198489	297	148	1 / Pack



PHOTOLUMINESCENT SIGNS

Order Ref.	Width (mm)	Height (mm)	Class	Total Qty/ Pack
Class B Photoluminescent Polyester				
836422	150	75	Class B	1 / Pack
836423	300	150	Class B	1 / Pack
Class C Photoluminescent Polyester				
134658	300	150	Class C	1 / Pack
134659	400	200	Class C	1 / Pack
Class B Photoluminescent Polypropylene				
834309	300	150	Class B	1 / Pack
836421	300	150	Class B	1 / Pack
834316	600	300	Class B	1 / Pack
Class C Photoluminescent Aluminium				
134656	300	150	Class C	1 / Pack
134657	400	200	Class C	1 / Pack



PHOTOLUMINESCENT SIGNS WITH TEXT

Order Ref.	Width (mm)	Height (mm)	Class	Legend	Total Qty/ Pack
Class B Photoluminescent Polyester					
834266	300	150	Class B	Exit	1 / Pack
834299	300	150	Class B	Fire exit	1 / Pack
834267	450	150	Class B	Exit	1 / Pack
834301	450	150	Class B	Fire exit	1 / Pack
Class C Photoluminescent Polyester					
834305	300	150	Class C	Fire exit	1 / Pack
834308	450	150	Class C	Fire exit	1 / Pack
Class B Photoluminescent Polypropylene					
834263	300	150	Class B	Exit	1 / Pack
834290	300	150	Class B	Fire exit	1 / Pack
834265	450	150	Class B	Exit	1 / Pack
834292	450	150	Class B	Fire exit	1 / Pack
Class C Photoluminescent Polypropylene					
834294	300	150	Class C	Fire exit	1 / Pack
834296	450	150	Class C	Fire exit	1 / Pack

BI-DIRECTIONAL PHOTOLUMINESCENT SIGNS



Order Ref.	Width (mm)	Height (mm)	Layout	Class	Total Qty/ Pack
Class B Photoluminescent Polyvinylchloride					
836428	303	151	Bi-directional	Class B	1 / Pack



Use glow-in-the-dark tape to create a safe path to the emergency exit. Contact your Brady distributor to find out more about our full range of marking and signage products.

i For all material properties and applications, see pages 4-5

Complies with EN ISO 7010

E002 : EMERGENCY EXIT (RIGHT)

Basic symbol indicating an emergency evacuation. This symbol must be placed in numerous places to ensure that it is seen quickly in the event of an evacuation. Placing it at height will enable better visibility from a distance or in the event of a crowd rush. Placing it near the floor is useful when smoke is present.

This symbol generally goes with an arrow for the instructions and the direction to take to be easier to understand.



SIGNS

Order Ref.	Width (mm)	Height (mm)	Total Qty/ Pack
Laminated Polyester			
814436	100	100	1 / Pack
814437	148	148	1 / Pack
814438	200	200	1 / Pack
814439	250	250	1 / Pack
814441	315	315	1 / Pack
814442	400	400	1 / Pack
Polypropylene			
814445	148	148	1 / Pack
814446	200	200	1 / Pack
814447	250	250	1 / Pack
814449	315	315	1 / Pack
814450	400	400	1 / Pack
Aluminium			
814451	100	100	1 / Pack
814452	200	200	1 / Pack

FLOOR MARKING

Order Ref.	Width (mm)	Height (mm)	Total Qty/ Pack
Anti-skid Laminated Polyester			
814443	500	500	1 / Pack

MINI-PICTOGRAMS

Order Ref.	Width (mm)	Height (mm)	Total Qty/ Pack
Vinyl			
814434	10	10	96 / Pack



PHOTOLUMINESCENT SIGNS

Order Ref.	Width (mm)	Height (mm)	Class	Total Qty/ Pack
Class B Photoluminescent Polyester				
834488	150	150	Class B	1 / Pack
836532	200	200	Class B	1 / Pack
Class C Photoluminescent Polyester				
834489	150	150	Class C	1 / Pack
834490	200	200	Class C	1 / Pack
Class B Photoluminescent Polypropylene				
834486	150	150	Class B	1 / Pack
836530	200	200	Class B	1 / Pack
836531	300	300	Class B	1 / Pack
Class C Photoluminescent Self-adhesive Polypropylene				
836533	150	150	Class C	1 / Pack
836534	200	200	Class C	1 / Pack
Class C Photoluminescent Aluminium				
834484	150	150	Class C	1 / Pack
834485	200	200	Class C	1 / Pack



PICTOGRAMS ON ROLLS

Order Ref.	Width (mm)	Height (mm)	Total Qty/ Pack
Laminated Polyester			
814435	100	100	250 / Roll

BI-DIRECTIONAL SIGNS



Order Ref.	Width (mm)	Height (mm)	Layout	Total Qty/ Pack
Polyvinylchloride				
814453	151	151	Bi-directional	1 / Pack
814454	203	203	Bi-directional	1 / Pack
814455	253	253	Bi-directional	1 / Pack
814456	318	318	Bi-directional	1 / Pack

SIGNS WITH TEXT



Order Ref.	Width (mm)	Height (mm)	Layout	Legend	Total Qty/ Pack
Laminated Polyester					
814508	150	50	Landscape	Emergency exit	1 / Pack
814509	297	74	Landscape	Emergency exit	1 / Pack
814510	297	105	Landscape	Emergency exit	1 / Pack
814511	450	150	Landscape	Emergency exit	1 / Pack
814512	600	200	Landscape	Emergency exit	1 / Pack
814505	148	210	Portrait	Emergency exit	1 / Pack
814506	210	297	Portrait	Emergency exit	1 / Pack
814507	297	420	Portrait	Emergency exit	1 / Pack
Polypropylene					
814516	150	50	Landscape	Emergency exit	1 / Pack
814517	297	74	Landscape	Emergency exit	1 / Pack
814518	297	105	Landscape	Emergency exit	1 / Pack
814519	450	150	Landscape	Emergency exit	1 / Pack
814520	600	200	Landscape	Emergency exit	1 / Pack
814513	148	210	Portrait	Emergency exit	1 / Pack
814514	210	297	Portrait	Emergency exit	1 / Pack
814515	297	420	Portrait	Emergency exit	1 / Pack
Aluminium					
814524	150	50	Landscape	Emergency exit	1 / Pack
814525	297	105	Landscape	Emergency exit	1 / Pack
814526	450	150	Landscape	Emergency exit	1 / Pack
814521	148	210	Portrait	Emergency exit	1 / Pack
814522	210	297	Portrait	Emergency exit	1 / Pack
814523	297	420	Portrait	Emergency exit	1 / Pack

PHOTOLUMINESCENT SIGNS WITH TEXT



Order Ref.	Width (mm)	Height (mm)	Class	Legend	Total Qty/ Pack
Class B Photoluminescent Polyester					
834481	150	150	Class B	Exit for emergency use only	1 / Pack
834483	150	150	Class B	Fire exit	1 / Pack
834739	300	150	Class B	Exit	1 / Pack
834747	300	150	Class B	Exit for emergency use only	1 / Pack
834758	300	150	Class B	Fire exit	1 / Pack
834740	450	150	Class B	Exit	1 / Pack
834748	450	150	Class B	Exit for emergency use only	1 / Pack
834759	450	150	Class B	Fire exit	1 / Pack
834760	600	300	Class B	Fire exit	1 / Pack
Class C Photoluminescent Polyester					
834762	300	150	Class C	Fire exit	1 / Pack
834763	600	300	Class C	Fire exit	1 / Pack
Class B Photoluminescent Polypropylene					
834480	150	150	Class B	Exit for emergency use only	1 / Pack
834482	150	150	Class B	Fire exit	1 / Pack
834737	300	150	Class B	Exit	1 / Pack
834744	300	150	Class B	Exit for emergency use only	1 / Pack
834753	300	150	Class B	Fire exit	1 / Pack
834738	450	150	Class B	Exit	1 / Pack
834745	450	150	Class B	Exit for emergency use only	1 / Pack
834754	450	150	Class B	Fire exit	1 / Pack
834755	600	300	Class B	Fire exit	1 / Pack
Class C Photoluminescent Polypropylene					
834756	300	150	Class C	Fire exit	1 / Pack
834757	600	300	Class C	Fire exit	1 / Pack

BRADY Customise-it See page 196 to order your custom-made signs.



E002/A0 : EMERGENCY EXIT (RIGHT)

The evacuation signboard with the upward-pointing arrow indicates to “go straight ahead.”



SIGNS

Order Ref.	Width (mm)	Height (mm)	Total Qty/ Pack
Laminated Polyester			
198490	210	105	1 / Pack
198494	210	105	1 / Pack
198491	297	148	1 / Pack
198492	400	200	1 / Pack
198495	400	200	1 / Pack
Polypropylene			
138858	210	105	1 / Pack
198496	210	105	1 / Pack
138920	297	148	1 / Pack
138921	400	200	1 / Pack
198497	400	200	1 / Pack
Aluminium			
198493	297	148	1 / Pack
198498	297	148	1 / Pack



PHOTOLUMINESCENT SIGNS

Order Ref.	Width (mm)	Height (mm)	Class	Total Qty/ Pack
Class B Photoluminescent Polyester				
836475	150	75	Class B	1 / Pack
834399	300	150	Class B	1 / Pack
834400	600	300	Class B	1 / Pack
Class C Photoluminescent Polyester				
836451	300	150	Class C	1 / Pack
836452	400	200	Class C	1 / Pack
Class B Photoluminescent Polypropylene				
834396	300	150	Class B	1 / Pack
Class C Photoluminescent Polypropylene				
834398	300	150	Class C	1 / Pack
Class C Photoluminescent Self-adhesive Polypropylene				
836453	300	150	Class C	1 / Pack
836454	400	200	Class C	1 / Pack
Class C Photoluminescent Aluminium				
836449	300	150	Class C	1 / Pack
836450	400	200	Class C	1 / Pack



PHOTOLUMINESCENT SIGNS WITH TEXT

Order Ref.	Width (mm)	Height (mm)	Class	Legend	Total Qty/ Pack
Class B Photoluminescent Polyester					
834709	300	150	Class B	Exit	1 / Pack
834772	300	150	Class B	Fire exit	1 / Pack
834711	450	150	Class B	Exit	1 / Pack
834773	450	150	Class B	Fire exit	1 / Pack
Class C Photoluminescent Polyester					
834775	300	150	Class C	Fire exit	1 / Pack
834776	450	150	Class C	Fire exit	1 / Pack
Class B Photoluminescent Polypropylene					
834706	300	150	Class B	Exit	1 / Pack
834767	300	150	Class B	Fire exit	1 / Pack
834707	450	150	Class B	Exit	1 / Pack
834768	450	150	Class B	Fire exit	1 / Pack
Class C Photoluminescent Polypropylene					
834769	300	150	Class C	Fire exit	1 / Pack
834771	450	150	Class C	Fire exit	1 / Pack
Class C Photoluminescent Aluminium					
834764	300	150	Class C	Fire exit	1 / Pack
834765	450	150	Class C	Fire exit	1 / Pack



Use glow-in-the-dark tape to create a safe path to the emergency exit. Contact your Brady distributor to find out more about our full range of marking and signage products.

i For all material properties and applications, see pages 4-5

Complies with EN ISO 7010

E002/A45 : EMERGENCY EXIT (RIGHT)

The evacuation sign with a “top right-hand corner arrow can be used to clarify a direction.

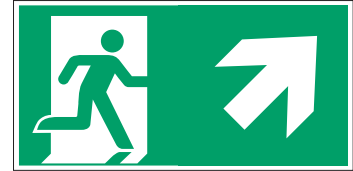

SIGNS

Order Ref.	Width (mm)	Height (mm)	Total Qty/ Pack
Laminated Polyester			
138886	297	148	1 / Pack
Polypropylene			
138926	297	148	1 / Pack



PHOTOLUMINESCENT SIGNS

Order Ref.	Width (mm)	Height (mm)	Class	Total Qty/ Pack
Class B Photoluminescent Polyester				
836498	150	75	Class B	1 / Pack
834444	300	150	Class B	1 / Pack
834445	600	300	Class B	1 / Pack
Class C Photoluminescent Polyester				
138951	300	150	Class C	1 / Pack
Class B Photoluminescent Polypropylene				
834438	300	150	Class B	1 / Pack
834440	600	300	Class B	1 / Pack
Class C Photoluminescent Aluminium				
138963	300	150	Class C	1 / Pack
138964	400	200	Class C	1 / Pack

PHOTOLUMINESCENT SIGNS WITH TEXT



Order Ref.	Width (mm)	Height (mm)	Class	Legend	Total Qty/ Pack
Class B Photoluminescent Polyester					
834725	300	150	Class B	Exit	1 / Pack
834895	300	150	Class B	Fire exit	1 / Pack
834726	450	150	Class B	Exit	1 / Pack
834896	450	150	Class B	Fire exit	1 / Pack
Class C Photoluminescent Polyester					
834897	300	150	Class C	Fire exit	1 / Pack
834898	450	150	Class C	Fire exit	1 / Pack
Class B Photoluminescent Polypropylene					
834723	300	150	Class B	Exit	1 / Pack
834891	300	150	Class B	Fire exit	1 / Pack
834724	450	150	Class B	Exit	1 / Pack
834892	450	150	Class B	Fire exit	1 / Pack
Class C Photoluminescent Polypropylene					
834893	300	150	Class C	Fire exit	1 / Pack
834894	450	150	Class C	Fire exit	1 / Pack

Complies with EN ISO 7010

E002/A90 : EMERGENCY EXIT (RIGHT)

The right pointing arrow combined with the evacuation to the right reinforces the direction to be followed in the event of an evacuation.



SIGNS

Order Ref.	Width (mm)	Height (mm)	Total Qty/ Pack
Laminated Polyester			
138881	210	105	1 / Pack
138882	297	148	1 / Pack
138866	400	200	1 / Pack
Polypropylene			
138867	210	105	1 / Pack
138915	297	148	1 / Pack
139240	400	200	1 / Pack
Aluminium			
138939	297	148	1 / Pack
138940	400	200	1 / Pack



PHOTOLUMINESCENT SIGNS

Order Ref.	Width (mm)	Height (mm)	Class	Total Qty/ Pack
Class B Photoluminescent Polyester				
836507	150	75	Class B	1 / Pack
834451	300	150	Class B	1 / Pack
834452	600	300	Class B	1 / Pack
Class C Photoluminescent Polyester				
836465	300	150	Class C	1 / Pack
836467	400	200	Class C	1 / Pack
Class B Photoluminescent Polypropylene				
834447	300	150	Class B	1 / Pack
834448	600	300	Class B	1 / Pack
Class C Photoluminescent Polypropylene				
834449	300	150	Class C	1 / Pack
Class C Photoluminescent Self-adhesive Polypropylene				
836468	300	150	Class C	1 / Pack
836469	400	200	Class C	1 / Pack
Class C Photoluminescent Aluminium				
836461	300	150	Class C	1 / Pack
836464	400	200	Class C	1 / Pack

PHOTOLUMINESCENT SIGNS WITH TEXT



Order Ref.	Width (mm)	Height (mm)	Class	Legend	Total Qty/ Pack
Class B Photoluminescent Polyester					
834735	300	150	Class B	Exit	1 / Pack
834905	300	150	Class B	Fire exit	1 / Pack
834736	450	150	Class B	Exit	1 / Pack
834906	450	150	Class B	Fire exit	1 / Pack
Class C Photoluminescent Polyester					
834907	300	150	Class C	Fire exit	1 / Pack
834908	450	150	Class C	Fire exit	1 / Pack
Class B Photoluminescent Polypropylene					
834731	300	150	Class B	Exit	1 / Pack
834901	300	150	Class B	Fire exit	1 / Pack
834732	450	150	Class B	Exit	1 / Pack
834902	450	150	Class B	Fire exit	1 / Pack
Class C Photoluminescent Polypropylene					
834903	300	150	Class C	Fire exit	1 / Pack
834904	450	150	Class C	Fire exit	1 / Pack
Class C Photoluminescent Aluminium					
834899	300	150	Class C	Fire exit	1 / Pack
834900	450	150	Class C	Fire exit	1 / Pack

BI-DIRECTIONAL PHOTOLUMINESCENT SIGNS



Order Ref.	Width (mm)	Height (mm)	Layout	Class	Total Qty/ Pack
Class B Photoluminescent Polyvinylchloride					
836505	303	151	Bi-directional	Class B	1 / Pack

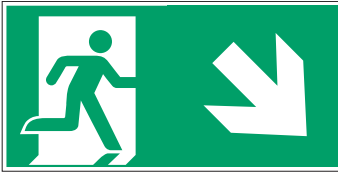

E002/A135 : EMERGENCY EXIT (RIGHT)

The evacuation signboard with a downwards pointing arrow is to be used to indicate a staircase. To indicate the forward to the right direction, the “top right-hand corner arrow will be favoured.



SIGNS

Order Ref.	Width (mm)	Height (mm)	Total Qty/ Pack
Laminated Polyester			
139224	210	105	1 / Pack
138887	297	148	1 / Pack
138870	400	200	1 / Pack
Polypropylene			
138871	210	105	1 / Pack
138927	297	148	1 / Pack
138928	400	200	1 / Pack
Aluminium			
138945	297	148	1 / Pack

PHOTOLUMINESCENT SIGNS WITH TEXT



Order Ref.	Width (mm)	Height (mm)	Class	Legend	Total Qty/ Pack
Class B Photoluminescent Polyester					
834718	300	150	Class B	Exit	1 / Pack
834782	300	150	Class B	Fire exit	1 / Pack
834719	450	150	Class B	Exit	1 / Pack
834783	450	150	Class B	Fire exit	1 / Pack
Class C Photoluminescent Polyester					
834784	300	150	Class C	Fire exit	1 / Pack
834880	450	150	Class C	Fire exit	1 / Pack
Class B Photoluminescent Polypropylene					
834713	300	150	Class B	Exit	1 / Pack
834777	300	150	Class B	Fire exit	1 / Pack
834714	450	150	Class B	Exit	1 / Pack
834779	450	150	Class B	Fire exit	1 / Pack
Class C Photoluminescent Polypropylene					
834780	300	150	Class C	Fire exit	1 / Pack
834781	450	150	Class C	Fire exit	1 / Pack



PHOTOLUMINESCENT SIGNS

Order Ref.	Width (mm)	Height (mm)	Class	Total Qty/ Pack
Class B Photoluminescent Polyester				
836483	150	75	Class B	1 / Pack
834422	300	150	Class B	1 / Pack
834423	600	300	Class B	1 / Pack
Class C Photoluminescent Polyester				
836857	300	150	Class C	1 / Pack
Class B Photoluminescent Polypropylene				
834415	300	150	Class B	1 / Pack
834416	600	300	Class B	1 / Pack
Class C Photoluminescent Aluminium				
836856	300	150	Class C	1 / Pack
139256	400	200	Class C	1 / Pack



E002/A180 : EMERGENCY EXIT (RIGHT)

The downward-pointing arrow evacuation symbol can be used where there is a staircase. To indicate that people should go “straight ahead or through a door, the upward-pointing arrow will be favoured to avoid any confusion.



SIGNS

Order Ref.	Width (mm)	Height (mm)	Total Qty/ Pack
Laminated Polyester			
138856	400	200	1 / Pack
Polypropylene			
138857	210	105	1 / Pack
138916	297	148	1 / Pack
138917	400	200	1 / Pack

PHOTOLUMINESCENT SIGNS WITH TEXT



Order Ref.	Width (mm)	Height (mm)	Class	Legend	Total Qty/ Pack
Class B Photoluminescent Polyester					
834721	300	150	Class B	Exit	1 / Pack
834887	300	150	Class B	Fire exit	1 / Pack
834722	450	150	Class B	Exit	1 / Pack
834742	450	150	Class B	Exit for emergency use only	1 / Pack
834888	450	150	Class B	Fire exit	1 / Pack
Class C Photoluminescent Polyester					
834889	300	150	Class C	Fire exit	1 / Pack
834890	450	150	Class C	Fire exit	1 / Pack
Class B Photoluminescent Polypropylene					
834883	300	150	Class B	Fire exit	1 / Pack
834720	450	150	Class B	Exit	1 / Pack
834741	450	150	Class B	Exit for emergency use only	1 / Pack
834884	450	150	Class B	Fire exit	1 / Pack
Class C Photoluminescent Polypropylene					
834885	300	150	Class C	Fire exit	1 / Pack
834886	450	150	Class C	Fire exit	1 / Pack
Class C Photoluminescent Aluminium					
834881	300	150	Class C	Fire exit	1 / Pack
834882	450	150	Class C	Fire exit	1 / Pack



PHOTOLUMINESCENT SIGNS

Order Ref.	Width (mm)	Height (mm)	Class	Total Qty/ Pack
Class B Photoluminescent Polyester				
836490	150	75	Class B	1 / Pack
834430	300	150	Class B	1 / Pack
834433	600	300	Class B	1 / Pack
Class C Photoluminescent Polyester				
836457	300	150	Class C	1 / Pack
836458	400	200	Class C	1 / Pack
Class B Photoluminescent Polypropylene				
834426	300	150	Class B	1 / Pack
834427	600	300	Class B	1 / Pack
Class C Photoluminescent Polypropylene				
834428	300	150	Class C	1 / Pack
Class C Photoluminescent Self-adhesive Polypropylene				
836459	300	150	Class C	1 / Pack
836460	400	200	Class C	1 / Pack
Class C Photoluminescent Aluminium				
836455	300	150	Class C	1 / Pack
836456	400	200	Class C	1 / Pack

i For all material properties and applications, see pages 4-5

A045 : DIRECTION ARROW 45°, TOP RIGHT CORNER

Arrows should always be used in conjunction with emergency exit pictograms.

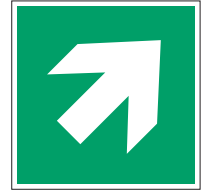

SIGNS

Order Ref.	Width (mm)	Height (mm)	Total Qty/ Pack
Laminated Polyester			
814382	100	100	1 / Pack
814383	148	148	1 / Pack
814384	200	200	1 / Pack
814385	250	250	1 / Pack
814387	315	315	1 / Pack
814388	400	400	1 / Pack
Polypropylene			
814390	100	100	1 / Pack
814391	148	148	1 / Pack
814392	200	200	1 / Pack
814393	250	250	1 / Pack
814395	315	315	1 / Pack
814396	400	400	1 / Pack
Aluminium			
814397	100	100	1 / Pack
814398	200	200	1 / Pack



PHOTOLUMINESCENT SIGNS

Order Ref.	Width (mm)	Height (mm)	Class	Total Qty/ Pack
Class B Photoluminescent Polyester				
836434	150	150	Class B	1 / Pack
836435	200	200	Class B	1 / Pack
Class C Photoluminescent Polyester				
834327	150	150	Class C	1 / Pack
834329	200	200	Class C	1 / Pack
Class B Photoluminescent Polypropylene				
836431	150	150	Class B	1 / Pack
836432	200	200	Class B	1 / Pack
836433	300	300	Class B	1 / Pack
Class C Photoluminescent Self-adhesive Polypropylene				
836436	150	150	Class C	1 / Pack
836437	200	200	Class C	1 / Pack
Class C Photoluminescent Aluminium				
834324	150	150	Class C	1 / Pack
834325	200	200	Class C	1 / Pack

FLOOR MARKING

Order Ref.	Width (mm)	Height (mm)	Total Qty/ Pack
Anti-skid Laminated Polyester			
814389	500	500	1 / Pack



PICTOGRAMS ON ROLLS

Order Ref.	Width (mm)	Height (mm)	Total Qty/ Pack
Laminated Polyester			
814381	100	100	250 / Roll

MINI-PICTOGRAMS

Order Ref.	Width (mm)	Height (mm)	Total Qty/ Pack
Vinyl			
814380	10	10	96 / Pack



Arrows should always be used in conjunction with emergency exit pictograms.



For all material properties and applications, see pages 4-5



A090 : DIRECTION ARROW 90°, TO THE RIGHT

Arrows are not included in the EN ISO 7010 standard and must always be used jointly with emergency exit pictograms.



SIGNS

Order Ref.	Width (mm)	Height (mm)	Total Qty/ Pack
Laminated Polyester			
814409	100	100	1 / Pack
814410	148	148	1 / Pack
814411	200	200	1 / Pack
814412	250	250	1 / Pack
814414	315	315	1 / Pack
Polypropylene			
814417	100	100	1 / Pack
814418	148	148	1 / Pack
814419	200	200	1 / Pack
814420	250	250	1 / Pack
814422	315	315	1 / Pack
814423	400	400	1 / Pack
Aluminium			
814424	100	100	1 / Pack
814425	200	200	1 / Pack

FLOOR MARKING

Order Ref.	Width (mm)	Height (mm)	Total Qty/ Pack
Anti-skid Laminated Polyester			
814416	500	500	1 / Pack

MINI-PICTOGRAMS

Order Ref.	Width (mm)	Height (mm)	Total Qty/ Pack
Vinyl			
814407	10	10	96 / Pack



PICTOGRAMS ON ROLLS

Order Ref.	Width (mm)	Height (mm)	Total Qty/ Pack
Laminated Polyester			
814408	100	100	250 / Roll



PHOTOLUMINESCENT SIGNS

Order Ref.	Width (mm)	Height (mm)	Class	Total Qty/ Pack
Class B Photoluminescent Polyester				
834345	150	150	Class B	1 / Pack
834347	200	200	Class B	1 / Pack
834349	300	300	Class B	1 / Pack
Class C Photoluminescent Polyester				
834351	150	150	Class C	1 / Pack
834353	200	200	Class C	1 / Pack
Class B Photoluminescent Polypropylene				
834338	150	150	Class B	1 / Pack
834342	200	200	Class B	1 / Pack
834343	300	300	Class B	1 / Pack
Class C Photoluminescent Polypropylene				
834344	200	200	Class C	1 / Pack
Class C Photoluminescent Self-adhesive Polypropylene				
836442	150	150	Class C	1 / Pack
836443	200	200	Class C	1 / Pack
Class C Photoluminescent Aluminium				
834331	150	150	Class C	1 / Pack
834337	200	200	Class C	1 / Pack

BI-DIRECTIONAL SIGNS

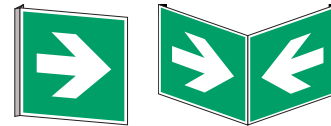

Bi-directional

Panoramic

Order Ref.	Width (mm)	Height (mm)	Layout	Total Qty/ Pack
Polyvinylchloride				
814426	151	151	Bi-directional	1 / Pack
814427	203	203	Bi-directional	1 / Pack
814428	253	253	Bi-directional	1 / Pack
814429	318	318	Bi-directional	1 / Pack



Arrows are not included in the EN ISO 7010 standard and must always be used jointly with emergency exit pictograms.

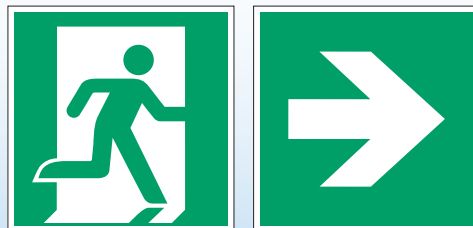

A135 : DIRECTION ARROW 135°, DOWN RIGHT CORNER

The downwards pointing arrow is to be used only where there are stairs in order to avoid any possible confusion. To indicate that people should proceed in a diagonal direction, the "top right-hand corner or "top left-hand corner arrow is to be favoured.

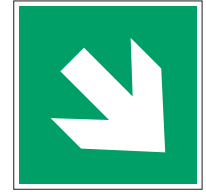

PHOTOLUMINESCENT SIGNS

Order Ref.	Width (mm)	Height (mm)	Class	Total Qty/Pack
Class B Photoluminescent Polyester				
836369	150	150	Class B	1 / Pack
836370	200	200	Class B	1 / Pack
Class B Photoluminescent Polypropylene				
836367	150	150	Class B	1 / Pack
836368	200	200	Class B	1 / Pack

A270 : DIRECTION ARROW 270°, TO THE LEFT

Arrows are not included in the EN ISO 7010 standard and must always be used jointly with emergency exit pictograms.



PHOTOLUMINESCENT SIGNS

Order Ref.	Width (mm)	Height (mm)	Class	Total Qty/Pack
Class B Photoluminescent Polyester				
836414	200	200	Class B	1 / Pack
Class B Photoluminescent Polypropylene				
836412	200	200	Class B	1 / Pack
836413	300	300	Class B	1 / Pack



Arrows are not included in the EN ISO 7010 standard and must always be used jointly with emergency exit pictograms.





E003 : FIRST AID

The cross symbol indicates the presence of first aid equipment, sometimes located in dedicated premises identified by this symbol.



SIGNS

Order Ref.	Width (mm)	Height (mm)	Total Qty/ Pack
Laminated Polyester			
814595	100	100	1 / Pack
814596	148	148	1 / Pack
814597	200	200	1 / Pack
814598	250	250	1 / Pack
814600	315	315	1 / Pack
814601	400	400	1 / Pack
Polypropylene			
814604	148	148	1 / Pack
814605	200	200	1 / Pack
814606	250	250	1 / Pack
814608	315	315	1 / Pack
814609	400	400	1 / Pack
Aluminium			
814610	100	100	1 / Pack
814611	200	200	1 / Pack



Bi-directional

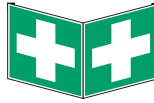

Panoramic



Bi-directional



Panoramic

FLOOR MARKING

Order Ref.	Width (mm)	Height (mm)	Total Qty/ Pack
Anti-skid Laminated Polyester			
814602	500	500	1 / Pack

MINI-PICTOGRAMS

Order Ref.	Width (mm)	Height (mm)	Total Qty/ Pack
Laminated Polyester			
138975	18	18	40 / Pack
Vinyl			
814593	10	10	96 / Pack



PHOTOLUMINESCENT SIGNS

Order Ref.	Width (mm)	Height (mm)	Class	Total Qty/ Pack
Class B Photoluminescent Polyester				
836536	150	150	Class B	1 / Pack
Class C Photoluminescent Polyester				
834497	150	150	Class C	1 / Pack
834498	200	200	Class C	1 / Pack
836866	300	300	Class C	1 / Pack
Class B Photoluminescent Polypropylene				
836535	150	150	Class B	1 / Pack
Class C Photoluminescent Self-adhesive Polypropylene				
836537	200	200	Class C	1 / Pack
Class C Photoluminescent Aluminium				
834493	150	150	Class C	1 / Pack
834494	200	200	Class C	1 / Pack
134664	300	300	Class C	1 / Pack



PICTOGRAMS ON ROLLS

Order Ref.	Width (mm)	Height (mm)	Total Qty/ Pack
Laminated Polyester			
814594	100	100	250 / Roll

BRADY
Customise-it

See page 196 to order your custom-made signs.



For all material properties and applications, see pages 4-5

BI-DIRECTIONAL SIGNS

Order Ref.	Width (mm)	Height (mm)	Layout	Total Qty/ Pack
Polyvinylchloride				
814612	151	151	Bi-directional	1 / Pack
814613	203	203	Bi-directional	1 / Pack
814614	253	253	Bi-directional	1 / Pack
814615	318	318	Bi-directional	1 / Pack
814616	151	151	Panoramic	1 / Pack
814617	203	203	Panoramic	1 / Pack
814618	253	253	Panoramic	1 / Pack
814619	318	318	Panoramic	1 / Pack

BI-DIRECTIONAL PHOTOLUMINESCENT SIGNS

Order Ref.	Width (mm)	Height (mm)	Layout	Class	Total Qty/ Pack
Class C Photoluminescent Polyvinylchloride					
836860	151	151	Bi-directional	Class C	1 / Pack
836861	203	203	Bi-directional	Class C	1 / Pack
836858	303	303	Bi-directional	Class C	1 / Pack
836859	151	151	Panoramic	Class C	1 / Pack
836868	203	203	Panoramic	Class C	1 / Pack
836870	303	303	Panoramic	Class C	1 / Pack
134668	318	318	Panoramic	Class C	1 / Pack

SIGNS WITH TEXT



Order Ref.	Width (mm)	Height (mm)	Layout	Legend	Total Qty/ Pack
Laminated Polyester					
814667	150	50	Landscape	First aid	1 / Pack
814668	297	74	Landscape	First aid	1 / Pack
814669	297	105	Landscape	First aid	1 / Pack
814670	450	150	Landscape	First aid	1 / Pack
814671	600	200	Landscape	First aid	1 / Pack
814664	148	210	Portrait	First aid	1 / Pack
814665	210	297	Portrait	First aid	1 / Pack
814666	297	420	Portrait	First aid	1 / Pack
Polypropylene					
814675	150	50	Landscape	First aid	1 / Pack
814676	297	74	Landscape	First aid	1 / Pack
814677	297	105	Landscape	First aid	1 / Pack
814678	450	150	Landscape	First aid	1 / Pack
814679	600	200	Landscape	First aid	1 / Pack
814672	148	210	Portrait	First aid	1 / Pack
814673	210	297	Portrait	First aid	1 / Pack
814674	297	420	Portrait	First aid	1 / Pack
Aluminium					
814683	150	50	Landscape	First aid	1 / Pack
814684	297	105	Landscape	First aid	1 / Pack
814685	450	150	Landscape	First aid	1 / Pack
814680	148	210	Portrait	First aid	1 / Pack
814681	210	297	Portrait	First aid	1 / Pack
814682	297	420	Portrait	First aid	1 / Pack

PHOTOLUMINESCENT SIGNS WITH TEXT



Order Ref.	Width (mm)	Height (mm)	Class	Legend	Total Qty/ Pack
Class B Photoluminescent Polyester					
834492	250	100	Class B	First aid	1 / Pack
Class B Photoluminescent Polypropylene					
834491	250	100	Class B	First aid	1 / Pack

Complies with EN ISO 7010

E004 : EMERGENCY TELEPHONE

Emergency telephones must be clearly marked to ensure emergency services can be notified quickly when necessary.



SIGNS

Order Ref.	Width (mm)	Height (mm)	Total Qty/ Pack
Laminated Polyester			
814754	100	100	1 / Pack
814755	148	148	1 / Pack
814756	200	200	1 / Pack
814757	250	250	1 / Pack
814759	315	315	1 / Pack
814760	400	400	1 / Pack
Polypropylene			
814762	100	100	1 / Pack
814763	148	148	1 / Pack
814764	200	200	1 / Pack
814765	250	250	1 / Pack
814767	315	315	1 / Pack
814768	400	400	1 / Pack
Aluminium			
814769	100	100	1 / Pack
814770	200	200	1 / Pack

FLOOR MARKING

Order Ref.	Width (mm)	Height (mm)	Total Qty/ Pack
Anti-skid Laminated Polyester			
814761	500	500	1 / Pack

MINI-PICTOGRAMS

Order Ref.	Width (mm)	Height (mm)	Total Qty/ Pack
Laminated Polyester			
138976	18	18	40 / Pack
Vinyl			
814752	10	10	96 / Pack



PHOTOLUMINESCENT SIGNS

Order Ref.	Width (mm)	Height (mm)	Class	Total Qty/ Pack
Class B Photoluminescent Polyester				
836541	150	150	Class B	1 / Pack
836542	200	200	Class B	1 / Pack
Class C Photoluminescent Polyester				
834503	150	150	Class C	1 / Pack
834504	200	200	Class C	1 / Pack
Class B Photoluminescent Polypropylene				
836538	150	150	Class B	1 / Pack
836539	200	200	Class B	1 / Pack
836540	300	300	Class B	1 / Pack
Class C Photoluminescent Aluminium				
834499	150	150	Class C	1 / Pack
834502	200	200	Class C	1 / Pack



PICTOGRAMS ON ROLLS

Order Ref.	Width (mm)	Height (mm)	Total Qty/ Pack
Laminated Polyester			
814753	100	100	250 / Roll

BI-DIRECTIONAL SIGNS



Bi-directional



Panoramic

Order Ref.	Width (mm)	Height (mm)	Layout	Total Qty/ Pack
Polyvinylchloride				
814771	151	151	Bi-directional	1 / Pack
814772	203	203	Bi-directional	1 / Pack
814773	253	253	Bi-directional	1 / Pack
814774	318	318	Bi-directional	1 / Pack
814775	151	151	Panoramic	1 / Pack
814776	203	203	Panoramic	1 / Pack
814777	253	253	Panoramic	1 / Pack
814778	318	318	Panoramic	1 / Pack

SIGNS WITH TEXT



Order Ref.	Width (mm)	Height (mm)	Layout	Legend	Total Qty/ Pack
Laminated Polyester					
814826	150	50	Landscape	Emergency telephone	1 / Pack
814827	297	74	Landscape	Emergency telephone	1 / Pack
814828	297	105	Landscape	Emergency telephone	1 / Pack
814829	450	150	Landscape	Emergency telephone	1 / Pack
814830	600	200	Landscape	Emergency telephone	1 / Pack
814823	148	210	Portrait	Emergency telephone	1 / Pack
814824	210	297	Portrait	Emergency telephone	1 / Pack
814825	297	420	Portrait	Emergency telephone	1 / Pack
Polypropylene					
814834	150	50	Landscape	Emergency telephone	1 / Pack
814835	297	74	Landscape	Emergency telephone	1 / Pack
814836	297	105	Landscape	Emergency telephone	1 / Pack
814837	450	150	Landscape	Emergency telephone	1 / Pack
814838	600	200	Landscape	Emergency telephone	1 / Pack
814831	148	210	Portrait	Emergency telephone	1 / Pack
814832	210	297	Portrait	Emergency telephone	1 / Pack
814833	297	420	Portrait	Emergency telephone	1 / Pack
Aluminium					
814842	150	50	Landscape	Emergency telephone	1 / Pack
814843	297	105	Landscape	Emergency telephone	1 / Pack
814844	450	150	Landscape	Emergency telephone	1 / Pack
814839	148	210	Portrait	Emergency telephone	1 / Pack
814840	210	297	Portrait	Emergency telephone	1 / Pack
814841	297	420	Portrait	Emergency telephone	1 / Pack

BRADY
Customise-it

See page 196 to order your custom-made signs.



For all material properties and applications, see pages 4-5



E007 : EVACUATION ASSEMBLY POINT

In case of an evacuation it is of vital importance everybody gathers at the assembly point a.s.a.p. to facilitate an efficient headcount.



SIGNS

Order Ref.	Width (mm)	Height (mm)	Total Qty/ Pack
Laminated Polyester			
814913	100	100	1 / Pack
814914	148	148	1 / Pack
814915	200	200	1 / Pack
814916	250	250	1 / Pack
814918	315	315	1 / Pack
814919	400	400	1 / Pack
Polypropylene			
814921	100	100	1 / Pack
814922	148	148	1 / Pack
814923	200	200	1 / Pack
814924	250	250	1 / Pack
814926	315	315	1 / Pack
814927	400	400	1 / Pack
Aluminium			
814928	100	100	1 / Pack
814929	200	200	1 / Pack
138853	400	400	1 / Pack
138854	600	600	1 / Pack

FLOOR MARKING

Order Ref.	Width (mm)	Height (mm)	Total Qty/ Pack
Anti-skid Laminated Polyester			
814920	500	500	1 / Pack

MINI-PICTOGRAMS

Order Ref.	Width (mm)	Height (mm)	Total Qty/ Pack
Vinyl			
814911	10	10	96 / Pack

SIGNS WITH TEXT



Order Ref.	Width (mm)	Height (mm)	Layout	Legend	Total Qty/ Pack
Laminated Polyester					
814985	150	50	Landscape	Evacuation assembly point	1 / Pack
814986	297	74	Landscape	Evacuation assembly point	1 / Pack
814987	297	105	Landscape	Evacuation assembly point	1 / Pack
814988	450	150	Landscape	Evacuation assembly point	1 / Pack
814989	600	200	Landscape	Evacuation assembly point	1 / Pack
814982	148	210	Portrait	Evacuation assembly point	1 / Pack
814983	210	297	Portrait	Evacuation assembly point	1 / Pack
814984	297	420	Portrait	Evacuation assembly point	1 / Pack
Polypropylene					
814993	150	50	Landscape	Evacuation assembly point	1 / Pack
814994	297	74	Landscape	Evacuation assembly point	1 / Pack
814995	297	105	Landscape	Evacuation assembly point	1 / Pack
814996	450	150	Landscape	Evacuation assembly point	1 / Pack
814997	600	200	Landscape	Evacuation assembly point	1 / Pack
814990	148	210	Portrait	Evacuation assembly point	1 / Pack
814991	210	297	Portrait	Evacuation assembly point	1 / Pack
814992	297	420	Portrait	Evacuation assembly point	1 / Pack
Aluminium					
815001	150	50	Landscape	Evacuation assembly point	1 / Pack
815002	297	105	Landscape	Evacuation assembly point	1 / Pack
815003	450	150	Landscape	Evacuation assembly point	1 / Pack
814998	148	210	Portrait	Evacuation assembly point	1 / Pack
814999	210	297	Portrait	Evacuation assembly point	1 / Pack
815000	297	420	Portrait	Evacuation assembly point	1 / Pack

PHOTOLUMINESCENT SIGNS



Order Ref.	Width (mm)	Height (mm)	Class	Total Qty/ Pack
Class C Photoluminescent Polyester				
834544	150	150	Class C	1 / Pack
834545	200	200	Class C	1 / Pack
836876	400	400	Class C	1 / Pack
836878	600	600	Class C	1 / Pack
Class C Photoluminescent Aluminium				
834542	150	150	Class C	1 / Pack
834543	200	200	Class C	1 / Pack
836872	400	400	Class C	1 / Pack
836875	600	600	Class C	1 / Pack

PHOTOLUMINESCENT SIGNS WITH TEXT



Order Ref.	Width (mm)	Height (mm)	Layout	Class	Legend	Total Qty/ Pack
Class B Photoluminescent Polypropylene						
834521	100	250	Portrait	Class B	Assembly point	1 / Pack
834536	100	200	Portrait	Class B	Your fire assembly point is	1 / Pack
834537	150	300	Portrait	Class B	Your fire assembly point is	1 / Pack
834523	250	300	Portrait	Class B	Assembly point	1 / Pack
834510	300	400	Portrait	Class B	Fire assembly point A	1 / Pack
834514	300	400	Portrait	Class B	Fire assembly point B	1 / Pack
834517	300	400	Portrait	Class B	Fire assembly point C	1 / Pack
834519	300	400	Portrait	Class B	Fire assembly point D	1 / Pack
834526	300	400	Portrait	Class B	Assembly point	1 / Pack
834531	450	600	Portrait	Class B	Assembly point	1 / Pack
Class B Photoluminescent Polyester						
834540	200	100	Landscape	Class B	Your fire assembly point is	1 / Pack
834541	300	150	Landscape	Class B	Your fire assembly point is	1 / Pack
834532	100	250	Portrait	Class B	Assembly point	1 / Pack
834533	250	300	Portrait	Class B	Assembly point	1 / Pack
834511	300	400	Portrait	Class B	Fire assembly point A	1 / Pack
834515	300	400	Portrait	Class B	Fire assembly point B	1 / Pack
834518	300	400	Portrait	Class B	Fire assembly point C	1 / Pack
834520	300	400	Portrait	Class B	Fire assembly point D	1 / Pack
834534	300	400	Portrait	Class B	Assembly point	1 / Pack
834535	450	600	Portrait	Class B	Assembly point	1 / Pack



PICTOGRAMS ON ROLLS

Order Ref.	Width (mm)	Height (mm)	Total Qty/ Pack
Laminated Polyester			
814912	100	100	250 / Roll

BI-DIRECTIONAL SIGNS

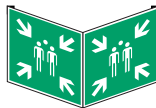

Bi-directional

Panoramic

Order Ref.	Width (mm)	Height (mm)	Layout	Total Qty/ Pack
Polyvinylchloride				
814930	151	151	Bi-directional	1 / Pack
814931	203	203	Bi-directional	1 / Pack
814932	253	253	Bi-directional	1 / Pack
814933	318	318	Bi-directional	1 / Pack
814934	151	151	Panoramic	1 / Pack
814935	203	203	Panoramic	1 / Pack
814936	253	253	Panoramic	1 / Pack
814937	318	318	Panoramic	1 / Pack

A270/E007 : EVACUATION ASSEMBLY POINT

The arrow acts as a guide towards the designated assembly point following an evacuation.



PHOTOLUMINESCENT SIGNS

Order Ref.	Width (mm)	Height (mm)	Class	Total Qty/ Pack
Class B Photoluminescent Polyester				
834262	300	150	Class B	1 / Pack
Class B Photoluminescent Polypropylene				
834261	300	150	Class B	1 / Pack

Complies with EN ISO 7010

E008 : BREAK TO OBTAIN ACCESS

In some cases glass or a seal needs to be broken to use an emergency exit. It is important to indicate this to make sure it's clear what needs to be done in case of an evacuation.



SIGNS

Order Ref.	Width (mm)	Height (mm)	Total Qty/ Pack
Laminated Polyester			
815072	100	100	1 / Pack
815073	148	148	1 / Pack
815074	200	200	1 / Pack
815075	250	250	1 / Pack
815077	315	315	1 / Pack
815078	400	400	1 / Pack
Polypropylene			
815080	100	100	1 / Pack
815081	148	148	1 / Pack
815082	200	200	1 / Pack
815083	250	250	1 / Pack
815085	315	315	1 / Pack
815086	400	400	1 / Pack
Aluminium			
815087	100	100	1 / Pack
815088	200	200	1 / Pack

FLOOR MARKING

Order Ref.	Width (mm)	Height (mm)	Total Qty/ Pack
Anti-skid Laminated Polyester			
815079	500	500	1 / Pack

MINI-PICTOGRAMS

Order Ref.	Width (mm)	Height (mm)	Total Qty/ Pack
Vinyl			
815070	10	10	96 / Pack



PHOTOLUMINESCENT SIGNS

Order Ref.	Width (mm)	Height (mm)	Class	Total Qty/ Pack
Class C Photoluminescent Polyester				
834566	150	150	Class C	1 / Pack
834567	200	200	Class C	1 / Pack
Class C Photoluminescent Aluminium				
834564	150	150	Class C	1 / Pack
834565	200	200	Class C	1 / Pack



PICTOGRAMS ON ROLLS

Order Ref.	Width (mm)	Height (mm)	Total Qty/ Pack
Laminated Polyester			
815071	100	100	250 / Roll

BI-DIRECTIONAL SIGNS



Bi-directional



Panoramic

Order Ref.	Width (mm)	Height (mm)	Layout	Total Qty/ Pack
Polyvinylchloride				
815089	151	151	Bi-directional	1 / Pack
815090	203	203	Bi-directional	1 / Pack
815091	253	253	Bi-directional	1 / Pack
815092	318	318	Bi-directional	1 / Pack
815093	151	151	Panoramic	1 / Pack
815094	203	203	Panoramic	1 / Pack
815095	253	253	Panoramic	1 / Pack
815096	318	318	Panoramic	1 / Pack

SIGNS WITH TEXT



Order Ref.	Width (mm)	Height (mm)	Layout	Legend	Total Qty/ Pack
Laminated Polyester					
815144	150	50	Landscape	Break to obtain access	1 / Pack
815145	297	74	Landscape	Break to obtain access	1 / Pack
815146	297	105	Landscape	Break to obtain access	1 / Pack
815147	450	150	Landscape	Break to obtain access	1 / Pack
815148	600	200	Landscape	Break to obtain access	1 / Pack
815141	148	210	Portrait	Break to obtain access	1 / Pack
815142	210	297	Portrait	Break to obtain access	1 / Pack
815143	297	420	Portrait	Break to obtain access	1 / Pack
Polypropylene					
815152	150	50	Landscape	Break to obtain access	1 / Pack
815153	297	74	Landscape	Break to obtain access	1 / Pack
815154	297	105	Landscape	Break to obtain access	1 / Pack
815155	450	150	Landscape	Break to obtain access	1 / Pack
815156	600	200	Landscape	Break to obtain access	1 / Pack
815149	148	210	Portrait	Break to obtain access	1 / Pack
815150	210	297	Portrait	Break to obtain access	1 / Pack
815151	297	420	Portrait	Break to obtain access	1 / Pack
Aluminium					
815160	150	50	Landscape	Break to obtain access	1 / Pack
815161	297	105	Landscape	Break to obtain access	1 / Pack
815162	450	150	Landscape	Break to obtain access	1 / Pack
815157	148	210	Portrait	Break to obtain access	1 / Pack
815158	210	297	Portrait	Break to obtain access	1 / Pack
815159	297	420	Portrait	Break to obtain access	1 / Pack

BRADY
Customise-it

See page 196 to order your custom-made signs.



For all material properties and applications, see pages 4-5



E009 : DOCTOR

With this sign the company doctor's practice can be clearly indicated.



SIGNS

Order Ref.	Width (mm)	Height (mm)	Total Qty/ Pack
Laminated Polyester			
815231	100	100	1 / Pack
815232	148	148	1 / Pack
815233	200	200	1 / Pack
815234	250	250	1 / Pack
815236	315	315	1 / Pack
815237	400	400	1 / Pack
Polypropylene			
815239	100	100	1 / Pack
815240	148	148	1 / Pack
815241	200	200	1 / Pack
815242	250	250	1 / Pack
815244	315	315	1 / Pack
815245	400	400	1 / Pack
Aluminium			
815246	100	100	1 / Pack
815247	200	200	1 / Pack

FLOOR MARKING

Order Ref.	Width (mm)	Height (mm)	Total Qty/ Pack
Anti-skid Laminated Polyester			
815238	500	500	1 / Pack

MINI-PICTOGRAMS

Order Ref.	Width (mm)	Height (mm)	Total Qty/ Pack
Vinyl			
815229	10	10	96 / Pack



PHOTOLUMINESCENT SIGNS

Order Ref.	Width (mm)	Height (mm)	Class	Total Qty/ Pack
Class C Photoluminescent Polyester				
834570	150	150	Class C	1 / Pack
834572	200	200	Class C	1 / Pack
Class C Photoluminescent Aluminium				
834568	150	150	Class C	1 / Pack
834569	200	200	Class C	1 / Pack



PICTOGRAMS ON ROLLS

Order Ref.	Width (mm)	Height (mm)	Total Qty/ Pack
Laminated Polyester			
815230	100	100	250 / Roll

BI-DIRECTIONAL SIGNS



Bi-directional



Panoramic

Order Ref.	Width (mm)	Height (mm)	Layout	Total Qty/ Pack
Polyvinylchloride				
815248	151	151	Bi-directional	1 / Pack
815249	203	203	Bi-directional	1 / Pack
815250	253	253	Bi-directional	1 / Pack
815251	318	318	Bi-directional	1 / Pack
815252	151	151	Panoramic	1 / Pack
815253	203	203	Panoramic	1 / Pack
815254	253	253	Panoramic	1 / Pack
815255	318	318	Panoramic	1 / Pack

SIGNS WITH TEXT



Order Ref.	Width (mm)	Height (mm)	Layout	Legend	Total Qty/ Pack
Laminated Polyester					
815303	150	50	Landscape	Doctor	1 / Pack
815304	297	74	Landscape	Doctor	1 / Pack
815305	297	105	Landscape	Doctor	1 / Pack
815306	450	150	Landscape	Doctor	1 / Pack
815307	600	200	Landscape	Doctor	1 / Pack
815300	148	210	Portrait	Doctor	1 / Pack
815301	210	297	Portrait	Doctor	1 / Pack
815302	297	420	Portrait	Doctor	1 / Pack
Polypropylene					
815311	150	50	Landscape	Doctor	1 / Pack
815312	297	74	Landscape	Doctor	1 / Pack
815313	297	105	Landscape	Doctor	1 / Pack
815314	450	150	Landscape	Doctor	1 / Pack
815315	600	200	Landscape	Doctor	1 / Pack
815308	148	210	Portrait	Doctor	1 / Pack
815309	210	297	Portrait	Doctor	1 / Pack
815310	297	420	Portrait	Doctor	1 / Pack
Aluminium					
815319	150	50	Landscape	Doctor	1 / Pack
815320	297	105	Landscape	Doctor	1 / Pack
815321	450	150	Landscape	Doctor	1 / Pack
815316	148	210	Portrait	Doctor	1 / Pack
815317	210	297	Portrait	Doctor	1 / Pack
815318	297	420	Portrait	Doctor	1 / Pack

BRADY
Customise-it

See page 196 to order your custom-made signs.

i For all material properties and applications, see pages 4-5

Complies with EN ISO 7010

E010 : AUTOMATED EXTERNAL HEART DEFIBRILLATOR

Automated external heart defibrillators must be clearly indicated to facilitate a quick intervention in case of cardiac arrest.

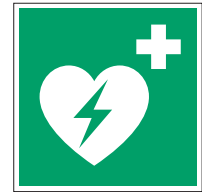

SIGNS

Order Ref.	Width (mm)	Height (mm)	Total Qty/ Pack
Laminated Polyester			
815390	100	100	1 / Pack
815391	148	148	1 / Pack
815392	200	200	1 / Pack
815393	250	250	1 / Pack
815395	315	315	1 / Pack
815396	400	400	1 / Pack
Polypropylene			
815398	100	100	1 / Pack
815399	148	148	1 / Pack
815401	250	250	1 / Pack
815403	315	315	1 / Pack
815404	400	400	1 / Pack
Aluminium			
815405	100	100	1 / Pack
815406	200	200	1 / Pack

MINI-PICTOGRAMS

Order Ref.	Width (mm)	Height (mm)	Total Qty/ Pack
Vinyl			
815388	10	10	96 / Pack

FLOOR MARKING

Order Ref.	Width (mm)	Height (mm)	Total Qty/ Pack
Anti-skid Laminated Polyester			
815397	500	500	1 / Pack



PHOTOLUMINESCENT SIGNS

Order Ref.	Width (mm)	Height (mm)	Class	Total Qty/ Pack
Class B Photoluminescent Polyester				
836546	150	150	Class B	1 / Pack
836547	200	200	Class B	1 / Pack
Class C Photoluminescent Polyester				
834582	150	150	Class C	1 / Pack
834586	200	200	Class C	1 / Pack
Class B Photoluminescent Polypropylene				
836543	150	150	Class B	1 / Pack
836544	200	200	Class B	1 / Pack
836545	300	300	Class B	1 / Pack
Class C Photoluminescent Self-adhesive Polypropylene				
836548	150	150	Class C	1 / Pack
836549	200	200	Class C	1 / Pack
Class C Photoluminescent Aluminium				
834578	150	150	Class C	1 / Pack
834581	200	200	Class C	1 / Pack



PICTOGRAMS ON ROLLS

Order Ref.	Width (mm)	Height (mm)	Total Qty/ Pack
Laminated Polyester			
815389	100	100	250 / Roll

BRADY
Customise-it

See page 196 to order your custom-made signs.

i For all material properties and applications, see pages 4-5



Bi-directional

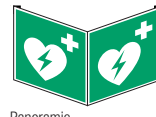

Panoramic

BI-DIRECTIONAL SIGNS

Order Ref.	Width (mm)	Height (mm)	Layout	Total Qty/ Pack
Polyvinylchloride				
815407	151	151	Bi-directional	1 / Pack
815408	203	203	Bi-directional	1 / Pack
815409	253	253	Bi-directional	1 / Pack
815410	318	318	Bi-directional	1 / Pack
815411	151	151	Panoramic	1 / Pack
815412	203	203	Panoramic	1 / Pack
815413	253	253	Panoramic	1 / Pack
815414	318	318	Panoramic	1 / Pack

SIGNS WITH TEXT



Legend



Legend

Order Ref.	Width (mm)	Height (mm)	Layout	Legend	Total Qty/ Pack
Laminated Polyester					
815462	150	50	Landscape	Automated external heart defibrillator	1 / Pack
815463	297	74	Landscape	Automated external heart defibrillator	1 / Pack
815464	297	105	Landscape	Automated external heart defibrillator	1 / Pack
815465	450	150	Landscape	Automated external heart defibrillator	1 / Pack
815466	600	200	Landscape	Automated external heart defibrillator	1 / Pack
815459	148	210	Portrait	Automated external heart defibrillator	1 / Pack
815460	210	297	Portrait	Automated external heart defibrillator	1 / Pack
815461	297	420	Portrait	Automated external heart defibrillator	1 / Pack
Polypropylene					
815470	150	50	Landscape	Automated external heart defibrillator	1 / Pack
815471	297	74	Landscape	Automated external heart defibrillator	1 / Pack
815472	297	105	Landscape	Automated external heart defibrillator	1 / Pack
815473	450	150	Landscape	Automated external heart defibrillator	1 / Pack
815474	600	200	Landscape	Automated external heart defibrillator	1 / Pack
815467	148	210	Portrait	Automated external heart defibrillator	1 / Pack
815468	210	297	Portrait	Automated external heart defibrillator	1 / Pack
815469	297	420	Portrait	Automated external heart defibrillator	1 / Pack
Aluminium					
815478	150	50	Landscape	Automated external heart defibrillator	1 / Pack
815479	297	105	Landscape	Automated external heart defibrillator	1 / Pack
815480	450	150	Landscape	Automated external heart defibrillator	1 / Pack
815475	148	210	Portrait	Automated external heart defibrillator	1 / Pack
815476	210	297	Portrait	Automated external heart defibrillator	1 / Pack
815477	297	420	Portrait	Automated external heart defibrillator	1 / Pack

PHOTOLUMINESCENT SIGNS WITH TEXT



Legend

Order Ref.	Width (mm)	Height (mm)	Class	Legend	Total Qty/ Pack
Class B Photoluminescent Polyester					
834574	250	100	Class B	AED Automated External Defibrillator	1 / Pack
Class B Photoluminescent Polypropylene					
834573	250	100	Class B	AED Automated External Defibrillator	1 / Pack



E011 : EYEWASH STATION

The first 10 to 15 seconds after exposure to a hazardous substance, especially a corrosive substance, are critical. Any delay in treatment may cause serious injury. Eyewash stations provide on-the-spot decontamination, allowing workers to flush away hazardous substances that can cause injury. The location of each eyewash station should be identified with a highly visible sign. Use a standard sign near the station in combination with a panoramic sign placed higher above the station for optimal visibility from all sides.



SIGNS

Order Ref.	Width (mm)	Height (mm)	Total Qty/ Pack
Laminated Polyester			
815549	100	100	1 / Pack
815550	148	148	1 / Pack
815551	200	200	1 / Pack
815552	250	250	1 / Pack
815554	315	315	1 / Pack
815555	400	400	1 / Pack
Polypropylene			
815557	100	100	1 / Pack
815558	148	148	1 / Pack
815559	200	200	1 / Pack
815560	250	250	1 / Pack
815562	315	315	1 / Pack
Aluminium			
815564	100	100	1 / Pack
815565	200	200	1 / Pack

FLOOR MARKING

Order Ref.	Width (mm)	Height (mm)	Total Qty/ Pack
Anti-skid Laminated Polyester			
815556	500	500	1 / Pack

MINI-PICTOGRAMS

Order Ref.	Width (mm)	Height (mm)	Total Qty/ Pack
Laminated Polyester			
138977	18	18	40 / Pack
Vinyl			
815547	10	10	96 / Pack



PHOTOLUMINESCENT SIGNS

Order Ref.	Width (mm)	Height (mm)	Class	Total Qty/ Pack
Class B Photoluminescent Polyester				
836557	150	150	Class B	1 / Pack
836558	200	200	Class B	1 / Pack
Class C Photoluminescent Polyester				
834600	150	150	Class C	1 / Pack
834601	200	200	Class C	1 / Pack
Class B Photoluminescent Polypropylene				
836554	150	150	Class B	1 / Pack
836555	200	200	Class B	1 / Pack
836556	300	300	Class B	1 / Pack
Class C Photoluminescent Self-adhesive Polypropylene				
836559	150	150	Class C	1 / Pack
836560	200	200	Class C	1 / Pack
Class C Photoluminescent Aluminium				
834595	150	150	Class C	1 / Pack
834597	200	200	Class C	1 / Pack



PICTOGRAMS ON ROLLS

Order Ref.	Width (mm)	Height (mm)	Total Qty/ Pack
Laminated Polyester			
815548	100	100	250 / Roll

BRADY
Customise-it

See page 196 to order your custom-made signs.

i For all material properties and applications, see pages 4-5

BI-DIRECTIONAL SIGNS

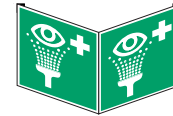

Order Ref.	Width (mm)	Height (mm)	Layout	Total Qty/ Pack
Polyvinylchloride				
815566	151	151	Bi-directional	1 / Pack
815567	203	203	Bi-directional	1 / Pack
815568	253	253	Bi-directional	1 / Pack
815569	318	318	Bi-directional	1 / Pack
815570	151	151	Panoramic	1 / Pack
815571	203	203	Panoramic	1 / Pack
815572	253	253	Panoramic	1 / Pack
815573	318	318	Panoramic	1 / Pack

SIGNS WITH TEXT



Order Ref.	Width (mm)	Height (mm)	Layout	Legend	Total Qty/ Pack
Laminated Polyester					
815621	150	50	Landscape	Eyewash station	1 / Pack
815622	297	74	Landscape	Eyewash station	1 / Pack
815623	297	105	Landscape	Eyewash station	1 / Pack
815624	450	150	Landscape	Eyewash station	1 / Pack
815625	600	200	Landscape	Eyewash station	1 / Pack
815618	148	210	Portrait	Eyewash station	1 / Pack
815619	210	297	Portrait	Eyewash station	1 / Pack
815620	297	420	Portrait	Eyewash station	1 / Pack
Polypropylene					
815629	150	50	Landscape	Eyewash station	1 / Pack
815630	297	74	Landscape	Eyewash station	1 / Pack
815631	297	105	Landscape	Eyewash station	1 / Pack
815632	450	150	Landscape	Eyewash station	1 / Pack
815633	600	200	Landscape	Eyewash station	1 / Pack
815626	148	210	Portrait	Eyewash station	1 / Pack
815627	210	297	Portrait	Eyewash station	1 / Pack
815628	297	420	Portrait	Eyewash station	1 / Pack
Aluminium					
815637	150	50	Landscape	Eyewash station	1 / Pack
815638	297	105	Landscape	Eyewash station	1 / Pack
815639	450	150	Landscape	Eyewash station	1 / Pack
815634	148	210	Portrait	Eyewash station	1 / Pack
815635	210	297	Portrait	Eyewash station	1 / Pack
815636	297	420	Portrait	Eyewash station	1 / Pack

PHOTOLUMINESCENT SIGNS WITH TEXT



Order Ref.	Width (mm)	Height (mm)	Class	Legend	Total Qty/ Pack
Class B Photoluminescent Polyester					
834594	100	250	Class B	Eyewash	1 / Pack
834593	200	100	Class B	Eyewash	1 / Pack
Class B Photoluminescent Polypropylene					
834589	100	250	Class B	Eyewash	1 / Pack
834587	200	100	Class B	Eyewash	1 / Pack

Complies with EN ISO 7010

E012 : SAFETY SHOWER

The first 10 to 15 seconds after exposure to a hazardous substance, especially a corrosive substance, are critical. Any delay in treatment may cause serious injury. A safety shower provides on-the-spot decontamination, allowing workers to flush away hazardous substances that can cause injury.

The location of each safety shower should be identified with a highly visible sign. Use a standard sign near the shower in combination with a panoramic sign placed higher above the shower for optimal visibility from all sides.

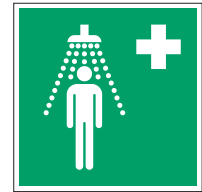

SIGNS

Order Ref.	Width (mm)	Height (mm)	Total Qty/ Pack
Laminated Polyester			
815708	100	100	1 / Pack
815709	148	148	1 / Pack
815710	200	200	1 / Pack
815711	250	250	1 / Pack
815712	300	300	1 / Pack
815714	400	400	1 / Pack
Polypropylene			
815716	100	100	1 / Pack
815717	148	148	1 / Pack
815718	200	200	1 / Pack
815719	250	250	1 / Pack
815720	300	300	1 / Pack
815722	400	400	1 / Pack
Aluminium			
815723	100	100	1 / Pack
815724	200	200	1 / Pack

FLOOR MARKING

Order Ref.	Width (mm)	Height (mm)	Total Qty/ Pack
Anti-skid Laminated Polyester			
815715	500	500	1 / Pack

MINI-PICTOGRAMS

Order Ref.	Width (mm)	Height (mm)	Total Qty/ Pack
Vinyl			
815706	10	10	96 / Pack



PHOTOLUMINESCENT SIGNS

Order Ref.	Width (mm)	Height (mm)	Class	Total Qty/ Pack
Class B Photoluminescent Polyester				
836568	150	150	Class B	1 / Pack
836569	200	200	Class B	1 / Pack
Class C Photoluminescent Polyester				
834606	150	150	Class C	1 / Pack
834607	200	200	Class C	1 / Pack
Class B Photoluminescent Polypropylene				
836565	150	150	Class B	1 / Pack
836566	200	200	Class B	1 / Pack
836567	300	300	Class B	1 / Pack
Class C Photoluminescent Self-adhesive Polypropylene				
836570	150	150	Class C	1 / Pack
Class C Photoluminescent Aluminium				
834602	150	150	Class C	1 / Pack
834605	200	200	Class C	1 / Pack



PICTOGRAMS ON ROLLS

Order Ref.	Width (mm)	Height (mm)	Total Qty/ Pack
Laminated Polyester			
815707	100	100	250 / Roll

BI-DIRECTIONAL SIGNS



Bi-directional



Panoramic

Order Ref.	Width (mm)	Height (mm)	Layout	Total Qty/ Pack
Polyvinylchloride				
815725	151	151	Bi-directional	1 / Pack
815726	203	203	Bi-directional	1 / Pack
815727	253	253	Bi-directional	1 / Pack
815728	318	318	Bi-directional	1 / Pack
815729	151	151	Panoramic	1 / Pack
815730	203	203	Panoramic	1 / Pack
815731	253	253	Panoramic	1 / Pack
815732	318	318	Panoramic	1 / Pack

SIGNS WITH TEXT



Order Ref.	Width (mm)	Height (mm)	Layout	Legend	Total Qty/ Pack
Laminated Polyester					
815780	150	50	Landscape	Safety shower	1 / Pack
815781	297	74	Landscape	Safety shower	1 / Pack
815782	297	105	Landscape	Safety shower	1 / Pack
815783	450	150	Landscape	Safety shower	1 / Pack
815784	600	200	Landscape	Safety shower	1 / Pack
815777	148	210	Portrait	Safety shower	1 / Pack
815778	210	297	Portrait	Safety shower	1 / Pack
815779	297	420	Portrait	Safety shower	1 / Pack
Polypropylene					
815788	150	50	Landscape	Safety shower	1 / Pack
815789	297	74	Landscape	Safety shower	1 / Pack
815790	297	105	Landscape	Safety shower	1 / Pack
815791	450	150	Landscape	Safety shower	1 / Pack
815792	600	200	Landscape	Safety shower	1 / Pack
815785	148	210	Portrait	Safety shower	1 / Pack
815786	210	297	Portrait	Safety shower	1 / Pack
815787	297	420	Portrait	Safety shower	1 / Pack
Aluminium					
815796	150	50	Landscape	Safety shower	1 / Pack
815797	297	105	Landscape	Safety shower	1 / Pack
815798	450	150	Landscape	Safety shower	1 / Pack
815793	148	210	Portrait	Safety shower	1 / Pack
815794	210	297	Portrait	Safety shower	1 / Pack
815795	297	420	Portrait	Safety shower	1 / Pack

BRADY
Customise-it

See page 196 to order your custom-made signs.



For all material properties and applications, see pages 4-5



E013 : STRETCHER

Clearly indicate where a stretcher is being stored to ensure that if an employee is injured or not feeling well, they can easily be moved to a suitable place, in order to receive the necessary care.



SIGNS

Order Ref.	Width (mm)	Height (mm)	Total Qty/ Pack
Laminated Polyester			
815867	100	100	1 / Pack
815868	148	148	1 / Pack
815869	200	200	1 / Pack
815870	250	250	1 / Pack
815872	315	315	1 / Pack
815873	400	400	1 / Pack
Polypropylene			
815875	100	100	1 / Pack
815876	148	148	1 / Pack
815877	200	200	1 / Pack
815878	250	250	1 / Pack
815880	315	315	1 / Pack
815881	400	400	1 / Pack
Aluminium			
815882	100	100	1 / Pack
815883	200	200	1 / Pack

FLOOR MARKING

Order Ref.	Width (mm)	Height (mm)	Total Qty/ Pack
Anti-skid Laminated Polyester			
815874	500	500	1 / Pack

MINI-PICTOGRAMS

Order Ref.	Width (mm)	Height (mm)	Total Qty/ Pack
Vinyl			
815865	10	10	96 / Pack



PHOTOLUMINESCENT SIGNS

Order Ref.	Width (mm)	Height (mm)	Class	Total Qty/ Pack
Class B Photoluminescent Polyester				
836577	150	150	Class B	1 / Pack
836579	200	200	Class B	1 / Pack
Class C Photoluminescent Polyester				
834612	150	150	Class C	1 / Pack
834613	200	200	Class C	1 / Pack
Class B Photoluminescent Polypropylene				
836572	150	150	Class B	1 / Pack
836575	200	200	Class B	1 / Pack
836576	300	300	Class B	1 / Pack
Class C Photoluminescent Aluminium				
834610	150	150	Class C	1 / Pack
834611	200	200	Class C	1 / Pack



PICTOGRAMS ON ROLLS

Order Ref.	Width (mm)	Height (mm)	Total Qty/ Pack
Laminated Polyester			
815866	100	100	250 / Roll

BI-DIRECTIONAL SIGNS



Bi-directional

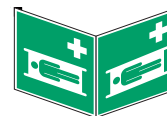

Panoramic

Order Ref.	Width (mm)	Height (mm)	Layout	Total Qty/ Pack
Polyvinylchloride				
815884	151	151	Bi-directional	1 / Pack
815885	203	203	Bi-directional	1 / Pack
815886	253	253	Bi-directional	1 / Pack
815887	318	318	Bi-directional	1 / Pack
815888	151	151	Panoramic	1 / Pack
815889	203	203	Panoramic	1 / Pack
815890	253	253	Panoramic	1 / Pack
815891	318	318	Panoramic	1 / Pack

SIGNS WITH TEXT



Order Ref.	Width (mm)	Height (mm)	Layout	Legend	Total Qty/ Pack
Laminated Polyester					
815939	150	50	Landscape	Stretcher	1 / Pack
815940	297	74	Landscape	Stretcher	1 / Pack
815941	297	105	Landscape	Stretcher	1 / Pack
815942	450	150	Landscape	Stretcher	1 / Pack
815943	600	200	Landscape	Stretcher	1 / Pack
815936	148	210	Portrait	Stretcher	1 / Pack
815937	210	297	Portrait	Stretcher	1 / Pack
815938	297	420	Portrait	Stretcher	1 / Pack
Polypropylene					
815947	150	50	Landscape	Stretcher	1 / Pack
815948	297	74	Landscape	Stretcher	1 / Pack
815949	297	105	Landscape	Stretcher	1 / Pack
815950	450	150	Landscape	Stretcher	1 / Pack
815951	600	200	Landscape	Stretcher	1 / Pack
815944	148	210	Portrait	Stretcher	1 / Pack
815945	210	297	Portrait	Stretcher	1 / Pack
815946	297	420	Portrait	Stretcher	1 / Pack
Aluminium					
815955	150	50	Landscape	Stretcher	1 / Pack
815956	297	105	Landscape	Stretcher	1 / Pack
815957	450	150	Landscape	Stretcher	1 / Pack
815952	148	210	Portrait	Stretcher	1 / Pack
815953	210	297	Portrait	Stretcher	1 / Pack
815954	297	420	Portrait	Stretcher	1 / Pack

BRADY
Customise-it

See page 196 to order your custom-made signs.



For all material properties and applications, see pages 4-5

Complies with EN ISO 7010

E014 : CHILD SEAT PRESENCE AND ORIENTATION DETECTION SYSTEM (CPOD)

Airbags in vehicles are saving thousands of lives each year. Unfortunately they can also cause injuries, even with fatal consequences for passengers, especially for young children. A child seat presence and orientation detection system is intended to improve passenger safety by reducing the risk of an airbag being deployed against a child seat in the event of a crash.



SIGNS

Order Ref.	Width (mm)	Height (mm)	Total Qty/ Pack
Laminated Polyester			
831182	100	100	1 / Pack
831183	148	148	1 / Pack
831184	200	200	1 / Pack
Polypropylene			
831190	100	100	1 / Pack
831191	148	148	1 / Pack
831192	200	200	1 / Pack
Aluminium			
831197	100	100	1 / Pack
831198	200	200	1 / Pack

MINI-PICTOGRAMS

Order Ref.	Width (mm)	Height (mm)	Total Qty/ Pack
Vinyl			
831180	10	10	96 / Pack



PICTOGRAMS ON ROLLS

Order Ref.	Width (mm)	Height (mm)	Total Qty/Pack
Laminated Polyester			
831181	100	100	250 / Roll



PHOTOLUMINESCENT SIGNS

Order Ref.	Width (mm)	Height (mm)	Class	Total Qty/ Pack
Class B Photoluminescent Polyester				
834636	150	150	Class B	1 / Pack
Class C Photoluminescent Polyester				
834639	150	150	Class C	1 / Pack
Class B Photoluminescent Polypropylene				
834625	150	150	Class B	1 / Pack
Class C Photoluminescent Polypropylene				
834628	150	150	Class C	1 / Pack
Class C Photoluminescent Aluminium				
834615	150	150	Class C	1 / Pack

BRADY Customise-it

See page 196 to order your custom-made signs.



For all material properties and applications, see pages 4-5



See page 112 for No Smoking signs in sizes suitable for being applied in cars.



E015 : DRINKING WATER

Indicating whether water is drinkable or not, especially in a public setting, is essential to avoid any health risk.



SIGNS

Order Ref.	Width (mm)	Height (mm)	Total Qty/ Pack
Laminated Polyester			
831263	100	100	1 / Pack
831264	148	148	1 / Pack
831265	200	200	1 / Pack
831266	250	250	1 / Pack
831268	315	315	1 / Pack
831269	400	400	1 / Pack
Polypropylene			
831271	100	100	1 / Pack
831272	148	148	1 / Pack
831273	200	200	1 / Pack
831274	250	250	1 / Pack
831276	315	315	1 / Pack
831277	400	400	1 / Pack
Aluminium			
831278	100	100	1 / Pack
831279	200	200	1 / Pack

BI-DIRECTIONAL SIGNS



Bi-directional



Panoramic

Order Ref.	Width (mm)	Height (mm)	Layout	Total Qty/ Pack
Polyvinylchloride				
831280	151	151	Bi-directional	1 / Pack
831281	203	203	Bi-directional	1 / Pack
831282	253	253	Bi-directional	1 / Pack
831283	318	318	Bi-directional	1 / Pack
831284	151	151	Panoramic	1 / Pack
831285	203	203	Panoramic	1 / Pack
831286	253	253	Panoramic	1 / Pack
831287	318	318	Panoramic	1 / Pack

FLOOR MARKING

Order Ref.	Width (mm)	Height (mm)	Total Qty/ Pack
Anti-skid Laminated Polyester			
831270	500	500	1 / Pack

MINI-PICTOGRAMS

Order Ref.	Width (mm)	Height (mm)	Total Qty/ Pack
Vinyl			
831261	10	10	96 / Pack

BRADY
Customise-it

See page 196 to order your custom-made signs.



For all material properties and applications, see pages 4-5



PICTOGRAMS ON ROLLS

Order Ref.	Width (mm)	Height (mm)	Total Qty/ Pack
Laminated Polyester			
831262	100	100	250 / Roll

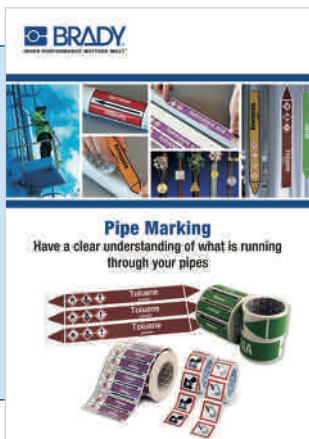

Correct identification of pipes guarantees a better overview of a building's structure. Accidents, injuries and damage can be avoided. Contact your Brady distributor to find out more about our full range of pipe markers.

Complies with EN ISO 7010

E016 : EMERGENCY WINDOW WITH ESCAPE LADDER (LEFT)

Identifying an emergency window with a ladder indicates a fast and safe exit in the event of an emergency evacuation.



SIGNS

Order Ref.	Width (mm)	Height (mm)	Total Qty/ Pack
Laminated Polyester			
816026	100	100	1 / Pack
816027	148	148	1 / Pack
816028	200	200	1 / Pack
816029	250	250	1 / Pack
816031	315	315	1 / Pack
816032	400	400	1 / Pack
Polypropylene			
816034	100	100	1 / Pack
816035	148	148	1 / Pack
816036	200	200	1 / Pack
816037	250	250	1 / Pack
816039	315	315	1 / Pack
816040	400	400	1 / Pack
Aluminium			
816041	100	100	1 / Pack
816042	200	200	1 / Pack

FLOOR MARKING

Order Ref.	Width (mm)	Height (mm)	Total Qty/ Pack
Anti-skid Laminated Polyester			
816033	500	500	1 / Pack

MINI-PICTOGRAMS

Order Ref.	Width (mm)	Height (mm)	Total Qty/ Pack
Vinyl			
816024	10	10	96 / Pack



PHOTOLUMINESCENT SIGNS

Order Ref.	Width (mm)	Height (mm)	Class	Total Qty/ Pack
Class C Photoluminescent Polyester				
834647	150	150	Class C	1 / Pack
834648	200	200	Class C	1 / Pack
Class C Photoluminescent Aluminium				
834644	150	150	Class C	1 / Pack
834645	200	200	Class C	1 / Pack



PICTOGRAMS ON ROLLS

Order Ref.	Width (mm)	Height (mm)	Total Qty/ Pack
Laminated Polyester			
816025	100	100	250 / Roll



Bi-directional



Panoramic

BI-DIRECTIONAL SIGNS

Order Ref.	Width (mm)	Height (mm)	Layout	Total Qty/ Pack
Polyvinylchloride				
816043	151	151	Bi-directional	1 / Pack
816044	203	203	Bi-directional	1 / Pack
816045	253	253	Bi-directional	1 / Pack
816046	318	318	Bi-directional	1 / Pack
816047	151	151	Panoramic	1 / Pack
816048	203	203	Panoramic	1 / Pack
816049	253	253	Panoramic	1 / Pack
816050	318	318	Panoramic	1 / Pack

SIGNS WITH TEXT

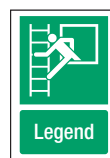

Order Ref.	Width (mm)	Height (mm)	Layout	Legend	Total Qty/ Pack
Laminated Polyester					
816098	150	50	Landscape	Emergency window with escape ladder	1 / Pack
816099	297	74	Landscape	Emergency window with escape ladder	1 / Pack
816100	297	105	Landscape	Emergency window with escape ladder	1 / Pack
816101	450	150	Landscape	Emergency window with escape ladder	1 / Pack
816102	600	200	Landscape	Emergency window with escape ladder	1 / Pack
816095	148	210	Portrait	Emergency window with escape ladder	1 / Pack
816096	210	297	Portrait	Emergency window with escape ladder	1 / Pack
816097	297	420	Portrait	Emergency window with escape ladder	1 / Pack
Polypropylene					
816106	150	50	Landscape	Emergency window with escape ladder	1 / Pack
816107	297	74	Landscape	Emergency window with escape ladder	1 / Pack
816108	297	105	Landscape	Emergency window with escape ladder	1 / Pack
816109	450	150	Landscape	Emergency window with escape ladder	1 / Pack
816110	600	200	Landscape	Emergency window with escape ladder	1 / Pack
816103	148	210	Portrait	Emergency window with escape ladder	1 / Pack
816104	210	297	Portrait	Emergency window with escape ladder	1 / Pack
816105	297	420	Portrait	Emergency window with escape ladder	1 / Pack
Aluminium					
816114	150	50	Landscape	Emergency window with escape ladder	1 / Pack
816115	297	105	Landscape	Emergency window with escape ladder	1 / Pack
816116	450	150	Landscape	Emergency window with escape ladder	1 / Pack
816111	148	210	Portrait	Emergency window with escape ladder	1 / Pack
816112	210	297	Portrait	Emergency window with escape ladder	1 / Pack
816113	297	420	Portrait	Emergency window with escape ladder	1 / Pack

BRADY
Customise-it

See page 196 to order your custom-made signs.



For all material properties and applications, see pages 4-5

E016B : EMERGENCY WINDOW WITH ESCAPE LADDER (RIGHT)

Identifying an emergency window with a ladder indicates a fast and safe exit in the event of an emergency evacuation.



PHOTOLUMINESCENT SIGNS

Order Ref.	Width (mm)	Height (mm)	Class	Total Qty/ Pack
Class C Photoluminescent Polyester				
836582	150	150	Class C	1 / Pack
836583	200	200	Class C	1 / Pack
Class C Photoluminescent Aluminium				
836580	150	150	Class C	1 / Pack
836581	200	200	Class C	1 / Pack

E016C : EMERGENCY WINDOW



PHOTOLUMINESCENT SIGNS

Order Ref.	Width (mm)	Height (mm)	Class	Total Qty/ Pack
Class C Photoluminescent Polyester				
836586	150	150	Class C	1 / Pack
836587	200	200	Class C	1 / Pack
Class C Photoluminescent Aluminium				
836584	150	150	Class C	1 / Pack
836585	200	200	Class C	1 / Pack

Complies with EN ISO 7010



E017 : RESCUE WINDOW

An emergency window is indicated by this sign on the inside for those evacuating. The fire brigade are also aware of these windows so that they are ready to evacuate any people who may be present there.



SIGNS

Order Ref.	Width (mm)	Height (mm)	Total Qty/ Pack
Laminated Polyester			
816185	100	100	1 / Pack
816186	148	148	1 / Pack
816187	200	200	1 / Pack
816188	250	250	1 / Pack
816190	315	315	1 / Pack
816191	400	400	1 / Pack
Polypropylene			
816193	100	100	1 / Pack
816194	148	148	1 / Pack
816195	200	200	1 / Pack
816196	250	250	1 / Pack
816198	315	315	1 / Pack
816199	400	400	1 / Pack
Aluminium			
816200	100	100	1 / Pack
816201	200	200	1 / Pack

FLOOR MARKING

Order Ref.	Width (mm)	Height (mm)	Total Qty/ Pack
Anti-skid Laminated Polyester			
816192	500	500	1 / Pack

MINI-PICTOGRAMS

Order Ref.	Width (mm)	Height (mm)	Total Qty/ Pack
Vinyl			
816183	10	10	96 / Pack



PHOTOLUMINESCENT SIGNS

Order Ref.	Width (mm)	Height (mm)	Class	Total Qty/ Pack
Class C Photoluminescent Polyester				
834651	150	150	Class C	1 / Pack
834652	200	200	Class C	1 / Pack
Class C Photoluminescent Aluminium				
834649	150	150	Class C	1 / Pack
834650	200	200	Class C	1 / Pack



PICTOGRAMS ON ROLLS

Order Ref.	Width (mm)	Height (mm)	Total Qty/ Pack
Laminated Polyester			
816184	100	100	250 / Roll



Bi-directional



Panoramic

BI-DIRECTIONAL SIGNS

Order Ref.	Width (mm)	Height (mm)	Layout	Total Qty/ Pack
Polyvinylchloride				
816202	151	151	Bi-directional	1 / Pack
816203	203	203	Bi-directional	1 / Pack
816204	253	253	Bi-directional	1 / Pack
816205	318	318	Bi-directional	1 / Pack
816206	151	151	Panoramic	1 / Pack
816207	203	203	Panoramic	1 / Pack
816208	253	253	Panoramic	1 / Pack
816209	318	318	Panoramic	1 / Pack

SIGNS WITH TEXT



Legend



Legend

Order Ref.	Width (mm)	Height (mm)	Layout	Legend	Total Qty/ Pack
Laminated Polyester					
816257	150	50	Landscape	Rescue window	1 / Pack
816258	297	74	Landscape	Rescue window	1 / Pack
816259	297	105	Landscape	Rescue window	1 / Pack
816260	450	150	Landscape	Rescue window	1 / Pack
816261	600	200	Landscape	Rescue window	1 / Pack
816254	148	210	Portrait	Rescue window	1 / Pack
816255	210	297	Portrait	Rescue window	1 / Pack
816256	297	420	Portrait	Rescue window	1 / Pack
Polypropylene					
816265	150	50	Landscape	Rescue window	1 / Pack
816266	297	74	Landscape	Rescue window	1 / Pack
816267	297	105	Landscape	Rescue window	1 / Pack
816268	450	150	Landscape	Rescue window	1 / Pack
816269	600	200	Landscape	Rescue window	1 / Pack
816262	148	210	Portrait	Rescue window	1 / Pack
816263	210	297	Portrait	Rescue window	1 / Pack
816264	297	420	Portrait	Rescue window	1 / Pack
Aluminium					
816273	150	50	Landscape	Rescue window	1 / Pack
816274	297	105	Landscape	Rescue window	1 / Pack
816275	450	150	Landscape	Rescue window	1 / Pack
816270	148	210	Portrait	Rescue window	1 / Pack
816271	210	297	Portrait	Rescue window	1 / Pack
816272	297	420	Portrait	Rescue window	1 / Pack

Complies with EN ISO 7010

E018 : TURN ANTICLOCKWISE TO OPEN

In the event of an evacuation, panic can quickly take over. It is therefore essential to provide any signs that may make evacuation easier, such as showing the direction of opening for a handle. For this reason, there is a clockwise opening (E019) and an anti-clockwise opening (E018) symbol.



SIGNS

Order Ref.	Width (mm)	Height (mm)	Total Qty/ Pack
Laminated Polyester			
816344	100	100	1 / Pack
816345	148	148	1 / Pack
816346	200	200	1 / Pack
816347	250	250	1 / Pack
816349	315	315	1 / Pack
816350	400	400	1 / Pack
Polypropylene			
816352	100	100	1 / Pack
816353	148	148	1 / Pack
816354	200	200	1 / Pack
816355	250	250	1 / Pack
816357	315	315	1 / Pack
816358	400	400	1 / Pack
Aluminium			
816359	100	100	1 / Pack
816360	200	200	1 / Pack

MINI-PICTOGRAMS

Order Ref.	Width (mm)	Height (mm)	Total Qty/ Pack
Vinyl			
816342	10	10	96 / Pack

SIGNS WITH TEXT



Order Ref.	Width (mm)	Height (mm)	Layout	Legend	Total Qty/ Pack
Laminated Polyester					
816416	150	50	Landscape	Turn anticlockwise to open	1 / Pack
816417	297	74	Landscape	Turn anticlockwise to open	1 / Pack
816418	297	105	Landscape	Turn anticlockwise to open	1 / Pack
816419	450	150	Landscape	Turn anticlockwise to open	1 / Pack
816420	600	200	Landscape	Turn anticlockwise to open	1 / Pack
816413	148	210	Portrait	Turn anticlockwise to open	1 / Pack
816414	210	297	Portrait	Turn anticlockwise to open	1 / Pack
816415	297	420	Portrait	Turn anticlockwise to open	1 / Pack
Polypropylene					
816424	150	50	Landscape	Turn anticlockwise to open	1 / Pack
816425	297	74	Landscape	Turn anticlockwise to open	1 / Pack
816426	297	105	Landscape	Turn anticlockwise to open	1 / Pack
816427	450	150	Landscape	Turn anticlockwise to open	1 / Pack
816428	600	200	Landscape	Turn anticlockwise to open	1 / Pack
816421	148	210	Portrait	Turn anticlockwise to open	1 / Pack
816422	210	297	Portrait	Turn anticlockwise to open	1 / Pack
816423	297	420	Portrait	Turn anticlockwise to open	1 / Pack
Aluminium					
816432	150	50	Landscape	Turn anticlockwise to open	1 / Pack
816433	297	105	Landscape	Turn anticlockwise to open	1 / Pack
816434	450	150	Landscape	Turn anticlockwise to open	1 / Pack
816429	148	210	Portrait	Turn anticlockwise to open	1 / Pack
816430	210	297	Portrait	Turn anticlockwise to open	1 / Pack
816431	297	420	Portrait	Turn anticlockwise to open	1 / Pack



PHOTOLUMINESCENT SIGNS

Order Ref.	Width (mm)	Height (mm)	Class	Total Qty/ Pack
Class C Photoluminescent Polyester				
834664	150	150	Class C	1 / Pack
834665	200	200	Class C	1 / Pack
Class C Photoluminescent Aluminium				
834661	150	150	Class C	1 / Pack
834662	200	200	Class C	1 / Pack

PHOTOLUMINESCENT SIGNS WITH TEXT



Order Ref.	Width (mm)	Height (mm)	Class	Legend	Total Qty/ Pack
Class B Photoluminescent Polypropylene					
834655	100	50	Class B	Turn to open	1 / Pack
834656	150	150	Class B	Turn to open	1 / Pack
Class B Photoluminescent Polyester					
834659	100	50	Class B	Turn to open	1 / Pack
834660	150	150	Class B	Turn to open	1 / Pack



PICTOGRAMS ON ROLLS

Order Ref.	Width (mm)	Height (mm)	Total Qty/ Pack
Laminated Polyester			
816343	100	100	250 / Roll

BRADY
Customise-it

See page 196 to order your custom-made signs.



For all material properties and applications, see pages 4-5



E019 : TURN CLOCKWISE TO OPEN

In the event of an evacuation, panic can quickly take over. It is therefore essential to provide any signs that may make evacuation easier, such as showing the direction of opening for a handle. For this reason, there is a clockwise opening (E019) and an anti-clockwise opening (E018) symbol.



SIGNS

Order Ref.	Width (mm)	Height (mm)	Total Qty/ Pack
Laminated Polyester			
816503	100	100	1 / Pack
816504	148	148	1 / Pack
816505	200	200	1 / Pack
816506	250	250	1 / Pack
816508	315	315	1 / Pack
816509	400	400	1 / Pack
Polypropylene			
816511	100	100	1 / Pack
816512	148	148	1 / Pack
816513	200	200	1 / Pack
816514	250	250	1 / Pack
816516	315	315	1 / Pack
816517	400	400	1 / Pack
Aluminium			
816518	100	100	1 / Pack
816519	200	200	1 / Pack

MINI-PICTOGRAMS

Order Ref.	Width (mm)	Height (mm)	Total Qty/ Pack
Vinyl			
816501	10	10	96 / Pack

SIGNS WITH TEXT



Order Ref.	Width (mm)	Height (mm)	Layout	Legend	Total Qty/ Pack
Laminated Polyester					
816575	150	50	Landscape	Turn clockwise to open	1 / Pack
816576	297	74	Landscape	Turn clockwise to open	1 / Pack
816577	297	105	Landscape	Turn clockwise to open	1 / Pack
816578	450	150	Landscape	Turn clockwise to open	1 / Pack
816579	600	200	Landscape	Turn clockwise to open	1 / Pack
816572	148	210	Portrait	Turn clockwise to open	1 / Pack
816573	210	297	Portrait	Turn clockwise to open	1 / Pack
816574	297	420	Portrait	Turn clockwise to open	1 / Pack
Polypropylene					
816583	150	50	Landscape	Turn clockwise to open	1 / Pack
816584	297	74	Landscape	Turn clockwise to open	1 / Pack
816585	297	105	Landscape	Turn clockwise to open	1 / Pack
816586	450	150	Landscape	Turn clockwise to open	1 / Pack
816587	600	200	Landscape	Turn clockwise to open	1 / Pack
816580	148	210	Portrait	Turn clockwise to open	1 / Pack
816581	210	297	Portrait	Turn clockwise to open	1 / Pack
816582	297	420	Portrait	Turn clockwise to open	1 / Pack
Aluminium					
816591	150	50	Landscape	Turn clockwise to open	1 / Pack
816592	297	105	Landscape	Turn clockwise to open	1 / Pack
816593	450	150	Landscape	Turn clockwise to open	1 / Pack
816588	148	210	Portrait	Turn clockwise to open	1 / Pack
816589	210	297	Portrait	Turn clockwise to open	1 / Pack
816590	297	420	Portrait	Turn clockwise to open	1 / Pack



PHOTOLUMINESCENT SIGNS

Order Ref.	Width (mm)	Height (mm)	Class	Total Qty/ Pack
Class C Photoluminescent Polyester				
834676	150	150	Class C	1 / Pack
834677	200	200	Class C	1 / Pack
Class C Photoluminescent Aluminium				
834672	150	150	Class C	1 / Pack
834675	200	200	Class C	1 / Pack

PHOTOLUMINESCENT SIGNS WITH TEXT



Order Ref.	Width (mm)	Height (mm)	Class	Legend	Total Qty/ Pack
Class B Photoluminescent Polypropylene					
834667	100	50	Class B	Turn to open	1 / Pack
834668	150	150	Class B	Turn to open	1 / Pack
Class B Photoluminescent Polyester					
834669	100	50	Class B	Turn to open	1 / Pack
834670	150	150	Class B	Turn to open	1 / Pack



PICTOGRAMS ON ROLLS

Order Ref.	Width (mm)	Height (mm)	Total Qty/ Pack
Laminated Polyester			
816502	100	100	250 / Roll

BRADY
Customise-it

See page 196 to order your custom-made signs.



For all material properties and applications, see pages 4-5

Complies with EN ISO 7010

E020 : EMERGENCY STOP BUTTON

As its name suggests, the emergency stop button must be able to be used very quickly, it must therefore be clearly indicated.



SIGNS

Order Ref.	Width (mm)	Height (mm)	Total Qty/ Pack
Laminated Polyester			
831290	100	100	1 / Pack
831291	148	148	1 / Pack
831292	200	200	1 / Pack
831293	250	250	1 / Pack
831295	315	315	1 / Pack
831296	400	400	1 / Pack
Polypropylene			
831298	100	100	1 / Pack
831299	148	148	1 / Pack
831300	200	200	1 / Pack
831301	250	250	1 / Pack
831303	315	315	1 / Pack
831304	400	400	1 / Pack
Aluminium			
831305	100	100	1 / Pack
831306	200	200	1 / Pack

FLOOR MARKING

Order Ref.	Width (mm)	Height (mm)	Total Qty/ Pack
Anti-skid Laminated Polyester			
831297	500	500	1 / Pack

MINI-PICTOGRAMS

Order Ref.	Width (mm)	Height (mm)	Total Qty/ Pack
Vinyl			
831288	10	10	96 / Pack



Bi-directional



Panoramic



BI-DIRECTIONAL SIGNS

Order Ref.	Width (mm)	Height (mm)	Layout	Total Qty/ Pack
Polyvinylchloride				
831307	151	151	Bi-directional	1 / Pack
831308	203	203	Bi-directional	1 / Pack
831309	253	253	Bi-directional	1 / Pack
831310	318	318	Bi-directional	1 / Pack
831311	151	151	Panoramic	1 / Pack
831312	203	203	Panoramic	1 / Pack
831313	253	253	Panoramic	1 / Pack
831314	318	318	Panoramic	1 / Pack

PHOTOLUMINESCENT SIGNS

Order Ref.	Width (mm)	Height (mm)	Class	Total Qty/ Pack
Class C Photoluminescent Polyester				
134672	150	150	Class C	1 / Pack
Class C Photoluminescent Aluminium				
134671	200	200	Class C	1 / Pack

PICTOGRAMS ON ROLLS

Order Ref.	Width (mm)	Height (mm)	Total Qty/ Pack
Laminated Polyester			
831289	100	100	250 / Roll

Complies with EN ISO 7010

E021 : PROTECTION SHELTER

Protection shelters must be clearly identified to ensure they can be easily found in case of an emergency.



SIGNS

Order Ref.	Width (mm)	Height (mm)	Total Qty/ Pack
Laminated Polyester			
197824	100	100	1 / Pack
197827	100	100	1 / Pack
197825	148	148	1 / Pack
197826	200	200	1 / Pack
Polypropylene			
197828	148	148	1 / Pack
197829	200	200	1 / Pack
Aluminium			
197830	100	100	1 / Pack
197831	150	150	1 / Pack
197832	200	200	1 / Pack



PHOTOLUMINESCENT SIGNS

Order Ref.	Width (mm)	Height (mm)	Class	Total Qty/ Pack
Class B Photoluminescent Polyester				
197833	100	100	Class B	1 / Pack
197834	150	150	Class B	1 / Pack
197835	200	200	Class B	1 / Pack
Class C Photoluminescent Polyester				
197836	100	100	Class C	1 / Pack
197837	150	150	Class C	1 / Pack
197838	200	200	Class C	1 / Pack
Class B Photoluminescent Polypropylene				
197839	100	100	Class B	1 / Pack
197840	150	150	Class B	1 / Pack
197841	200	200	Class B	1 / Pack
Class C Photoluminescent Polypropylene				
197842	100	100	Class C	1 / Pack
197843	150	150	Class C	1 / Pack
197844	200	200	Class C	1 / Pack
Class C Photoluminescent Aluminium				
197845	100	100	Class C	1 / Pack
197846	150	150	Class C	1 / Pack
197847	200	200	Class C	1 / Pack

BRADY
Customise-it

See page 196 to order your custom-made signs.



For all material properties and applications, see pages 4-5



E022 : DOOR OPENS BY PUSHING ON THE LEFT-HAND SIDE

In the event of an emergency evacuation, each second and each movement can make all the difference. Knowing which side of a door to push to open it can therefore save lives and avoid additional stress. There is a left-hand side (E022) and a right-hand side (E023) version of this symbol. There is also a 'pull' version for the left-hand side (E057) or the right-hand side (E058) of the door.



SIGNS

Order Ref.	Width (mm)	Height (mm)	Total Qty/Pack
Laminated Polyester			
831209	100	100	1 / Pack
831210	148	148	1 / Pack
831211	200	200	1 / Pack
831212	250	250	1 / Pack
831214	315	315	1 / Pack
831215	400	400	1 / Pack
Polypropylene			
831217	100	100	1 / Pack
831218	148	148	1 / Pack
831219	200	200	1 / Pack
831220	250	250	1 / Pack
831222	315	315	1 / Pack
831223	400	400	1 / Pack
Aluminium			
831224	100	100	1 / Pack
831225	200	200	1 / Pack

FLOOR MARKING

Order Ref.	Width (mm)	Height (mm)	Total Qty/Pack
Anti-skid Laminated Polyester			
831216	500	500	1 / Pack

MINI-PICTOGRAMS

Order Ref.	Width (mm)	Height (mm)	Total Qty/Pack
Vinyl			
831207	10	10	96 / Pack



PHOTOLUMINESCENT SIGNS

Order Ref.	Width (mm)	Height (mm)	Class	Total Qty/Pack
Class B Photoluminescent Polyester				
834689	150	150	Class B	1 / Pack
834690	200	200	Class B	1 / Pack
Class C Photoluminescent Polyester				
834692	150	150	Class C	1 / Pack
834693	200	200	Class C	1 / Pack
Class B Photoluminescent Polypropylene				
834682	150	150	Class B	1 / Pack
834683	200	200	Class B	1 / Pack
Class C Photoluminescent Polypropylene				
834687	150	150	Class C	1 / Pack
834688	200	200	Class C	1 / Pack
Class C Photoluminescent Aluminium				
834680	150	150	Class C	1 / Pack
834681	200	200	Class C	1 / Pack



PICTOGRAMS ON ROLLS

Order Ref.	Width (mm)	Height (mm)	Total Qty/Pack
Laminated Polyester			
831208	100	100	250 / Roll

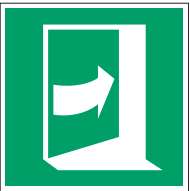

E023 : DOOR OPENS BY PUSHING ON THE RIGHT-HAND SIDE

In the event of an emergency evacuation, each second and each movement can make all the difference. Knowing which side of a door to push to open it can therefore save lives and avoid additional stress. There is a left-hand side (E022) and a right-hand side (E023) version of this symbol. There is also a 'pull' version for the left-hand side (E057) or the right-hand side (E058) of the door.



SIGNS

Order Ref.	Width (mm)	Height (mm)	Total Qty/Pack
Laminated Polyester			
831236	100	100	1 / Pack
831237	148	148	1 / Pack
831238	200	200	1 / Pack
831239	250	250	1 / Pack
831241	315	315	1 / Pack
831242	400	400	1 / Pack
Polypropylene			
831244	100	100	1 / Pack
831245	148	148	1 / Pack
831246	200	200	1 / Pack
831247	250	250	1 / Pack
831249	315	315	1 / Pack
831250	400	400	1 / Pack
Aluminium			
831251	100	100	1 / Pack
831252	200	200	1 / Pack

FLOOR MARKING

Order Ref.	Width (mm)	Height (mm)	Total Qty/Pack
Anti-skid Laminated Polyester			
831243	500	500	1 / Pack

MINI-PICTOGRAMS

Order Ref.	Width (mm)	Height (mm)	Total Qty/Pack
Vinyl			
831234	10	10	96 / Pack



PICTOGRAMS ON ROLLS

Order Ref.	Width (mm)	Height (mm)	Total Qty/Pack
Laminated Polyester			
831235	100	100	250 / Roll



PHOTOLUMINESCENT SIGNS

Order Ref.	Width (mm)	Height (mm)	Class	Total Qty/Pack
Class B Photoluminescent Polyester				
834702	150	150	Class B	1 / Pack
834703	200	200	Class B	1 / Pack
Class C Photoluminescent Polyester				
834704	150	150	Class C	1 / Pack
834705	200	200	Class C	1 / Pack
Class B Photoluminescent Polypropylene				
834696	150	150	Class B	1 / Pack
834697	200	200	Class B	1 / Pack
Class C Photoluminescent Polypropylene				
834698	150	150	Class C	1 / Pack
834701	200	200	Class C	1 / Pack
Class C Photoluminescent Aluminium				
834694	150	150	Class C	1 / Pack
834695	200	200	Class C	1 / Pack

Complies with EN ISO 7010

E024 : EVACUATION TEMPORARY REFUGE

In the event of an evacuation, people with reduced mobility are asked to go to a previously designated temporary refuge point, indicated by this symbol. In this way, they can be helped by designated people.



SIGNS

Order Ref.	Width (mm)	Height (mm)	Total Qty/Pack
Laminated Polyester			
134825	100	100	1 / Pack
134826	148	148	1 / Pack
134827	200	200	1 / Pack
Polypropylene			
134819	100	100	1 / Pack
134820	148	148	1 / Pack
134821	200	200	1 / Pack
Aluminium			
134822	100	100	1 / Pack
134823	150	150	1 / Pack
134824	200	200	1 / Pack



PHOTOLUMINESCENT SIGNS

Order Ref.	Width (mm)	Height (mm)	Class	Total Qty/Pack
Class B Photoluminescent Polyester				
134834	100	100	Class B	1 / Pack
134835	150	150	Class B	1 / Pack
134836	200	200	Class B	1 / Pack
Class C Photoluminescent Polyester				
134843	100	100	Class C	1 / Pack
134844	150	150	Class C	1 / Pack
134845	200	200	Class C	1 / Pack
Class B Photoluminescent Polypropylene				
134828	100	100	Class B	1 / Pack
134829	150	150	Class B	1 / Pack
134830	200	200	Class B	1 / Pack
Class C Photoluminescent Polypropylene				
134837	100	100	Class C	1 / Pack
134838	150	150	Class C	1 / Pack
134839	200	200	Class C	1 / Pack
Class C Photoluminescent Aluminium				
134840	100	100	Class C	1 / Pack
134841	150	150	Class C	1 / Pack
134842	200	200	Class C	1 / Pack

Complies with EN ISO 7010

E025 : EMERGENCY HAMMER

Clearly indicate the location of an emergency hammer to facilitate evacuation.



SIGNS

Order Ref.	Width (mm)	Height (mm)	Total Qty/Pack
Laminated Polyester			
197229	100	100	1 / Pack
197230	148	148	1 / Pack
197231	200	200	1 / Pack
197232	250	250	1 / Pack
197233	315	315	1 / Pack
197234	400	400	1 / Pack
Polypropylene			
197235	148	148	1 / Pack
197236	200	200	1 / Pack
197237	250	250	1 / Pack
197238	315	315	1 / Pack
197239	400	400	1 / Pack
Aluminium			
197240	100	100	1 / Pack
197241	200	200	1 / Pack

FLOOR MARKING

Order Ref.	Width (mm)	Height (mm)	Total Qty/Pack
Anti-skid Laminated Polyester			
197278	500	500	1 / Pack

MINI-PICTOGRAMS

Order Ref.	Width (mm)	Height (mm)	Total Qty/Pack
Laminated Polyester			
197276	18	18	40 / Pack
Vinyl			
197275	10	10	96 / Pack



SIGNS WITH TEXT

Order Ref.	Width (mm)	Height (mm)	Layout	Legend	Total Qty/Pack
Laminated Polyester					
197242	150	50	Landscape	Emergency hammer	1 / Pack
197243	297	74	Landscape	Emergency hammer	1 / Pack
197244	297	105	Landscape	Emergency hammer	1 / Pack
197245	450	150	Landscape	Emergency hammer	1 / Pack
197246	600	200	Landscape	Emergency hammer	1 / Pack
197247	148	210	Portrait	Emergency hammer	1 / Pack
197248	210	297	Portrait	Emergency hammer	1 / Pack
197249	297	420	Portrait	Emergency hammer	1 / Pack
Polypropylene					
197250	150	50	Landscape	Emergency hammer	1 / Pack
197251	297	74	Landscape	Emergency hammer	1 / Pack
197252	297	105	Landscape	Emergency hammer	1 / Pack
197253	450	150	Landscape	Emergency hammer	1 / Pack
197254	600	200	Landscape	Emergency hammer	1 / Pack
197255	148	210	Portrait	Emergency hammer	1 / Pack
197256	210	297	Portrait	Emergency hammer	1 / Pack
197257	297	420	Portrait	Emergency hammer	1 / Pack
Aluminium					
197258	150	50	Landscape	Emergency hammer	1 / Pack
197259	297	105	Landscape	Emergency hammer	1 / Pack
197260	450	150	Landscape	Emergency hammer	1 / Pack
197597	600	200	Landscape	Emergency hammer	1 / Pack
197261	148	210	Portrait	Emergency hammer	1 / Pack
197262	210	297	Portrait	Emergency hammer	1 / Pack
197263	297	420	Portrait	Emergency hammer	1 / Pack



PICTOGRAMS ON ROLLS

Order Ref.	Width (mm)	Height (mm)	Total Qty/Pack
Laminated Polyester			
197277	100	100	250 / Pack



PHOTOLUMINESCENT SIGNS

Order Ref.	Width (mm)	Height (mm)	Class	Total Qty/Pack
Class B Photoluminescent Polyester				
197264	150	150	Class B	1 / Pack
197265	200	200	Class B	1 / Pack
Class C Photoluminescent Polyester				
197266	150	150	Class C	1 / Pack
197267	200	200	Class C	1 / Pack
Class B Photoluminescent Polypropylene				
197268	150	150	Class B	1 / Pack
197269	200	200	Class B	1 / Pack
197270	300	300	Class B	1 / Pack
Class C Photoluminescent Polypropylene				
197271	150	150	Class C	1 / Pack
197272	200	200	Class C	1 / Pack
Class C Photoluminescent Aluminium				
197273	150	150	Class C	1 / Pack
197274	200	200	Class C	1 / Pack



E027 : MEDICAL GRAB BAG

The emergency medical bag allows the equipment needed for an emergency intervention to be quickly found, with or without the presence of first aiders.



SIGNS

Order Ref.	Width (mm)	Height (mm)	Total Qty/ Pack
Laminated Polyester			
134852	100	100	1 / Pack
134853	148	148	1 / Pack
134854	200	200	1 / Pack
Polypropylene			
134846	100	100	1 / Pack
134847	148	148	1 / Pack
134848	200	200	1 / Pack
Aluminium			
134849	100	100	1 / Pack
134850	150	150	1 / Pack
134851	200	200	1 / Pack



PHOTOLUMINESCENT SIGNS

Order Ref.	Width (mm)	Height (mm)	Class	Total Qty/ Pack
Class B Photoluminescent Polyester				
134861	100	100	Class B	1 / Pack
134862	150	150	Class B	1 / Pack
134863	200	200	Class B	1 / Pack
Class C Photoluminescent Polyester				
134870	100	100	Class C	1 / Pack
134871	150	150	Class C	1 / Pack
134872	200	200	Class C	1 / Pack
Class B Photoluminescent Polypropylene				
134855	100	100	Class B	1 / Pack
134856	150	150	Class B	1 / Pack
134857	200	200	Class B	1 / Pack
Class C Photoluminescent Polypropylene				
134864	100	100	Class C	1 / Pack
134865	150	150	Class C	1 / Pack
134866	200	200	Class C	1 / Pack
Class C Photoluminescent Aluminium				
134867	100	100	Class C	1 / Pack
134868	150	150	Class C	1 / Pack
134869	200	200	Class C	1 / Pack



E028 : OXYGEN RESUSCITATOR

Make sure an oxygen resuscitator can be easily found in case of an emergency by clearly marking its location.



SIGNS

Order Ref.	Width (mm)	Height (mm)	Total Qty/ Pack
Laminated Polyester			
134879	100	100	1 / Pack
134880	148	148	1 / Pack
134881	200	200	1 / Pack
Polypropylene			
134873	100	100	1 / Pack
134874	148	148	1 / Pack
134875	200	200	1 / Pack
Aluminium			
134876	100	100	1 / Pack
134877	150	150	1 / Pack
134878	200	200	1 / Pack



PHOTOLUMINESCENT SIGNS

Order Ref.	Width (mm)	Height (mm)	Class	Total Qty/ Pack
Class B Photoluminescent Polyester				
134888	100	100	Class B	1 / Pack
134889	150	150	Class B	1 / Pack
134890	200	200	Class B	1 / Pack
Class C Photoluminescent Polyester				
134897	100	100	Class C	1 / Pack
134898	150	150	Class C	1 / Pack
134899	200	200	Class C	1 / Pack
Class B Photoluminescent Polypropylene				
134882	100	100	Class B	1 / Pack
134883	150	150	Class B	1 / Pack
134884	200	200	Class B	1 / Pack
Class C Photoluminescent Polypropylene				
134891	100	100	Class C	1 / Pack
134892	150	150	Class C	1 / Pack
134893	200	200	Class C	1 / Pack
Class C Photoluminescent Aluminium				
134894	100	100	Class C	1 / Pack
134895	150	150	Class C	1 / Pack
134896	200	200	Class C	1 / Pack

BRADY
Customise-it

See page 196 to order your custom-made signs.

i For all material properties and applications, see pages 4-5

Complies with EN ISO 7010

E029 : EMERGENCY ESCAPE BREATHING DEVICE



SIGNS

Order Ref.	Width (mm)	Height (mm)	Total Qty/ Pack
Laminated Polyester			
134906	100	100	1 / Pack
134907	148	148	1 / Pack
134908	200	200	1 / Pack
Polypropylene			
134900	100	100	1 / Pack
134901	148	148	1 / Pack
134902	200	200	1 / Pack
Aluminium			
134903	100	100	1 / Pack
134904	150	150	1 / Pack
134905	200	200	1 / Pack



PHOTOLUMINESCENT SIGNS

Order Ref.	Width (mm)	Height (mm)	Class	Total Qty/ Pack
Class B Photoluminescent Polyester				
134915	100	100	Class B	1 / Pack
134916	150	150	Class B	1 / Pack
134917	200	200	Class B	1 / Pack
Class C Photoluminescent Polyester				
134924	100	100	Class C	1 / Pack
134925	150	150	Class C	1 / Pack
134926	200	200	Class C	1 / Pack
Class B Photoluminescent Polypropylene				
134909	100	100	Class B	1 / Pack
134910	150	150	Class B	1 / Pack
134911	200	200	Class B	1 / Pack
Class C Photoluminescent Polypropylene				
134918	100	100	Class C	1 / Pack
134919	150	150	Class C	1 / Pack
134920	200	200	Class C	1 / Pack
Class C Photoluminescent Aluminium				
134921	100	100	Class C	1 / Pack
134922	150	150	Class C	1 / Pack
134923	200	200	Class C	1 / Pack

Complies with EN ISO 7010

E031 : SHIPBOARD GENERAL ALARM



PHOTOLUMINESCENT SIGNS

Order Ref.	Width (mm)	Height (mm)	Class	Total Qty/ Pack
Class B Photoluminescent Polyester				
134931	150	150	Class B	1 / Pack
134932	200	200	Class B	1 / Pack
Class C Photoluminescent Polyester				
134937	150	150	Class C	1 / Pack
134938	200	200	Class C	1 / Pack
Class B Photoluminescent Polypropylene				
134927	150	150	Class B	1 / Pack
134928	200	200	Class B	1 / Pack
Class C Photoluminescent Polypropylene				
134933	150	150	Class C	1 / Pack
134934	200	200	Class C	1 / Pack
Class C Photoluminescent Aluminium				
134935	150	150	Class C	1 / Pack
134936	200	200	Class C	1 / Pack

Complies with EN ISO 7010

E032 : SHIPBOARD ASSEMBLY STATION



PHOTOLUMINESCENT SIGNS

Order Ref.	Width (mm)	Height (mm)	Class	Total Qty/ Pack
Class B Photoluminescent Polyester				
134943	150	150	Class B	1 / Pack
134944	200	200	Class B	1 / Pack
Class C Photoluminescent Polyester				
134949	150	150	Class C	1 / Pack
134950	200	200	Class C	1 / Pack
Class B Photoluminescent Polypropylene				
134939	150	150	Class B	1 / Pack
134940	200	200	Class B	1 / Pack
Class C Photoluminescent Polypropylene				
134945	150	150	Class C	1 / Pack
134946	200	200	Class C	1 / Pack
Class C Photoluminescent Aluminium				
134947	150	150	Class C	1 / Pack
134948	200	200	Class C	1 / Pack

BRADY
Customise-it

See page 196 to order your custom-made signs.

i For all material properties and applications, see pages 4-5

Complies with EN ISO 7010

E033 : DOOR SLIDES RIGHT TO OPEN



PHOTOLUMINESCENT SIGNS

Order Ref.	Width (mm)	Height (mm)	Class	Total Qty/ Pack
Class B Photoluminescent Polyester				
134955	150	150	Class B	1 / Pack
134956	200	200	Class B	1 / Pack
Class C Photoluminescent Polyester				
134961	150	150	Class C	1 / Pack
134962	200	200	Class C	1 / Pack
Class B Photoluminescent Polypropylene				
134951	150	150	Class B	1 / Pack
134952	200	200	Class B	1 / Pack
Class C Photoluminescent Polypropylene				
134957	150	150	Class C	1 / Pack
134958	200	200	Class C	1 / Pack
Class C Photoluminescent Aluminium				
134959	150	150	Class C	1 / Pack
134960	200	200	Class C	1 / Pack

Complies with EN ISO 7010

E034 : DOOR SLIDES LEFT TO OPEN



PHOTOLUMINESCENT SIGNS

Order Ref.	Width (mm)	Height (mm)	Class	Total Qty/ Pack
Class B Photoluminescent Polyester				
134967	150	150	Class B	1 / Pack
134968	200	200	Class B	1 / Pack
Class C Photoluminescent Polyester				
134973	150	150	Class C	1 / Pack
134974	200	200	Class C	1 / Pack
Class B Photoluminescent Polypropylene				
134963	150	150	Class B	1 / Pack
134964	200	200	Class B	1 / Pack
Class C Photoluminescent Polypropylene				
134969	150	150	Class C	1 / Pack
134970	200	200	Class C	1 / Pack
Class C Photoluminescent Aluminium				
134971	150	150	Class C	1 / Pack
134972	200	200	Class C	1 / Pack

Complies with EN ISO 7010

E035 : LIFERAFT KNIFE



PHOTOLUMINESCENT SIGNS

Order Ref.	Width (mm)	Height (mm)	Class	Total Qty/ Pack
Class B Photoluminescent Polyester				
134979	150	150	Class B	1 / Pack
134980	200	200	Class B	1 / Pack
Class C Photoluminescent Polyester				
134985	150	150	Class C	1 / Pack
134986	200	200	Class C	1 / Pack
Class B Photoluminescent Polypropylene				
134975	150	150	Class B	1 / Pack
134976	200	200	Class B	1 / Pack
Class C Photoluminescent Polypropylene				
134981	150	150	Class C	1 / Pack
134982	200	200	Class C	1 / Pack
Class C Photoluminescent Aluminium				
134983	150	150	Class C	1 / Pack
134984	200	200	Class C	1 / Pack

Complies with EN ISO 7010

E036 : LIFEBOAT



PHOTOLUMINESCENT SIGNS

Order Ref.	Width (mm)	Height (mm)	Class	Total Qty/ Pack
Class B Photoluminescent Polyester				
134991	150	150	Class B	1 / Pack
134992	200	200	Class B	1 / Pack
Class C Photoluminescent Polyester				
134997	150	150	Class C	1 / Pack
134998	200	200	Class C	1 / Pack
Class B Photoluminescent Polypropylene				
134987	150	150	Class B	1 / Pack
134988	200	200	Class B	1 / Pack
Class C Photoluminescent Polypropylene				
134993	150	150	Class C	1 / Pack
134994	200	200	Class C	1 / Pack
Class C Photoluminescent Aluminium				
134995	150	150	Class C	1 / Pack
134996	200	200	Class C	1 / Pack

BRADY
Customise-it

See page 196 to order your custom-made signs.



For all material properties and applications, see pages 4-5

Complies with EN ISO 7010

E037 : RESCUE BOAT



PHOTOLUMINESCENT SIGNS

Order Ref.	Width (mm)	Height (mm)	Class	Total Qty/ Pack
Class B Photoluminescent Polyester				
135003	150	150	Class B	1 / Pack
135004	200	200	Class B	1 / Pack
Class C Photoluminescent Polyester				
135009	150	150	Class C	1 / Pack
135010	200	200	Class C	1 / Pack
Class B Photoluminescent Polypropylene				
134999	150	150	Class B	1 / Pack
135000	200	200	Class B	1 / Pack
Class C Photoluminescent Polypropylene				
135005	150	150	Class C	1 / Pack
135006	200	200	Class C	1 / Pack
Class C Photoluminescent Aluminium				
135007	150	150	Class C	1 / Pack
135008	200	200	Class C	1 / Pack

Complies with EN ISO 7010

E038 : LIFERAFT



PHOTOLUMINESCENT SIGNS

Order Ref.	Width (mm)	Height (mm)	Class	Total Qty/ Pack
Class B Photoluminescent Polyester				
135015	150	150	Class B	1 / Pack
135016	200	200	Class B	1 / Pack
Class C Photoluminescent Polyester				
135021	150	150	Class C	1 / Pack
135022	200	200	Class C	1 / Pack
Class B Photoluminescent Polypropylene				
135011	150	150	Class B	1 / Pack
135012	200	200	Class B	1 / Pack
Class C Photoluminescent Polypropylene				
135017	150	150	Class C	1 / Pack
135018	200	200	Class C	1 / Pack
Class C Photoluminescent Aluminium				
135019	150	150	Class C	1 / Pack
135020	200	200	Class C	1 / Pack

Complies with EN ISO 7010

E039 : DAVIT-LAUNCHED LIFERAFT



PHOTOLUMINESCENT SIGNS

Order Ref.	Width (mm)	Height (mm)	Class	Total Qty/ Pack
Class B Photoluminescent Polyester				
135027	150	150	Class B	1 / Pack
135028	200	200	Class B	1 / Pack
Class C Photoluminescent Polyester				
135033	150	150	Class C	1 / Pack
135034	200	200	Class C	1 / Pack
Class B Photoluminescent Polypropylene				
135023	150	150	Class B	1 / Pack
135024	200	200	Class B	1 / Pack
Class C Photoluminescent Polypropylene				
135029	150	150	Class C	1 / Pack
135030	200	200	Class C	1 / Pack
Class C Photoluminescent Aluminium				
135031	150	150	Class C	1 / Pack
135032	200	200	Class C	1 / Pack

Complies with EN ISO 7010

E040 : LIFEBOUY



PHOTOLUMINESCENT SIGNS

Order Ref.	Width (mm)	Height (mm)	Class	Total Qty/ Pack
Class B Photoluminescent Polyester				
135042	150	150	Class B	1 / Pack
135043	200	200	Class B	1 / Pack
Class C Photoluminescent Polyester				
135049	150	150	Class C	1 / Pack
135050	200	200	Class C	1 / Pack
Class B Photoluminescent Polypropylene				
135035	150	150	Class B	1 / Pack
135036	200	200	Class B	1 / Pack
Class C Photoluminescent Polypropylene				
135044	150	150	Class C	1 / Pack
135045	200	200	Class C	1 / Pack
Class C Photoluminescent Aluminium				
135046	150	150	Class C	1 / Pack
135047	200	200	Class C	1 / Pack

BRADY
Customise-it

See page 196 to order your custom-made signs.



For all material properties and applications, see pages 4-5

Complies with EN ISO 7010

E041 : LIFEBOUY WITH LINE



PHOTOLUMINESCENT SIGNS

Order Ref.	Width (mm)	Height (mm)	Class	Total Qty/ Pack
Class B Photoluminescent Polyester				
135056	150	150	Class B	1 / Pack
135057	200	200	Class B	1 / Pack
Class C Photoluminescent Polyester				
135063	150	150	Class C	1 / Pack
135065	200	200	Class C	1 / Pack
Class B Photoluminescent Polypropylene				
135051	150	150	Class B	1 / Pack
135052	200	200	Class B	1 / Pack
Class C Photoluminescent Polypropylene				
135058	150	150	Class C	1 / Pack
135059	200	200	Class C	1 / Pack
Class C Photoluminescent Aluminium				
135061	150	150	Class C	1 / Pack
135062	200	200	Class C	1 / Pack

Complies with EN ISO 7010

E042 : LIFEBOUY WITH LIGHT

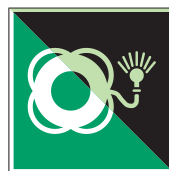

PHOTOLUMINESCENT SIGNS

Order Ref.	Width (mm)	Height (mm)	Class	Total Qty/ Pack
Class B Photoluminescent Polyester				
135070	150	150	Class B	1 / Pack
135071	200	200	Class B	1 / Pack
Class C Photoluminescent Polyester				
135077	150	150	Class C	1 / Pack
135078	200	200	Class C	1 / Pack
Class B Photoluminescent Polypropylene				
135066	150	150	Class B	1 / Pack
135067	200	200	Class B	1 / Pack
Class C Photoluminescent Polypropylene				
135073	150	150	Class C	1 / Pack
135074	200	200	Class C	1 / Pack
Class C Photoluminescent Aluminium				
135075	150	150	Class C	1 / Pack
135076	200	200	Class C	1 / Pack

Complies with EN ISO 7010

E043 : LIFEBOUY WITH LINE AND LIGHT



PHOTOLUMINESCENT SIGNS

Order Ref.	Width (mm)	Height (mm)	Class	Total Qty/ Pack
Class B Photoluminescent Polyester				
135083	150	150	Class B	1 / Pack
135084	200	200	Class B	1 / Pack
Class C Photoluminescent Polyester				
135089	150	150	Class C	1 / Pack
135090	200	200	Class C	1 / Pack
Class B Photoluminescent Polypropylene				
135079	150	150	Class B	1 / Pack
135080	200	200	Class B	1 / Pack
Class C Photoluminescent Polypropylene				
135085	150	150	Class C	1 / Pack
135086	200	200	Class C	1 / Pack
Class C Photoluminescent Aluminium				
135087	150	150	Class C	1 / Pack
135088	200	200	Class C	1 / Pack

Complies with EN ISO 7010

E044 : LIFEJACKET



PHOTOLUMINESCENT SIGNS

Order Ref.	Width (mm)	Height (mm)	Class	Total Qty/ Pack
Class B Photoluminescent Polyester				
135095	150	150	Class B	1 / Pack
135097	200	200	Class B	1 / Pack
Class C Photoluminescent Polyester				
135108	150	150	Class C	1 / Pack
135109	200	200	Class C	1 / Pack
Class B Photoluminescent Polypropylene				
135091	150	150	Class B	1 / Pack
135092	200	200	Class B	1 / Pack
Class C Photoluminescent Polypropylene				
135098	150	150	Class C	1 / Pack
135105	200	200	Class C	1 / Pack
Class C Photoluminescent Aluminium				
135106	150	150	Class C	1 / Pack
135107	200	200	Class C	1 / Pack

BRADY
Customise-it

See page 196 to order your custom-made signs.



For all material properties and applications, see pages 4-5

Complies with EN ISO 7010

E045 : CHILD'S LIFEJACKET



PHOTOLUMINESCENT SIGNS

Order Ref.	Width (mm)	Height (mm)	Class	Total Qty/ Pack
Class B Photoluminescent Polyester				
135115	150	150	Class B	1 / Pack
135116	200	200	Class B	1 / Pack
Class C Photoluminescent Polyester				
135127	150	150	Class C	1 / Pack
135129	200	200	Class C	1 / Pack
Class B Photoluminescent Polypropylene				
135110	150	150	Class B	1 / Pack
135111	200	200	Class B	1 / Pack
Class C Photoluminescent Polypropylene				
135117	150	150	Class C	1 / Pack
135118	200	200	Class C	1 / Pack
Class C Photoluminescent Aluminium				
135119	150	150	Class C	1 / Pack
135120	200	200	Class C	1 / Pack

Complies with EN ISO 7010

E046 : INFANT'S LIFEJACKET



PHOTOLUMINESCENT SIGNS

Order Ref.	Width (mm)	Height (mm)	Class	Total Qty/ Pack
Class B Photoluminescent Polyester				
135135	150	150	Class B	1 / Pack
135136	200	200	Class B	1 / Pack
Class C Photoluminescent Polyester				
135141	150	150	Class C	1 / Pack
135143	200	200	Class C	1 / Pack
Class B Photoluminescent Polypropylene				
135130	150	150	Class B	1 / Pack
135132	200	200	Class B	1 / Pack
Class C Photoluminescent Polypropylene				
135137	150	150	Class C	1 / Pack
135138	200	200	Class C	1 / Pack
Class C Photoluminescent Aluminium				
135139	150	150	Class C	1 / Pack
135140	200	200	Class C	1 / Pack

Complies with EN ISO 7010

E047 : SEARCH AND RESCUE TRANSPONDER



PHOTOLUMINESCENT SIGNS

Order Ref.	Width (mm)	Height (mm)	Class	Total Qty/ Pack
Class B Photoluminescent Polyester				
135148	150	150	Class B	1 / Pack
135149	200	200	Class B	1 / Pack
Class C Photoluminescent Polyester				
135154	150	150	Class C	1 / Pack
135155	200	200	Class C	1 / Pack
Class B Photoluminescent Polypropylene				
135144	150	150	Class B	1 / Pack
135145	200	200	Class B	1 / Pack
Class C Photoluminescent Polypropylene				
135150	150	150	Class C	1 / Pack
135151	200	200	Class C	1 / Pack
Class C Photoluminescent Aluminium				
135152	150	150	Class C	1 / Pack
135153	200	200	Class C	1 / Pack

Complies with EN ISO 7010

E048 : SURVIVAL CRAFT DISTRESS SIGNAL



PHOTOLUMINESCENT SIGNS

Order Ref.	Width (mm)	Height (mm)	Class	Total Qty/ Pack
Class B Photoluminescent Polyester				
135160	150	150	Class B	1 / Pack
135161	200	200	Class B	1 / Pack
Class C Photoluminescent Polyester				
135166	150	150	Class C	1 / Pack
135167	200	200	Class C	1 / Pack
Class B Photoluminescent Polypropylene				
135156	150	150	Class B	1 / Pack
135157	200	200	Class B	1 / Pack
Class C Photoluminescent Polypropylene				
135162	150	150	Class C	1 / Pack
135163	200	200	Class C	1 / Pack
Class C Photoluminescent Aluminium				
135164	150	150	Class C	1 / Pack
135165	200	200	Class C	1 / Pack

BRADY
Customise-it

See page 196 to order your custom-made signs.

i For all material properties and applications, see pages 4-5

Complies with EN ISO 7010

E049 : ROCKET PARACHUTE FLARE



PHOTOLUMINESCENT SIGNS

Order Ref.	Width (mm)	Height (mm)	Class	Total Qty/ Pack
Class B Photoluminescent Polyester				
135172	150	150	Class B	1 / Pack
135173	200	200	Class B	1 / Pack
Class C Photoluminescent Polyester				
135178	150	150	Class C	1 / Pack
135179	200	200	Class C	1 / Pack
Class B Photoluminescent Polypropylene				
135168	150	150	Class B	1 / Pack
135169	200	200	Class B	1 / Pack
Class C Photoluminescent Polypropylene				
135174	150	150	Class C	1 / Pack
135175	200	200	Class C	1 / Pack
Class C Photoluminescent Aluminium				
135176	150	150	Class C	1 / Pack
135177	200	200	Class C	1 / Pack

Complies with EN ISO 7010

E050 : LINE-THROWING APPLIANCE



PHOTOLUMINESCENT SIGNS

Order Ref.	Width (mm)	Height (mm)	Class	Total Qty/ Pack
Class B Photoluminescent Polyester				
135184	150	150	Class B	1 / Pack
135185	200	200	Class B	1 / Pack
Class C Photoluminescent Polyester				
135190	150	150	Class C	1 / Pack
135191	200	200	Class C	1 / Pack
Class B Photoluminescent Polypropylene				
135180	150	150	Class B	1 / Pack
135181	200	200	Class B	1 / Pack
Class C Photoluminescent Polypropylene				
135186	150	150	Class C	1 / Pack
135187	200	200	Class C	1 / Pack
Class C Photoluminescent Aluminium				
135188	150	150	Class C	1 / Pack
135189	200	200	Class C	1 / Pack

Complies with EN ISO 7010

E051 : Two-way VHF RADIOTELEPHONE APPARATUS



PHOTOLUMINESCENT SIGNS

Order Ref.	Width (mm)	Height (mm)	Class	Total Qty/ Pack
Class B Photoluminescent Polyester				
135196	150	150	Class B	1 / Pack
135197	200	200	Class B	1 / Pack
Class C Photoluminescent Polyester				
135202	150	150	Class C	1 / Pack
135205	200	200	Class C	1 / Pack
Class B Photoluminescent Polypropylene				
135192	150	150	Class B	1 / Pack
135193	200	200	Class B	1 / Pack
Class C Photoluminescent Polypropylene				
135198	150	150	Class C	1 / Pack
135199	200	200	Class C	1 / Pack
Class C Photoluminescent Aluminium				
135200	150	150	Class C	1 / Pack
135201	200	200	Class C	1 / Pack

Complies with EN ISO 7010

E052 : EMERGENCY POSITION INDICATING RADIO BEACON



PHOTOLUMINESCENT SIGNS

Order Ref.	Width (mm)	Height (mm)	Class	Total Qty/ Pack
Class B Photoluminescent Polyester				
135214	150	150	Class B	1 / Pack
135215	200	200	Class B	1 / Pack
Class C Photoluminescent Polyester				
135220	150	150	Class C	1 / Pack
135221	200	200	Class C	1 / Pack
Class B Photoluminescent Polypropylene				
135210	150	150	Class B	1 / Pack
135211	200	200	Class B	1 / Pack
Class C Photoluminescent Polypropylene				
135216	150	150	Class C	1 / Pack
135217	200	200	Class C	1 / Pack
Class C Photoluminescent Aluminium				
135218	150	150	Class C	1 / Pack
135219	200	200	Class C	1 / Pack

BRADY
Customise-it

See page 196 to order your custom-made signs.

i For all material properties and applications, see pages 4-5

Complies with EN ISO 7010

E053 : EMBARKATION LADDER



PHOTOLUMINESCENT SIGNS

Order Ref.	Width (mm)	Height (mm)	Class	Total Qty/ Pack
Class B Photoluminescent Polyester				
135226	150	150	Class B	1 / Pack
135227	200	200	Class B	1 / Pack
Class C Photoluminescent Polyester				
135232	150	150	Class C	1 / Pack
135233	200	200	Class C	1 / Pack
Class B Photoluminescent Polypropylene				
135222	150	150	Class B	1 / Pack
135223	200	200	Class B	1 / Pack
Class C Photoluminescent Polypropylene				
135228	150	150	Class C	1 / Pack
135229	200	200	Class C	1 / Pack
Class C Photoluminescent Aluminium				
135230	150	150	Class C	1 / Pack
135231	200	200	Class C	1 / Pack

Complies with EN ISO 7010

E054 : MARINE EVACUATION SLIDE



PHOTOLUMINESCENT SIGNS

Order Ref.	Width (mm)	Height (mm)	Class	Total Qty/ Pack
Class B Photoluminescent Polyester				
135250	150	150	Class B	1 / Pack
135251	200	200	Class B	1 / Pack
Class C Photoluminescent Polyester				
135256	150	150	Class C	1 / Pack
135257	200	200	Class C	1 / Pack
Class B Photoluminescent Polypropylene				
135246	150	150	Class B	1 / Pack
135247	200	200	Class B	1 / Pack
Class C Photoluminescent Polypropylene				
135252	150	150	Class C	1 / Pack
135253	200	200	Class C	1 / Pack
Class C Photoluminescent Aluminium				
135254	150	150	Class C	1 / Pack
135255	200	200	Class C	1 / Pack

Complies with EN ISO 7010

E055 : MARINE EVACUATION CHUTE



PHOTOLUMINESCENT SIGNS

Order Ref.	Width (mm)	Height (mm)	Class	Total Qty/ Pack
Class B Photoluminescent Polyester				
135238	150	150	Class B	1 / Pack
135239	200	200	Class B	1 / Pack
Class C Photoluminescent Polyester				
135244	150	150	Class C	1 / Pack
135245	200	200	Class C	1 / Pack
Class B Photoluminescent Polypropylene				
135234	150	150	Class B	1 / Pack
135235	200	200	Class B	1 / Pack
Class C Photoluminescent Polypropylene				
135240	150	150	Class C	1 / Pack
135241	200	200	Class C	1 / Pack
Class C Photoluminescent Aluminium				
135242	150	150	Class C	1 / Pack
135243	200	200	Class C	1 / Pack

Complies with EN ISO 7010

E056 : SURVIVAL CLOTHING



PHOTOLUMINESCENT SIGNS

Order Ref.	Width (mm)	Height (mm)	Class	Total Qty/ Pack
Class B Photoluminescent Polyester				
135262	150	150	Class B	1 / Pack
135263	200	200	Class B	1 / Pack
Class C Photoluminescent Polyester				
135268	150	150	Class C	1 / Pack
135269	200	200	Class C	1 / Pack
Class B Photoluminescent Polypropylene				
135258	150	150	Class B	1 / Pack
135259	200	200	Class B	1 / Pack
Class C Photoluminescent Polypropylene				
135264	150	150	Class C	1 / Pack
135265	200	200	Class C	1 / Pack
Class C Photoluminescent Aluminium				
135266	150	150	Class C	1 / Pack
135267	200	200	Class C	1 / Pack

BRADY
Customise-it

See page 196 to order your custom-made signs.

i For all material properties and applications, see pages 4-5

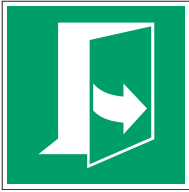

E057 : DOOR OPENS BY PULLING ON THE LEFT-HAND SIDE

In the event of an emergency evacuation, each second and each movement can make all the difference. Knowing which side of a door to pull to open it can therefore save lives and avoid additional stress. This symbol is available in a left-hand sign (E057) or right-hand sign (E058) version. There is also a symbol for pushing the left-hand side (E022) and the right-hand side (E023) of the door.



SIGNS

Order Ref.	Width (mm)	Height (mm)	Total Qty/ Pack
Laminated Polyester			
135276	100	100	1 / Pack
135277	148	148	1 / Pack
135278	200	200	1 / Pack
Polypropylene			
135270	100	100	1 / Pack
135271	148	148	1 / Pack
135272	200	200	1 / Pack
Aluminium			
135273	100	100	1 / Pack
135274	150	150	1 / Pack
135275	200	200	1 / Pack



PHOTOLUMINESCENT SIGNS

Order Ref.	Width (mm)	Height (mm)	Class	Total Qty/ Pack
Class B Photoluminescent Polyester				
135285	100	100	Class B	1 / Pack
135286	150	150	Class B	1 / Pack
135287	200	200	Class B	1 / Pack
Class C Photoluminescent Polyester				
135294	100	100	Class C	1 / Pack
135295	150	150	Class C	1 / Pack
135296	200	200	Class C	1 / Pack
Class B Photoluminescent Polypropylene				
135279	100	100	Class B	1 / Pack
135280	150	150	Class B	1 / Pack
135281	200	200	Class B	1 / Pack
Class C Photoluminescent Polypropylene				
135288	100	100	Class C	1 / Pack
135289	150	150	Class C	1 / Pack
135290	200	200	Class C	1 / Pack
Class C Photoluminescent Aluminium				
135291	100	100	Class C	1 / Pack
135292	150	150	Class C	1 / Pack
135293	200	200	Class C	1 / Pack

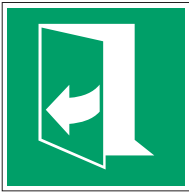

E058 : DOOR OPENS BY PULLING ON THE RIGHT-HAND SIDE

In the event of an emergency evacuation, each second and each movement can make all the difference. Knowing which side of a door to pull to open it can therefore save lives and avoid additional stress. This symbol is available in a left-hand sign (E057) or right-hand sign (E058) version. There is also a symbol for pushing the left-hand side (E022) and the right-hand side (E023) of the door.



SIGNS

Order Ref.	Width (mm)	Height (mm)	Total Qty/ Pack
Laminated Polyester			
135303	100	100	1 / Pack
135304	148	148	1 / Pack
135305	200	200	1 / Pack
Polypropylene			
135297	100	100	1 / Pack
135298	148	148	1 / Pack
135299	200	200	1 / Pack
Aluminium			
135300	100	100	1 / Pack
135301	150	150	1 / Pack
135302	200	200	1 / Pack



PHOTOLUMINESCENT SIGNS

Order Ref.	Width (mm)	Height (mm)	Class	Total Qty/ Pack
Class B Photoluminescent Polyester				
135312	100	100	Class B	1 / Pack
135313	150	150	Class B	1 / Pack
135314	200	200	Class B	1 / Pack
Class C Photoluminescent Polyester				
135321	100	100	Class C	1 / Pack
135322	150	150	Class C	1 / Pack
135323	200	200	Class C	1 / Pack
Class B Photoluminescent Polypropylene				
135306	100	100	Class B	1 / Pack
135307	150	150	Class B	1 / Pack
135308	200	200	Class B	1 / Pack
Class C Photoluminescent Polypropylene				
135315	100	100	Class C	1 / Pack
135316	150	150	Class C	1 / Pack
135317	200	200	Class C	1 / Pack
Class C Photoluminescent Aluminium				
135318	100	100	Class C	1 / Pack
135319	150	150	Class C	1 / Pack
135320	200	200	Class C	1 / Pack

BRADY
Customise-it

See page 196 to order your custom-made signs.



For all material properties and applications, see pages 4-5

Complies with EN ISO 7010

E059 : ESCAPE LADDER

Knowing that an escape ladder is available enables evacuation in complete safety from height.

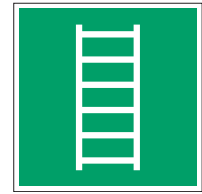

SIGNS

Order Ref.	Width (mm)	Height (mm)	Total Qty/ Pack
Laminated Polyester			
135330	100	100	1 / Pack
135331	148	148	1 / Pack
135332	200	200	1 / Pack
Polypropylene			
135324	100	100	1 / Pack
135325	148	148	1 / Pack
135326	200	200	1 / Pack
Aluminium			
135327	100	100	1 / Pack
135328	150	150	1 / Pack
135329	200	200	1 / Pack



PHOTOLUMINESCENT SIGNS

Order Ref.	Width (mm)	Height (mm)	Class	Total Qty/ Pack
Class B Photoluminescent Polyester				
135339	100	100	Class B	1 / Pack
135340	150	150	Class B	1 / Pack
135341	200	200	Class B	1 / Pack
Class C Photoluminescent Polyester				
135348	100	100	Class C	1 / Pack
135349	150	150	Class C	1 / Pack
135350	200	200	Class C	1 / Pack
Class B Photoluminescent Polypropylene				
135333	100	100	Class B	1 / Pack
135334	150	150	Class B	1 / Pack
135335	200	200	Class B	1 / Pack
Class C Photoluminescent Polypropylene				
135342	100	100	Class C	1 / Pack
135343	150	150	Class C	1 / Pack
135344	200	200	Class C	1 / Pack
Class C Photoluminescent Aluminium				
135345	100	100	Class C	1 / Pack
135346	150	150	Class C	1 / Pack
135347	200	200	Class C	1 / Pack

Complies with EN ISO 7010

E060 : EVACUATION CHAIR

The evacuation chair allows a person who is injured or who has reduced mobility to be evacuated more easily, and therefore more quickly.



SIGNS

Order Ref.	Width (mm)	Height (mm)	Total Qty/ Pack
Laminated Polyester			
135357	100	100	1 / Pack
135358	148	148	1 / Pack
135359	200	200	1 / Pack
Polypropylene			
135351	100	100	1 / Pack
135352	148	148	1 / Pack
135353	200	200	1 / Pack
Aluminium			
135354	100	100	1 / Pack
135355	150	150	1 / Pack
135356	200	200	1 / Pack



PHOTOLUMINESCENT SIGNS

Order Ref.	Width (mm)	Height (mm)	Class	Total Qty/ Pack
Class B Photoluminescent Polyester				
135366	100	100	Class B	1 / Pack
135367	150	150	Class B	1 / Pack
135368	200	200	Class B	1 / Pack
Class C Photoluminescent Polyester				
135375	100	100	Class C	1 / Pack
135376	150	150	Class C	1 / Pack
135377	200	200	Class C	1 / Pack
Class B Photoluminescent Polypropylene				
135360	100	100	Class B	1 / Pack
135361	150	150	Class B	1 / Pack
135362	200	200	Class B	1 / Pack
Class C Photoluminescent Polypropylene				
135369	100	100	Class C	1 / Pack
135370	150	150	Class C	1 / Pack
135371	200	200	Class C	1 / Pack
Class C Photoluminescent Aluminium				
135372	100	100	Class C	1 / Pack
135373	150	150	Class C	1 / Pack
135374	200	200	Class C	1 / Pack

BRADY
Customise-it

See page 196 to order your custom-made signs.

i For all material properties and applications, see pages 4-5



PIC 373: LEVELS (-2 TO +9)

Indicating the level in a stairwell helps people to know their location and to take the right direction, when evacuating as well as in everyday use. A glow-in-the-dark sign enables signage to remain visible even when there is a power cut.

SIGNS



Order Ref.	Width (mm)	Height (mm)	Total Qty/ Pack
Laminated Polyester			
250454	148	148	1 / Pack
222808	200	200	1 / Pack
Polypropylene			
252446	148	148	1 / Pack
222809	200	200	1 / Pack
227626	400	400	1 / Pack



Order Ref.	Width (mm)	Height (mm)	Total Qty/ Pack
Laminated Polyester			
250455	148	148	1 / Pack
222810	200	200	1 / Pack
Polypropylene			
252447	148	148	1 / Pack
222811	200	200	1 / Pack
227628	400	400	1 / Pack



Order Ref.	Width (mm)	Height (mm)	Total Qty/ Pack
Laminated Polyester			
250456	148	148	1 / Pack
222812	200	200	1 / Pack
Polypropylene			
252448	148	148	1 / Pack
222813	200	200	1 / Pack
227630	400	400	1 / Pack



Order Ref.	Width (mm)	Height (mm)	Total Qty/ Pack
Laminated Polyester			
250457	148	148	1 / Pack
222814	200	200	1 / Pack
227631	400	400	1 / Pack
Polypropylene			
252449	148	148	1 / Pack
222815	200	200	1 / Pack
227632	400	400	1 / Pack



Order Ref.	Width (mm)	Height (mm)	Total Qty/ Pack
Laminated Polyester			
250458	148	148	1 / Pack
222816	200	200	1 / Pack
227633	400	400	1 / Pack
Polypropylene			
227634	400	400	1 / Pack



Order Ref.	Width (mm)	Height (mm)	Total Qty/ Pack
Laminated Polyester			
250459	148	148	1 / Pack
222818	200	200	1 / Pack
227635	400	400	1 / Pack
Polypropylene			
252451	148	148	1 / Pack
222819	200	200	1 / Pack
227636	400	400	1 / Pack

PHOTOLUMINESCENT SIGNS



Order Ref.	Width (mm)	Height (mm)	Class	Total Qty/ Pack
Class C Photoluminescent Polyester				
134712	200	200	Class C	1 / Pack
Class C Photoluminescent Aluminium				
837009	150	150	Class C	1 / Pack
134707	200	200	Class C	1 / Pack



Order Ref.	Width (mm)	Height (mm)	Class	Total Qty/ Pack
Class C Photoluminescent Polyester				
134702	150	150	Class C	1 / Pack
836960	200	200	Class C	1 / Pack
Class C Photoluminescent Aluminium				
836955	150	150	Class C	1 / Pack
836957	200	200	Class C	1 / Pack



Order Ref.	Width (mm)	Height (mm)	Class	Total Qty/ Pack
Class C Photoluminescent Polyester				
134686	150	150	Class C	1 / Pack
Class B Photoluminescent Polyester				
834943	50	150	Class B	1 / Pack
834944	100	300	Class B	1 / Pack
Class B Photoluminescent Polypropylene				
834941	50	150	Class B	1 / Pack
834942	100	300	Class B	1 / Pack



Order Ref.	Width (mm)	Height (mm)	Class	Total Qty/ Pack
Class C Photoluminescent Polyester				
836952	200	200	Class C	1 / Pack
Class B Photoluminescent Polyester				
834949	50	150	Class B	1 / Pack
834951	100	300	Class B	1 / Pack
Class C Photoluminescent Aluminium				
836951	200	200	Class C	1 / Pack
Class B Photoluminescent Polypropylene				
834946	50	150	Class B	1 / Pack
834948	100	300	Class B	1 / Pack



Order Ref.	Width (mm)	Height (mm)	Class	Total Qty/ Pack
Class C Photoluminescent Polyester				
134687	200	200	Class C	1 / Pack
Class B Photoluminescent Polyester				
834955	50	150	Class B	1 / Pack
834957	100	300	Class B	1 / Pack
Class C Photoluminescent Aluminium				
837010	150	150	Class C	1 / Pack
836977	200	200	Class C	1 / Pack
Class B Photoluminescent Polypropylene				
834952	50	150	Class B	1 / Pack
834954	100	300	Class B	1 / Pack



Order Ref.	Width (mm)	Height (mm)	Class	Total Qty/ Pack
Class C Photoluminescent Polyester				
134688	150	150	Class C	1 / Pack
Class B Photoluminescent Polyester				
834961	50	150	Class B	1 / Pack
834962	100	300	Class B	1 / Pack
Class B Photoluminescent Polypropylene				
834958	50	150	Class B	1 / Pack
834960	100	300	Class B	1 / Pack



SIGNS



Order Ref.	Width (mm)	Height (mm)	Total Qty/ Pack
Laminated Polyester			
250460	148	148	1 / Pack
222820	200	200	1 / Pack
Polypropylene			
252452	148	148	1 / Pack
222821	200	200	1 / Pack
227638	400	400	1 / Pack



Order Ref.	Width (mm)	Height (mm)	Total Qty/ Pack
Laminated Polyester			
250461	148	148	1 / Pack
222822	200	200	1 / Pack
Polypropylene			
252453	148	148	1 / Pack
222823	200	200	1 / Pack
227640	400	400	1 / Pack



Order Ref.	Width (mm)	Height (mm)	Total Qty/ Pack
Laminated Polyester			
250462	148	148	1 / Pack
222824	200	200	1 / Pack
Polypropylene			
252454	148	148	1 / Pack
222825	200	200	1 / Pack
227642	400	400	1 / Pack



Order Ref.	Width (mm)	Height (mm)	Total Qty/ Pack
Laminated Polyester			
250463	148	148	1 / Pack
222826	200	200	1 / Pack
227643	400	400	1 / Pack
Polypropylene			
252455	148	148	1 / Pack
222827	200	200	1 / Pack
227644	400	400	1 / Pack



Order Ref.	Width (mm)	Height (mm)	Total Qty/ Pack
Laminated Polyester			
250464	148	148	1 / Pack
222828	200	200	1 / Pack
227645	400	400	1 / Pack
Polypropylene			
252456	148	148	1 / Pack
222829	200	200	1 / Pack
227646	400	400	1 / Pack



Order Ref.	Width (mm)	Height (mm)	Total Qty/ Pack
Laminated Polyester			
250474	148	148	1 / Pack
222830	200	200	1 / Pack
227647	400	400	1 / Pack
Polypropylene			
252457	148	148	1 / Pack
222831	200	200	1 / Pack
227648	400	400	1 / Pack

PHOTOLUMINESCENT SIGNS



Order Ref.	Width (mm)	Height (mm)	Class	Total Qty/ Pack
Class C Photoluminescent Polyester				
134689	150	150	Class C	1 / Pack
Class B Photoluminescent Polyester				
834977	50	150	Class B	1 / Pack
834978	100	300	Class B	1 / Pack
Class B Photoluminescent Polypropylene				
834975	50	150	Class B	1 / Pack
834976	100	300	Class B	1 / Pack



Order Ref.	Width (mm)	Height (mm)	Class	Total Qty/ Pack
Class C Photoluminescent Polyester				
134690	150	150	Class C	1 / Pack
Class B Photoluminescent Polyester				
834981	50	150	Class B	1 / Pack
834982	100	300	Class B	1 / Pack
Class B Photoluminescent Polypropylene				
834979	50	150	Class B	1 / Pack
834980	100	300	Class B	1 / Pack



Order Ref.	Width (mm)	Height (mm)	Class	Total Qty/ Pack
Class C Photoluminescent Polyester				
134692	150	150	Class C	1 / Pack
134693	200	200	Class C	1 / Pack
Class B Photoluminescent Polyester				
834985	50	150	Class B	1 / Pack
834987	100	300	Class B	1 / Pack
Class C Photoluminescent Aluminium				
134503	150	150	Class C	1 / Pack
Class B Photoluminescent Polypropylene				
834983	50	150	Class B	1 / Pack
834984	100	300	Class B	1 / Pack



Order Ref.	Width (mm)	Height (mm)	Class	Total Qty/ Pack
Class C Photoluminescent Polyester				
134695	150	150	Class C	1 / Pack
134696	200	200	Class C	1 / Pack
Class B Photoluminescent Polyester				
834993	50	150	Class B	1 / Pack
834994	100	300	Class B	1 / Pack
Class C Photoluminescent Aluminium				
134504	150	150	Class C	1 / Pack
Class B Photoluminescent Polypropylene				
834991	50	150	Class B	1 / Pack
834992	100	300	Class B	1 / Pack

























Order Ref.	Width (mm)	Height (mm)	Class	Total Qty/ Pack
Class C Photoluminescent Polyester				
134697	150	150	Class C	1 / Pack
134698	200	200	Class C	1 / Pack
Class B Photoluminescent Polyester				
834998	50	150	Class B	1 / Pack
834999	100	300	Class B	1 / Pack
Class B Photoluminescent Polypropylene				
834995	50	150	Class B	1 / Pack
834996	100	300	Class B	1 / Pack



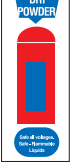







Order Ref.	Width (mm)	Height (mm)	Class	Total Qty/ Pack
Class C Photoluminescent Polyester				
134700	150	150	Class C	1 / Pack
134701	200	200	Class C	1 / Pack
Class C Photoluminescent Aluminium				
134505	150	150	Class C	1 / Pack

Fire safety

Symbol	Description	Page
	F001 : Fire extinguisher	53
	F002 : Fire hose reel	54
	F003 : Fire ladder	55
	F004 : Collection of fire-fighting equipment	56
	F004B : Collection of fire-fighting equipment	52
	F005 : Fire alarm call point	57
	F001/F002/F005 : Fire extinguisher/Fire alarm call point/Fire hose reel	58
	F001/F002 : Fire extinguisher/Fire hose reel	58
	F001/F005 : Fire extinguisher/Fire alarm call point	58
	F006 : Fire emergency telephone	59
	F007 : Fire protection door	60
	F008 : Fixed fire extinguishing battery	61
	F009 : Wheeled fire extinguisher	61
	F010 : Portable foam applicator unit	62
	F011 : Water fog applicator	62
	F012 : Fixed fire extinguisher installation	63

Symbol	Description	Page
	F013 : Fixed fire extinguisher bottle	63
	F014 : Remote release station	64
	F015 : Fire monitor	64
	F016 : Fire blanket	65
	A045R : Direction arrow 45°, top right corner	66
	A090R : Direction arrow 90°, to the right	66
	Know your fire extinguisher colour code	67
	Dry powder	67
	POWDER Class A B C	67
	Foam	67
	FOAM Class A B	67
	Water	67
	WATER Class A	67
	CO2	68

Symbol	Description	Page
	CO2 Class B	68
	Class ABC powder	68
	Foam spray	68
	Water	68
	Carbon dioxide	68
	Carbon dioxide	68
	Fire hose reel	68
	Class B C powder	68
	Wet chemical	68

Complies with EN ISO 7010

FO01 : FIRE EXTINGUISHER

The fire extinguisher must always be clearly indicated. This measure enables it to be found rapidly to prevent the spread of fire. Such indication should be placed at intermediate and upper height for optimal visibility under all circumstances. The photoluminescent version ensures an optimal localisation in the event of sudden darkness, without the need for any external energy source.



SIGNS

Order Ref.	Width (mm)	Height (mm)	Total Qty/ Pack
Laminated Polyester			
816878	100	100	1 / Pack
816879	148	148	1 / Pack
816880	200	200	1 / Pack
816881	250	250	1 / Pack
816883	315	315	1 / Pack
816884	400	400	1 / Pack
Polypropylene			
816886	100	100	1 / Pack
816887	148	148	1 / Pack
816888	200	200	1 / Pack
816889	250	250	1 / Pack
816891	315	315	1 / Pack
816892	400	400	1 / Pack
Aluminium			
816893	100	100	1 / Pack
816894	200	200	1 / Pack

FLOOR MARKING

Order Ref.	Width (mm)	Height (mm)	Total Qty/ Pack
Anti-skid Laminated Polyester			
816885	500	500	1 / Pack

MINI-PICTOGRAMS

Order Ref.	Width (mm)	Height (mm)	Total Qty/ Pack
Vinyl			
816876	10	10	96 / Pack



Bi-directional



Panoramic



Bi-directional



Panoramic

BI-DIRECTIONAL SIGNS

Order Ref.	Width (mm)	Height (mm)	Layout	Total Qty/ Pack
Polyvinylchloride				
816895	151	151	Bi-directional	1 / Pack
816896	203	203	Bi-directional	1 / Pack
816897	253	253	Bi-directional	1 / Pack
816898	318	318	Bi-directional	1 / Pack
816899	151	151	Panoramic	1 / Pack
816900	203	203	Panoramic	1 / Pack
816901	253	253	Panoramic	1 / Pack
816902	318	318	Panoramic	1 / Pack

BI-DIRECTIONAL PHOTOLUMINESCENT SIGNS

Order Ref.	Width (mm)	Height (mm)	Layout	Class	Total Qty/ Pack
Class B Photoluminescent Polyvinylchloride					
836681	203	203	Panoramic	Class B	1 / Pack
Class C Photoluminescent Polyvinylchloride					
134719	150	150	Bi-directional	Class C	1 / Pack
836961	151	151	Bi-directional	Class C	1 / Pack
836963	200	200	Bi-directional	Class C	1 / Pack
134720	200	200	Bi-directional	Class C	1 / Pack
836962	203	203	Bi-directional	Class C	1 / Pack
134721	250	250	Bi-directional	Class C	1 / Pack
134722	315	315	Bi-directional	Class C	1 / Pack
836966	151	151	Panoramic	Class C	1 / Pack
836967	203	203	Panoramic	Class C	1 / Pack
836968	303	303	Panoramic	Class C	1 / Pack



PHOTOLUMINESCENT SIGNS

Order Ref.	Width (mm)	Height (mm)	Class	Total Qty/ Pack
Class B Photoluminescent Polyester				
835156	150	150	Class B	1 / Pack
835157	200	200	Class B	1 / Pack
Class C Photoluminescent Polyester				
835159	150	150	Class C	1 / Pack
835161	200	200	Class C	1 / Pack
836677	300	300	Class C	1 / Pack
836965	400	400	Class C	1 / Pack
Class B Photoluminescent Polypropylene				
835135	150	150	Class B	1 / Pack
835136	200	200	Class B	1 / Pack
836676	300	300	Class B	1 / Pack
Class C Photoluminescent Polypropylene				
835149	200	200	Class C	1 / Pack
Class C Photoluminescent Self-adhesive Polypropylene				
836678	150	150	Class C	1 / Pack
836679	200	200	Class C	1 / Pack
836680	300	300	Class C	1 / Pack
Class C Photoluminescent Aluminium				
835129	150	150	Class C	1 / Pack
835130	200	200	Class C	1 / Pack
836675	300	300	Class C	1 / Pack

SIGNS WITH TEXT



Order Ref.	Width (mm)	Height (mm)	Layout	Legend	Total Qty/ Pack
Laminated Polyester					
816950	150	50	Landscape	Fire extinguisher	1/ Pack
816951	297	74	Landscape	Fire extinguisher	1/ Pack
816952	297	105	Landscape	Fire extinguisher	1/ Pack
816953	450	150	Landscape	Fire extinguisher	1/ Pack
816954	600	200	Landscape	Fire extinguisher	1/ Pack
816947	148	210	Portrait	Fire extinguisher	1/ Pack
816948	210	297	Portrait	Fire extinguisher	1/ Pack
816949	297	420	Portrait	Fire extinguisher	1/ Pack
Polypropylene					
816958	150	50	Landscape	Fire extinguisher	1/ Pack
816959	297	74	Landscape	Fire extinguisher	1/ Pack
816960	297	105	Landscape	Fire extinguisher	1/ Pack
816961	450	150	Landscape	Fire extinguisher	1/ Pack
816962	600	200	Landscape	Fire extinguisher	1/ Pack
816955	148	210	Portrait	Fire extinguisher	1/ Pack
816956	210	297	Portrait	Fire extinguisher	1/ Pack
816957	297	420	Portrait	Fire extinguisher	1/ Pack
Aluminium					
816966	150	50	Landscape	Fire extinguisher	1/ Pack
816967	297	105	Landscape	Fire extinguisher	1/ Pack
816968	450	150	Landscape	Fire extinguisher	1/ Pack
816963	148	210	Portrait	Fire extinguisher	1/ Pack
816964	210	297	Portrait	Fire extinguisher	1/ Pack
816965	297	420	Portrait	Fire extinguisher	1/ Pack



PICTOGRAMS ON ROLLS

Order Ref.	Width (mm)	Height (mm)	Total Qty/ Pack
Laminated Polyester			
816877	100	100	250 / Roll



"Fire extinguishers must be placed on pillars or on walls, in very open areas, preferably at the workshops and other premises entrance or near machines where fires can occur. Unless specific reasons, fire extinguishers must be uniformly distributed. No-one should ever be more than 16 yards from a fire extinguisher. Fire extinguishers must be easily accessible and visible or clearly indicated by a sign. - The Health and Safety (Safety Signs and Signals) Regulations 1996.



F002 : FIRE HOSE REEL

The fire hose reel must be located quickly in case of fire. Marking at intermediate and upper height is recommended for visibility under all circumstances.



SIGNS

Order Ref.	Width (mm)	Height (mm)	Total Qty/ Pack
Laminated Polyester			
817037	100	100	1 / Pack
817038	148	148	1 / Pack
817039	200	200	1 / Pack
817040	250	250	1 / Pack
817042	315	315	1 / Pack
817043	400	400	1 / Pack
Polypropylene			
817045	100	100	1 / Pack
817046	148	148	1 / Pack
817047	200	200	1 / Pack
817048	250	250	1 / Pack
817050	315	315	1 / Pack
817051	400	400	1 / Pack
Aluminium			
817052	100	100	1 / Pack
817053	200	200	1 / Pack

FLOOR MARKING

Order Ref.	Width (mm)	Height (mm)	Total Qty/ Pack
Anti-skid Laminated Polyester			
817044	500	500	1 / Pack

MINI-PICTOGRAMS

Order Ref.	Width (mm)	Height (mm)	Total Qty/ Pack
Vinyl			
817035	10	10	96 / Pack



PHOTOLUMINESCENT SIGNS

Order Ref.	Width (mm)	Height (mm)	Class	Total Qty/ Pack
Class B Photoluminescent Polyester				
836685	200	200	Class B	1 / Pack
Class C Photoluminescent Polyester				
835198	150	150	Class C	1 / Pack
835203	200	200	Class C	1 / Pack
836686	300	300	Class C	1 / Pack
836970	400	400	Class C	1 / Pack
Class B Photoluminescent Polypropylene				
836683	200	200	Class B	1 / Pack
836684	300	300	Class B	1 / Pack
Class C Photoluminescent Self-adhesive Polypropylene				
836687	150	150	Class C	1 / Pack
836688	200	200	Class C	1 / Pack
836689	300	300	Class C	1 / Pack
Class C Photoluminescent Aluminium				
835183	150	150	Class C	1 / Pack
835185	200	200	Class C	1 / Pack
836682	300	300	Class C	1 / Pack



PICTOGRAMS ON ROLLS

Order Ref.	Width (mm)	Height (mm)	Total Qty/ Pack
Laminated Polyester			
817036	100	100	250 / Roll

i For all material properties and applications, see pages 4-5

BRADY Customise-it See page 196 to order your custom-made signs.



Bi-directional



Panoramic

BI-DIRECTIONAL SIGNS

Order Ref.	Width (mm)	Height (mm)	Layout	Total Qty/ Pack
Polyvinylchloride				
817054	151	151	Bi-directional	1 / Pack
817055	203	203	Bi-directional	1 / Pack
817056	253	253	Bi-directional	1 / Pack
817057	318	318	Bi-directional	1 / Pack
817058	151	151	Panoramic	1 / Pack
817059	203	203	Panoramic	1 / Pack
817060	253	253	Panoramic	1 / Pack
817061	318	318	Panoramic	1 / Pack



Bi-directional



Panoramic

BI-DIRECTIONAL PHOTOLUMINESCENT SIGNS

Order Ref.	Width (mm)	Height (mm)	Layout	Class	Total Qty/ Pack
Class B Photoluminescent Polyvinylchloride					
836690	203	203	Panoramic	Class B	1 / Pack
Class C Photoluminescent Polyvinylchloride					
134724	151	151	Bi-directional	Class C	1 / Pack
836969	203	203	Bi-directional	Class C	1 / Pack
134725	318	318	Bi-directional	Class C	1 / Pack
836971	203	203	Panoramic	Class C	1 / Pack

SIGNS WITH TEXT



Order Ref.	Width (mm)	Height (mm)	Layout	Legend	Total Qty/ Pack
Laminated Polyester					
817109	150	50	Landscape	Fire hose reel	1/Pack
817110	297	74	Landscape	Fire hose reel	1/Pack
817111	297	105	Landscape	Fire hose reel	1/Pack
817112	450	150	Landscape	Fire hose reel	1/Pack
817113	600	200	Landscape	Fire hose reel	1/Pack
817106	148	210	Portrait	Fire hose reel	1/Pack
817107	210	297	Portrait	Fire hose reel	1/Pack
817108	297	420	Portrait	Fire hose reel	1/Pack
Polypropylene					
817117	150	50	Landscape	Fire hose reel	1/Pack
817118	297	74	Landscape	Fire hose reel	1/Pack
817119	297	105	Landscape	Fire hose reel	1/Pack
817120	450	150	Landscape	Fire hose reel	1/Pack
817121	600	200	Landscape	Fire hose reel	1/Pack
817114	148	210	Portrait	Fire hose reel	1/Pack
817115	210	297	Portrait	Fire hose reel	1/Pack
817116	297	420	Portrait	Fire hose reel	1/Pack
Aluminium					
817125	150	50	Landscape	Fire hose reel	1/Pack
817126	297	105	Landscape	Fire hose reel	1/Pack
817127	450	150	Landscape	Fire hose reel	1/Pack
817122	148	210	Portrait	Fire hose reel	1/Pack
817123	210	297	Portrait	Fire hose reel	1/Pack
817124	297	420	Portrait	Fire hose reel	1/Pack

Complies with EN ISO 7010

F003 : FIRE LADDER

Fire ladders facilitate evacuation in case of fire.



SIGNS

Order Ref.	Width (mm)	Height (mm)	Total Qty/ Pack
Laminated Polyester			
817196	100	100	1 / Pack
817197	148	148	1 / Pack
817198	200	200	1 / Pack
817199	250	250	1 / Pack
817201	315	315	1 / Pack
817202	400	400	1 / Pack
Polypropylene			
817204	100	100	1 / Pack
817205	148	148	1 / Pack
817207	250	250	1 / Pack
817209	315	315	1 / Pack
817210	400	400	1 / Pack
Aluminium			
817211	100	100	1 / Pack
817212	200	200	1 / Pack



Bi-directional



Panoramic

BI-DIRECTIONAL SIGNS

Order Ref.	Width (mm)	Height (mm)	Layout	Total Qty/ Pack
Polyvinylchloride				
817213	151	151	Bi-directional	1 / Pack
817214	203	203	Bi-directional	1 / Pack
817215	253	253	Bi-directional	1 / Pack
817216	318	318	Bi-directional	1 / Pack
817217	151	151	Panoramic	1 / Pack
817218	203	203	Panoramic	1 / Pack
817219	253	253	Panoramic	1 / Pack
817220	318	318	Panoramic	1 / Pack

FLOOR MARKING

Order Ref.	Width (mm)	Height (mm)	Total Qty/ Pack
Anti-skid Laminated Polyester			
817203	500	500	1 / Pack

MINI-PICTOGRAMS

Order Ref.	Width (mm)	Height (mm)	Total Qty/ Pack
Vinyl			
817194	10	10	96 / Pack

SIGNS WITH TEXT



Order Ref.	Width (mm)	Height (mm)	Layout	Legend	Total Qty/ Pack
Laminated Polyester					
817268	150	50	Landscape	Fire ladder	1/Pack
817269	297	74	Landscape	Fire ladder	1/Pack
817270	297	105	Landscape	Fire ladder	1/Pack
817271	450	150	Landscape	Fire ladder	1/Pack
817272	600	200	Landscape	Fire ladder	1/Pack
817265	148	210	Portrait	Fire ladder	1/Pack
817266	210	297	Portrait	Fire ladder	1/Pack
817267	297	420	Portrait	Fire ladder	1/Pack
Polypropylene					
817276	150	50	Landscape	Fire ladder	1/Pack
817277	297	74	Landscape	Fire ladder	1/Pack
817278	297	105	Landscape	Fire ladder	1/Pack
817279	450	150	Landscape	Fire ladder	1/Pack
817280	600	200	Landscape	Fire ladder	1/Pack
817273	148	210	Portrait	Fire ladder	1/Pack
817274	210	297	Portrait	Fire ladder	1/Pack
817275	297	420	Portrait	Fire ladder	1/Pack
Aluminium					
817284	150	50	Landscape	Fire ladder	1/Pack
817285	297	105	Landscape	Fire ladder	1/Pack
817286	450	150	Landscape	Fire ladder	1/Pack
817281	148	210	Portrait	Fire ladder	1/Pack
817282	210	297	Portrait	Fire ladder	1/Pack
817283	297	420	Portrait	Fire ladder	1/Pack



PHOTOLUMINESCENT SIGNS

Order Ref.	Width (mm)	Height (mm)	Class	Total Qty/ Pack
Class B Photoluminescent Polyester				
836694	150	150	Class B	1 / Pack
836695	200	200	Class B	1 / Pack
Class C Photoluminescent Polyester				
835213	150	150	Class C	1 / Pack
835214	200	200	Class C	1 / Pack
836696	300	300	Class C	1 / Pack
Class B Photoluminescent Polypropylene				
836692	200	200	Class B	1 / Pack
836693	300	300	Class B	1 / Pack
Class C Photoluminescent Self-adhesive Polypropylene				
836697	150	150	Class C	1 / Pack
836698	200	200	Class C	1 / Pack
836699	300	300	Class C	1 / Pack
Class C Photoluminescent Aluminium				
835210	150	150	Class C	1 / Pack
835212	200	200	Class C	1 / Pack
836691	300	300	Class C	1 / Pack



PICTOGRAMS ON ROLLS

Order Ref.	Width (mm)	Height (mm)	Total Qty/ Pack
Laminated Polyester			
817195	100	100	250 / Roll

i For all material properties and applications, see pages 4-5

BRADY Customise-it See page 196 to order your custom-made signs.



F004 : COLLECTION OF FIRE-FIGHTING EQUIPMENT

The fire-fighter's helmet symbolises the storage location for the fire-fighting equipment.



SIGNS

Order Ref.	Width (mm)	Height (mm)	Total Qty/ Pack
Laminated Polyester			
817355	100	100	1 / Pack
817356	148	148	1 / Pack
817357	200	200	1 / Pack
817358	250	250	1 / Pack
817360	315	315	1 / Pack
817361	400	400	1 / Pack
Polypropylene			
817363	100	100	1 / Pack
817364	148	148	1 / Pack
817365	200	200	1 / Pack
817366	250	250	1 / Pack
817368	315	315	1 / Pack
817369	400	400	1 / Pack
Aluminium			
817370	100	100	1 / Pack
817371	200	200	1 / Pack

FLOOR MARKING

Order Ref.	Width (mm)	Height (mm)	Total Qty/ Pack
Anti-skid Laminated Polyester			
817362	500	500	1 / Pack

MINI-PICTOGRAMS

Order Ref.	Width (mm)	Height (mm)	Total Qty/ Pack
Vinyl			
817353	10	10	96 / Pack



PICTOGRAMS ON ROLLS

Order Ref.	Width (mm)	Height (mm)	Total Qty/ Pack
Laminated Polyester			
817354	100	100	250 / Roll



PHOTOLUMINESCENT SIGNS

Order Ref.	Width (mm)	Height (mm)	Class	Total Qty/ Pack
Class B Photoluminescent Polyester				
836704	150	150	Class B	1 / Pack
836714	200	200	Class B	1 / Pack
Class C Photoluminescent Polyester				
835237	150	150	Class C	1 / Pack
835241	200	200	Class C	1 / Pack
Class B Photoluminescent Polypropylene				
835254	150	150	Class B	1 / Pack
835257	200	200	Class B	1 / Pack
836720	300	300	Class B	1 / Pack
Class C Photoluminescent Self-adhesive Polypropylene				
836715	150	150	Class C	1 / Pack
836716	200	200	Class C	1 / Pack
836717	300	300	Class C	1 / Pack
Class C Photoluminescent Aluminium				
835233	150	150	Class C	1 / Pack
835235	200	200	Class C	1 / Pack
836703	300	300	Class C	1 / Pack



Panoramic

BI-DIRECTIONAL PHOTOLUMINESCENT SIGNS

Order Ref.	Width (mm)	Height (mm)	Layout	Class	Total Qty/ Pack
Class B Photoluminescent Polyvinylchloride					
836719	203	203	Panoramic	Class B	1 / Pack



Bi-directional



Panoramic

BI-DIRECTIONAL SIGNS

Order Ref.	Width (mm)	Height (mm)	Layout	Total Qty/ Pack
Polyvinylchloride				
817372	151	151	Bi-directional	1 / Pack
817373	203	203	Bi-directional	1 / Pack
817374	253	253	Bi-directional	1 / Pack
817375	318	318	Bi-directional	1 / Pack
817376	151	151	Panoramic	1 / Pack
817377	203	203	Panoramic	1 / Pack
817378	253	253	Panoramic	1 / Pack
817379	318	318	Panoramic	1 / Pack

SIGNS WITH TEXT



Order Ref.	Width (mm)	Height (mm)	Layout	Legend	Total Qty/ Pack
Laminated Polyester					
817427	150	50	Landscape	Collection of fire-fighting equipment	1/Pack
817428	297	74	Landscape	Collection of fire-fighting equipment	1/Pack
817429	297	105	Landscape	Collection of fire-fighting equipment	1/Pack
817430	450	150	Landscape	Collection of fire-fighting equipment	1/Pack
817431	600	200	Landscape	Collection of fire-fighting equipment	1/Pack
817424	148	210	Portrait	Collection of fire-fighting equipment	1/Pack
817425	210	297	Portrait	Collection of fire-fighting equipment	1/Pack
817426	297	420	Portrait	Collection of fire-fighting equipment	1/Pack
Polypropylene					
817435	150	50	Landscape	Collection of fire-fighting equipment	1/Pack
817436	297	74	Landscape	Collection of fire-fighting equipment	1/Pack
817437	297	105	Landscape	Collection of fire-fighting equipment	1/Pack
817438	450	150	Landscape	Collection of fire-fighting equipment	1/Pack
817439	600	200	Landscape	Collection of fire-fighting equipment	1/Pack
817432	148	210	Portrait	Collection of fire-fighting equipment	1/Pack
817433	210	297	Portrait	Collection of fire-fighting equipment	1/Pack
817434	297	420	Portrait	Collection of fire-fighting equipment	1/Pack
Aluminium					
817443	150	50	Landscape	Collection of fire-fighting equipment	1/Pack
817444	297	105	Landscape	Collection of fire-fighting equipment	1/Pack
817445	450	150	Landscape	Collection of fire-fighting equipment	1/Pack
817440	148	210	Portrait	Collection of fire-fighting equipment	1/Pack
817441	210	297	Portrait	Collection of fire-fighting equipment	1/Pack
817442	297	420	Portrait	Collection of fire-fighting equipment	1/Pack

Complies with EN ISO 7010

FO05 : FIRE ALARM CALL POINT

Sounding the alarm as quickly as possible can save lives in the event of fire, therefore being able to locate the alarm point quickly, is crucial.



SIGNS

Order Ref.	Width (mm)	Height (mm)	Total Qty/ Pack
Laminated Polyester			
817673	100	100	1 / Pack
817674	148	148	1 / Pack
817675	200	200	1 / Pack
817676	250	250	1 / Pack
817678	315	315	1 / Pack
817679	400	400	1 / Pack
Polypropylene			
817682	148	148	1 / Pack
817683	200	200	1 / Pack
817684	250	250	1 / Pack
817686	315	315	1 / Pack
817687	400	400	1 / Pack
Aluminium			
817688	100	100	1 / Pack
817689	200	200	1 / Pack

FLOOR MARKING

Order Ref.	Width (mm)	Height (mm)	Total Qty/ Pack
Anti-skid Laminated Polyester			
817680	500	500	1 / Pack

MINI-PICTOGRAMS

Order Ref.	Width (mm)	Height (mm)	Total Qty/ Pack
Vinyl			
817671	10	10	96 / Pack



PHOTOLUMINESCENT SIGNS

Order Ref.	Width (mm)	Height (mm)	Class	Total Qty/ Pack
Class B Photoluminescent Polyester				
835342	100	100	Class B	1 / Pack
836729	150	150	Class B	1 / Pack
835343	200	200	Class B	1 / Pack
Class C Photoluminescent Polyester				
835345	150	150	Class C	1 / Pack
835346	200	200	Class C	1 / Pack
836725	300	300	Class C	1 / Pack
836972	400	400	Class C	1 / Pack
Class B Photoluminescent Polypropylene				
835338	200	200	Class B	1 / Pack
836728	300	300	Class B	1 / Pack
Class C Photoluminescent Polypropylene				
835341	200	200	Class C	1 / Pack
Class C Photoluminescent Self-adhesive Polypropylene				
836726	150	150	Class C	1 / Pack
836727	200	200	Class C	1 / Pack
Class C Photoluminescent Aluminium				
835336	150	150	Class C	1 / Pack
835337	200	200	Class C	1 / Pack

PICTOGRAMS ON ROLLS

Order Ref.	Width (mm)	Height (mm)	Total Qty/Pack
Laminated Polyester			
817672	100	100	250 / Roll



Bi-directional



Panoramic



Bi-directional



Panoramic

BI-DIRECTIONAL SIGNS

Order Ref.	Width (mm)	Height (mm)	Layout	Total Qty/ Pack
Polyvinylchloride				
817690	151	151	Bi-directional	1 / Pack
817691	203	203	Bi-directional	1 / Pack
817692	253	253	Bi-directional	1 / Pack
817693	318	318	Bi-directional	1 / Pack
817694	151	151	Panoramic	1 / Pack
817695	203	203	Panoramic	1 / Pack
817696	253	253	Panoramic	1 / Pack
817697	318	318	Panoramic	1 / Pack

BI-DIRECTIONAL PHOTOLUMINESCENT SIGNS

Order Ref.	Width (mm)	Height (mm)	Layout	Class	Total Qty/ Pack
Class B Photoluminescent Polyvinylchloride					
836730	203	203	Panoramic	Class B	1 / Pack
Class C Photoluminescent Polyvinylchloride					
134728	151	151	Bi-directional	Class C	1 / Pack
134729	318	318	Bi-directional	Class C	1 / Pack
134730	151	151	Panoramic	Class C	1 / Pack
134731	253	253	Panoramic	Class C	1 / Pack
134732	318	318	Panoramic	Class C	1 / Pack

SIGNS WITH TEXT



Order Ref.	Width (mm)	Height (mm)	Layout	Legend	Total Qty/ Pack
Laminated Polyester					
817745	150	50	Landscape	Fire alarm call point	1/Pack
817746	297	74	Landscape	Fire alarm call point	1/Pack
817747	297	105	Landscape	Fire alarm call point	1/Pack
817748	450	150	Landscape	Fire alarm call point	1/Pack
817749	600	200	Landscape	Fire alarm call point	1/Pack
817742	148	210	Portrait	Fire alarm call point	1/Pack
817743	210	297	Portrait	Fire alarm call point	1/Pack
817744	297	420	Portrait	Fire alarm call point	1/Pack
Polypropylene					
817753	150	50	Landscape	Fire alarm call point	1/Pack
817754	297	74	Landscape	Fire alarm call point	1/Pack
817755	297	105	Landscape	Fire alarm call point	1/Pack
817756	450	150	Landscape	Fire alarm call point	1/Pack
817757	600	200	Landscape	Fire alarm call point	1/Pack
817750	148	210	Portrait	Fire alarm call point	1/Pack
817751	210	297	Portrait	Fire alarm call point	1/Pack
817752	297	420	Portrait	Fire alarm call point	1/Pack
Aluminium					
817761	150	50	Landscape	Fire alarm call point	1/Pack
817762	297	105	Landscape	Fire alarm call point	1/Pack
817763	450	150	Landscape	Fire alarm call point	1/Pack
817758	148	210	Portrait	Fire alarm call point	1/Pack
817759	210	297	Portrait	Fire alarm call point	1/Pack
817760	297	420	Portrait	Fire alarm call point	1/Pack

i For all material properties and applications, see pages 4-5

BRADY Customise-it See page 196 to order your custom-made signs.

Combination signs enable the identification of different fire-fighting elements grouped in the same place.

Complies with EN ISO 7010

F001/F002/F005 : FIRE EXTINGUISHER/FIRE ALARM CALL POINT/FIRE HOSE REEL

BI-DIRECTIONAL SIGNS

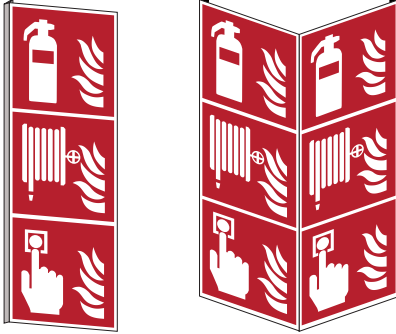

Bi-directional

Panoramic

Order Ref.	Width (mm)	Height (mm)	Layout	Total Qty/ Pack
Polyvinylchloride				
139164	151	453	Bi-directional	1 / Pack
138935	203	603	Bi-directional	1 / Pack
138936	203	603	Panoramic	1 / Pack

BI-DIRECTIONAL PHOTOLUMINESCENT SIGNS



Bi-directional

Panoramic

Order Ref.	Width (mm)	Height (mm)	Layout	Class	Total Qty/ Pack
Class C Photoluminescent Polyvinylchloride					
134714	203	603	Bi-directional	Class C	1 / Pack
134715	151	453	Panoramic	Class C	1 / Pack

Complies with EN ISO 7010

F001/F002 : FIRE EXTINGUISHER/FIRE HOSE REEL



Bi-directional

BI-DIRECTIONAL SIGNS

Order Ref.	Width (mm)	Height (mm)	Layout	Total Qty/ Pack
Polyvinylchloride				
139162	203	403	Bi-directional	1 / Pack



Panoramic

BI-DIRECTIONAL PHOTOLUMINESCENT SIGNS

Order Ref.	Width (mm)	Height (mm)	Layout	Class	Total Qty/ Pack
Class C Photoluminescent Polyvinylchloride					
134713	203	403	Panoramic	Class C	1 / Pack

Complies with EN ISO 7010

F001/F005 : FIRE EXTINGUISHER/FIRE ALARM CALL POINT



Bi-directional

BI-DIRECTIONAL SIGNS

Order Ref.	Width (mm)	Height (mm)	Layout	Total Qty/ Pack
Polyvinylchloride				
139163	203	403	Bi-directional	1 / Pack
139244	203	403	Panoramic	1 / Pack



Bi-directional

BI-DIRECTIONAL PHOTOLUMINESCENT SIGNS

Order Ref.	Width (mm)	Height (mm)	Layout	Class	Total Qty/ Pack
Class C Photoluminescent Polyvinylchloride					
134723	203	203	Bi-directional	Class C	1 / Pack
134716	203	403	Panoramic	Class C	1 / Pack
134718	203	603	Panoramic	Class C	1 / Pack



Panoramic



Panoramic

Complies with EN ISO 7010

FO06 : FIRE EMERGENCY TELEPHONE

The telephone enables emergency services to be contacted immediately for an emergency response in case of fire.



SIGNS

Order Ref.	Width (mm)	Height (mm)	Total Qty/ Pack
Laminated Polyester			
817832	100	100	1 / Pack
817833	148	148	1 / Pack
817834	200	200	1 / Pack
817835	250	250	1 / Pack
817837	315	315	1 / Pack
817838	400	400	1 / Pack
Polypropylene			
817840	100	100	1 / Pack
817841	148	148	1 / Pack
817842	200	200	1 / Pack
817843	250	250	1 / Pack
817845	315	315	1 / Pack
817846	400	400	1 / Pack
Aluminium			
817847	100	100	1 / Pack
817848	200	200	1 / Pack

FLOOR MARKING

Order Ref.	Width (mm)	Height (mm)	Total Qty/ Pack
Anti-skid Laminated Polyester			
817839	500	500	1 / Pack

MINI-PICTOGRAMS

Order Ref.	Width (mm)	Height (mm)	Total Qty/ Pack
Vinyl			
817830	10	10	96 / Pack



PHOTOLUMINESCENT SIGNS

Order Ref.	Width (mm)	Height (mm)	Class	Total Qty/ Pack
Class B Photoluminescent Polyester				
836739	150	150	Class B	1 / Pack
836741	200	200	Class B	1 / Pack
Class C Photoluminescent Polyester				
835372	150	150	Class C	1 / Pack
835374	200	200	Class C	1 / Pack
Class B Photoluminescent Polypropylene				
836737	200	200	Class B	1 / Pack
836738	300	300	Class B	1 / Pack
Class C Photoluminescent Self-adhesive Polypropylene				
836742	150	150	Class C	1 / Pack
836743	200	200	Class C	1 / Pack
Class C Photoluminescent Aluminium				
835349	150	150	Class C	1 / Pack
835364	200	200	Class C	1 / Pack
836735	300	300	Class C	1 / Pack



PICTOGRAMS ON ROLLS

Order Ref.	Width (mm)	Height (mm)	Total Qty/ Pack
Laminated Polyester			
817831	100	100	250 / Roll



Bi-directional



Panoramic



Bi-directional



Panoramic

BI-DIRECTIONAL SIGNS

Order Ref.	Width (mm)	Height (mm)	Layout	Total Qty/ Pack
Polyvinylchloride				
817849	151	151	Bi-directional	1 / Pack
817850	203	203	Bi-directional	1 / Pack
817851	253	253	Bi-directional	1 / Pack
817852	318	318	Bi-directional	1 / Pack
817853	151	151	Panoramic	1 / Pack
817854	203	203	Panoramic	1 / Pack
817855	253	253	Panoramic	1 / Pack
817856	318	318	Panoramic	1 / Pack

BI-DIRECTIONAL PHOTOLUMINESCENT SIGNS

Order Ref.	Width (mm)	Height (mm)	Layout	Class	Total Qty/ Pack
Class B Photoluminescent Polyvinylchloride					
836744	203	203	Panoramic	Class B	1 / Pack
Class C Photoluminescent Polyvinylchloride					
139257	151	151	Bi-directional	Class C	1 / Pack
134733	203	203	Bi-directional	Class C	1 / Pack
134734	253	253	Bi-directional	Class C	1 / Pack
134735	318	318	Bi-directional	Class C	1 / Pack
134736	151	151	Panoramic	Class C	1 / Pack
134737	253	253	Panoramic	Class C	1 / Pack
134738	318	318	Panoramic	Class C	1 / Pack

SIGNS WITH TEXT



Order Ref.	Width (mm)	Height (mm)	Layout	Legend	Total Qty/ Pack
Laminated Polyester					
817904	150	50	Landscape	Fire emergency telephone	1/Pack
817905	297	74	Landscape	Fire emergency telephone	1/Pack
817906	297	105	Landscape	Fire emergency telephone	1/Pack
817907	450	150	Landscape	Fire emergency telephone	1/Pack
817908	600	200	Landscape	Fire emergency telephone	1/Pack
817901	148	210	Portrait	Fire emergency telephone	1/Pack
817902	210	297	Portrait	Fire emergency telephone	1/Pack
817903	297	420	Portrait	Fire emergency telephone	1/Pack
Polypropylene					
817912	150	50	Landscape	Fire emergency telephone	1/Pack
817913	297	74	Landscape	Fire emergency telephone	1/Pack
817914	297	105	Landscape	Fire emergency telephone	1/Pack
817915	450	150	Landscape	Fire emergency telephone	1/Pack
817916	600	200	Landscape	Fire emergency telephone	1/Pack
817909	148	210	Portrait	Fire emergency telephone	1/Pack
817910	210	297	Portrait	Fire emergency telephone	1/Pack
817911	297	420	Portrait	Fire emergency telephone	1/Pack
Aluminium					
817920	150	50	Landscape	Fire emergency telephone	1/Pack
817921	297	105	Landscape	Fire emergency telephone	1/Pack
817922	450	150	Landscape	Fire emergency telephone	1/Pack
817917	148	210	Portrait	Fire emergency telephone	1/Pack
817918	210	297	Portrait	Fire emergency telephone	1/Pack
817919	297	420	Portrait	Fire emergency telephone	1/Pack

i For all material properties and applications, see pages 4-5

BRADY Customise-it See page 196 to order your custom-made signs.



F007 : FIRE PROTECTION DOOR

Fire protection doors are part of a system to reduce the spread of fire and smoke between separate compartments of a structure and enable evacuation in case of a fire. Clearly marking fire protection doors will ensure people are aware they should not be left open.



SIGNS

Order Ref.	Width (mm)	Height (mm)	Total Qty/ Pack
Laminated Polyester			
197848	100	100	1 / Pack
197851	100	100	1 / Pack
197849	148	148	1 / Pack
197850	200	200	1 / Pack
Polypropylene			
197852	148	148	1 / Pack
197853	200	200	1 / Pack
Aluminium			
197854	100	100	1 / Pack
197855	150	150	1 / Pack
197856	200	200	1 / Pack



PHOTOLUMINESCENT SIGNS

Order Ref.	Width (mm)	Height (mm)	Class	Total Qty/ Pack
Class B Photoluminescent Polyester				
197859	100	100	Class B	1 / Pack
197860	150	150	Class B	1 / Pack
197861	200	200	Class B	1 / Pack
Class C Photoluminescent Polyester				
197862	100	100	Class C	1 / Pack
197863	150	150	Class C	1 / Pack
197864	200	200	Class C	1 / Pack
Class B Photoluminescent Polypropylene				
197865	100	100	Class B	1 / Pack
197866	150	150	Class B	1 / Pack
197867	200	200	Class B	1 / Pack
Class C Photoluminescent Polypropylene				
197868	100	100	Class C	1 / Pack
197869	150	150	Class C	1 / Pack
197870	200	200	Class C	1 / Pack
Class C Photoluminescent Aluminium				
197871	100	100	Class C	1 / Pack
197872	150	150	Class C	1 / Pack
197873	200	200	Class C	1 / Pack



Bi-directional

BI-DIRECTIONAL SIGNS

Order Ref.	Width (mm)	Height (mm)	Layout	Total Qty/ Pack
Polyvinylchloride				
197857	151	151	Bi-directional	1 / Pack
197858	151	151	Panoramic	1 / Pack



Panoramic



Bi-directional

BI-DIRECTIONAL PHOTOLUMINESCENT SIGNS

Order Ref.	Width (mm)	Height (mm)	Layout	Class	Total Qty/ Pack
Class B Photoluminescent Polyvinylchloride					
197874	151	151	Bi-directional	Class B	1 / Pack
197875	151	151	Panoramic	Class B	1 / Pack
Class C Photoluminescent Polyvinylchloride					
197876	151	151	Bi-directional	Class C	1 / Pack
197877	151	151	Panoramic	Class C	1 / Pack



Panoramic

BRADY
Customise-it

See page 196 to order your custom-made signs.



For all material properties and applications, see pages 4-5

Complies with EN ISO 7010

FO08 : FIXED FIRE EXTINGUISHING BATTERY

A battery of fire extinguishers provide a powerful fire-fighting capacity in areas such as archive rooms. We recommend that these signs are accompanied by warning signs of asphyxiation when the systems are operated (see W041 page 106).



SIGNS

Order Ref.	Width (mm)	Height (mm)	Total Qty/Pack
Laminated Polyester			
135856	100	100	1 / Pack
135857	148	148	1 / Pack
135858	200	200	1 / Pack
Polypropylene			
135850	100	100	1 / Pack
135851	148	148	1 / Pack
135852	200	200	1 / Pack
Aluminium			
135853	100	100	1 / Pack
135854	150	150	1 / Pack
135855	200	200	1 / Pack



PHOTOLUMINESCENT SIGNS

Order Ref.	Width (mm)	Height (mm)	Class	Total Qty/Pack
Class B Photoluminescent Polyester				
135865	100	100	Class B	1 / Pack
135866	150	150	Class B	1 / Pack
135867	200	200	Class B	1 / Pack
Class C Photoluminescent Polyester				
135874	100	100	Class C	1 / Pack
135875	150	150	Class C	1 / Pack
135876	200	200	Class C	1 / Pack
Class B Photoluminescent Polypropylene				
135859	100	100	Class B	1 / Pack
135860	150	150	Class B	1 / Pack
135861	200	200	Class B	1 / Pack
Class C Photoluminescent Polypropylene				
135868	100	100	Class C	1 / Pack
135869	150	150	Class C	1 / Pack
135870	200	200	Class C	1 / Pack
Class C Photoluminescent Aluminium				
135871	100	100	Class C	1 / Pack
135872	150	150	Class C	1 / Pack
135873	200	200	Class C	1 / Pack



Bi-directional



Panoramic

BI-DIRECTIONAL SIGNS

Order Ref.	Width (mm)	Height (mm)	Layout	Total Qty/Pack
Polyvinylchloride				
135878	151	151	Bi-directional	1 / Pack
135877	151	151	Panoramic	1 / Pack



Bi-directional



Panoramic

BI-DIRECTIONAL PHOTOLUMINESCENT SIGNS

Order Ref.	Width (mm)	Height (mm)	Layout	Class	Total Qty/Pack
Class B Photoluminescent Polyvinylchloride					
135880	151	151	Bi-directional	Class B	1 / Pack
135879	151	151	Panoramic	Class B	1 / Pack
Class C Photoluminescent Polyvinylchloride					
135882	151	151	Bi-directional	Class C	1 / Pack
135881	151	151	Panoramic	Class C	1 / Pack

Complies with EN ISO 7010

FO09 : WHEELED FIRE EXTINGUISHER

The wheeled fire extinguisher can be easily transported to the place of the fire.



SIGNS

Order Ref.	Width (mm)	Height (mm)	Total Qty/Pack
Laminated Polyester			
135889	100	100	1 / Pack
135890	148	148	1 / Pack
135891	200	200	1 / Pack
Polypropylene			
135883	100	100	1 / Pack
135884	148	148	1 / Pack
135885	200	200	1 / Pack
Aluminium			
135886	100	100	1 / Pack
135887	150	150	1 / Pack
135888	200	200	1 / Pack



PHOTOLUMINESCENT SIGNS

Order Ref.	Width (mm)	Height (mm)	Class	Total Qty/Pack
Class B Photoluminescent Polyester				
135898	100	100	Class B	1 / Pack
135899	150	150	Class B	1 / Pack
135900	200	200	Class B	1 / Pack
Class C Photoluminescent Polyester				
135907	100	100	Class C	1 / Pack
135908	150	150	Class C	1 / Pack
135909	200	200	Class C	1 / Pack
Class B Photoluminescent Polypropylene				
135892	100	100	Class B	1 / Pack
135893	150	150	Class B	1 / Pack
135894	200	200	Class B	1 / Pack
Class C Photoluminescent Polypropylene				
135901	100	100	Class C	1 / Pack
135902	150	150	Class C	1 / Pack
135903	200	200	Class C	1 / Pack
Class C Photoluminescent Aluminium				
135904	100	100	Class C	1 / Pack
135905	150	150	Class C	1 / Pack
135906	200	200	Class C	1 / Pack



Bi-directional



Panoramic

BI-DIRECTIONAL SIGNS

Order Ref.	Width (mm)	Height (mm)	Layout	Total Qty/Pack
Polyvinylchloride				
135911	151	151	Bi-directional	1 / Pack
135910	151	151	Panoramic	1 / Pack



Bi-directional



Panoramic

BI-DIRECTIONAL PHOTOLUMINESCENT SIGNS

Order Ref.	Width (mm)	Height (mm)	Layout	Class	Total Qty/Pack
Class B Photoluminescent Polyvinylchloride					
135913	151	151	Bi-directional	Class B	1 / Pack
135912	151	151	Panoramic	Class B	1 / Pack
Class C Photoluminescent Polyvinylchloride					
135915	151	151	Bi-directional	Class C	1 / Pack
135914	151	151	Panoramic	Class C	1 / Pack



F010 : PORTABLE FOAM APPLICATOR UNIT

Foam extinguishers contain an emulsifier which turns into foam on contact with water and when being sprayed in combination with air. These extinguishers are suitable for class B fires, less so for class A fires.



SIGNS

Order Ref.	Width (mm)	Height (mm)	Total Qty/Pack
Laminated Polyester			
135922	100	100	1 / Pack
135923	148	148	1 / Pack
135924	200	200	1 / Pack
Polypropylene			
135916	100	100	1 / Pack
135917	148	148	1 / Pack
135918	200	200	1 / Pack
Aluminium			
135919	100	100	1 / Pack
135920	150	150	1 / Pack
135921	200	200	1 / Pack



PHOTOLUMINESCENT SIGNS

Order Ref.	Width (mm)	Height (mm)	Class	Total Qty/Pack
Class B Photoluminescent Polyester				
135931	100	100	Class B	1 / Pack
135932	150	150	Class B	1 / Pack
135933	200	200	Class B	1 / Pack
Class C Photoluminescent Polyester				
135940	100	100	Class C	1 / Pack
135941	150	150	Class C	1 / Pack
135942	200	200	Class C	1 / Pack
Class B Photoluminescent Polypropylene				
135925	100	100	Class B	1 / Pack
135926	150	150	Class B	1 / Pack
135927	200	200	Class B	1 / Pack
Class C Photoluminescent Polypropylene				
135934	100	100	Class C	1 / Pack
135935	150	150	Class C	1 / Pack
135936	200	200	Class C	1 / Pack
Class C Photoluminescent Aluminium				
135937	100	100	Class C	1 / Pack
135938	150	150	Class C	1 / Pack
135939	200	200	Class C	1 / Pack



Bi-directional



Panoramic

BI-DIRECTIONAL SIGNS

Order Ref.	Width (mm)	Height (mm)	Layout	Total Qty/Pack
Polyvinylchloride				
135944	151	151	Bi-directional	1 / Pack
135943	151	151	Panoramic	1 / Pack



Bi-directional



Panoramic

BI-DIRECTIONAL PHOTOLUMINESCENT SIGNS

Order Ref.	Width (mm)	Height (mm)	Layout	Class	Total Qty/Pack
Class B Photoluminescent Polyvinylchloride					
135946	151	151	Bi-directional	Class B	1 / Pack
135945	151	151	Panoramic	Class B	1 / Pack
Class C Photoluminescent Polyvinylchloride					
135948	151	151	Bi-directional	Class C	1 / Pack
135947	151	151	Panoramic	Class C	1 / Pack



F011 : WATER FOG APPLICATOR

This type of extinguisher is the minimum required by fire regulations. The water smothers the fire, through the water and the steam it creates, by cooling the material in combustion and limiting the spread of fire.



SIGNS

Order Ref.	Width (mm)	Height (mm)	Total Qty/Pack
Laminated Polyester			
135955	100	100	1 / Pack
135956	148	148	1 / Pack
135957	200	200	1 / Pack
Polypropylene			
135949	100	100	1 / Pack
135950	148	148	1 / Pack
135951	200	200	1 / Pack
Aluminium			
135952	100	100	1 / Pack
135953	150	150	1 / Pack
135954	200	200	1 / Pack



PHOTOLUMINESCENT SIGNS

Order Ref.	Width (mm)	Height (mm)	Class	Total Qty/Pack
Class B Photoluminescent Polyester				
135964	100	100	Class B	1 / Pack
135965	150	150	Class B	1 / Pack
135966	200	200	Class B	1 / Pack
Class C Photoluminescent Polyester				
135973	100	100	Class C	1 / Pack
135974	150	150	Class C	1 / Pack
135975	200	200	Class C	1 / Pack
Class B Photoluminescent Polypropylene				
135958	100	100	Class B	1 / Pack
135959	150	150	Class B	1 / Pack
135960	200	200	Class B	1 / Pack
Class C Photoluminescent Polypropylene				
135967	100	100	Class C	1 / Pack
135968	150	150	Class C	1 / Pack
135969	200	200	Class C	1 / Pack
Class C Photoluminescent Aluminium				
135970	100	100	Class C	1 / Pack
135971	150	150	Class C	1 / Pack
135972	200	200	Class C	1 / Pack



Bi-directional



Panoramic

BI-DIRECTIONAL SIGNS

Order Ref.	Width (mm)	Height (mm)	Layout	Total Qty/Pack
Polyvinylchloride				
135977	151	151	Bi-directional	1 / Pack
135976	151	151	Panoramic	1 / Pack



Bi-directional



Panoramic

BI-DIRECTIONAL PHOTOLUMINESCENT SIGNS

Order Ref.	Width (mm)	Height (mm)	Layout	Class	Total Qty/Pack
Class B Photoluminescent Polyvinylchloride					
135979	151	151	Bi-directional	Class B	1 / Pack
135978	151	151	Panoramic	Class B	1 / Pack
Class C Photoluminescent Polyvinylchloride					
135981	151	151	Bi-directional	Class C	1 / Pack
135980	151	151	Panoramic	Class C	1 / Pack

Complies with EN ISO 7010

F012 : FIXED FIRE EXTINGUISHER INSTALLATION

The fixed installation is generally triggered automatically to protect an area or a machine as soon as a fire is detected.



SIGNS

Order Ref.	Width (mm)	Height (mm)	Total Qty/Pack
Laminated Polyester			
135988	100	100	1 / Pack
135989	148	148	1 / Pack
135990	200	200	1 / Pack
Polypropylene			
135982	100	100	1 / Pack
135983	148	148	1 / Pack
135984	200	200	1 / Pack
Aluminium			
135985	100	100	1 / Pack
135986	150	150	1 / Pack
135987	200	200	1 / Pack



PHOTOLUMINESCENT SIGNS

Order Ref.	Width (mm)	Height (mm)	Class	Total Qty/Pack
Class B Photoluminescent Polyester				
135997	100	100	Class B	1 / Pack
135998	150	150	Class B	1 / Pack
135999	200	200	Class B	1 / Pack
Class C Photoluminescent Polyester				
136006	100	100	Class C	1 / Pack
136007	150	150	Class C	1 / Pack
136008	200	200	Class C	1 / Pack
Class B Photoluminescent Polypropylene				
135991	100	100	Class B	1 / Pack
135992	150	150	Class B	1 / Pack
135993	200	200	Class B	1 / Pack
Class C Photoluminescent Polypropylene				
136000	100	100	Class C	1 / Pack
136001	150	150	Class C	1 / Pack
136002	200	200	Class C	1 / Pack
Class C Photoluminescent Aluminium				
136003	100	100	Class C	1 / Pack
136004	150	150	Class C	1 / Pack
136005	200	200	Class C	1 / Pack



BI-DIRECTIONAL SIGNS

Order Ref.	Width (mm)	Height (mm)	Layout	Total Qty/Pack
Polyvinylchloride				
136010	151	151	Bi-directional	1 / Pack
136009	151	151	Panoramic	1 / Pack



BI-DIRECTIONAL PHOTOLUMINESCENT SIGNS

Order Ref.	Width (mm)	Height (mm)	Layout	Class	Total Qty/Pack
Class B Photoluminescent Polyvinylchloride					
136012	151	151	Bi-directional	Class B	1 / Pack
136011	151	151	Panoramic	Class B	1 / Pack
Class C Photoluminescent Polyvinylchloride					
136014	151	151	Bi-directional	Class C	1 / Pack
136013	151	151	Panoramic	Class C	1 / Pack



Complies with EN ISO 7010

F013 : FIXED FIRE EXTINGUISHER BOTTLE

The fixed fire extinguisher works on the same principle as a "standard fire extinguisher, but it is usually triggered automatically to protect an area or a machine.



SIGNS

Order Ref.	Width (mm)	Height (mm)	Total Qty/Pack
Laminated Polyester			
136021	100	100	1 / Pack
136022	148	148	1 / Pack
136023	200	200	1 / Pack
Polypropylene			
136015	100	100	1 / Pack
136016	148	148	1 / Pack
136017	200	200	1 / Pack
Aluminium			
136018	100	100	1 / Pack
136019	150	150	1 / Pack
136020	200	200	1 / Pack



PHOTOLUMINESCENT SIGNS

Order Ref.	Width (mm)	Height (mm)	Class	Total Qty/Pack
Class B Photoluminescent Polyester				
136030	100	100	Class B	1 / Pack
136031	150	150	Class B	1 / Pack
136032	200	200	Class B	1 / Pack
Class C Photoluminescent Polyester				
136039	100	100	Class C	1 / Pack
136040	150	150	Class C	1 / Pack
136041	200	200	Class C	1 / Pack
Class B Photoluminescent Polypropylene				
136024	100	100	Class B	1 / Pack
136025	150	150	Class B	1 / Pack
136026	200	200	Class B	1 / Pack
Class C Photoluminescent Polypropylene				
136033	100	100	Class C	1 / Pack
136034	150	150	Class C	1 / Pack
136035	200	200	Class C	1 / Pack
Class C Photoluminescent Aluminium				
136036	100	100	Class C	1 / Pack
136037	150	150	Class C	1 / Pack
136038	200	200	Class C	1 / Pack



BI-DIRECTIONAL SIGNS

Order Ref.	Width (mm)	Height (mm)	Layout	Total Qty/Pack
Polyvinylchloride				
136043	151	151	Bi-directional	1 / Pack
136042	151	151	Panoramic	1 / Pack



BI-DIRECTIONAL PHOTOLUMINESCENT SIGNS

Order Ref.	Width (mm)	Height (mm)	Layout	Class	Total Qty/Pack
Class B Photoluminescent Polyvinylchloride					
136045	151	151	Bi-directional	Class B	1 / Pack
136044	151	151	Panoramic	Class B	1 / Pack
Class C Photoluminescent Polyvinylchloride					
136047	151	151	Bi-directional	Class C	1 / Pack
136046	151	151	Panoramic	Class C	1 / Pack





F014 : REMOTE RELEASE STATION

Under certain circumstances or for some installations, a remote release mechanism is necessary. In such cases the location of the control station for this mechanism needs to be clearly indicated.



SIGNS

Order Ref.	Width (mm)	Height (mm)	Total Qty/Pack
Laminated Polyester			
136054	100	100	1 / Pack
136055	148	148	1 / Pack
136056	200	200	1 / Pack
Polypropylene			
136048	100	100	1 / Pack
136049	148	148	1 / Pack
136050	200	200	1 / Pack
Aluminium			
136051	100	100	1 / Pack
136052	150	150	1 / Pack
136053	200	200	1 / Pack



PHOTOLUMINESCENT SIGNS

Order Ref.	Width (mm)	Height (mm)	Class	Total Qty/Pack
Class B Photoluminescent Polyester				
136063	100	100	Class B	1 / Pack
136064	150	150	Class B	1 / Pack
136065	200	200	Class B	1 / Pack
Class C Photoluminescent Polyester				
136072	100	100	Class C	1 / Pack
136073	150	150	Class C	1 / Pack
136074	200	200	Class C	1 / Pack
Class B Photoluminescent Polypropylene				
136057	100	100	Class B	1 / Pack
136058	150	150	Class B	1 / Pack
136059	200	200	Class B	1 / Pack
Class C Photoluminescent Polypropylene				
136066	100	100	Class C	1 / Pack
136067	150	150	Class C	1 / Pack
136068	200	200	Class C	1 / Pack
Class C Photoluminescent Aluminium				
136069	100	100	Class C	1 / Pack
136070	150	150	Class C	1 / Pack
136071	200	200	Class C	1 / Pack



Bi-directional



Panoramic

BI-DIRECTIONAL SIGNS

Order Ref.	Width (mm)	Height (mm)	Layout	Total Qty/Pack
Polyvinylchloride				
136076	151	151	Bi-directional	1 / Pack
136075	151	151	Panoramic	1 / Pack



Bi-directional



Panoramic

BI-DIRECTIONAL PHOTOLUMINESCENT SIGNS

Order Ref.	Width (mm)	Height (mm)	Layout	Class	Total Qty/Pack
Class B Photoluminescent Polyvinylchloride					
136078	151	151	Bi-directional	Class B	1 / Pack
136077	151	151	Panoramic	Class B	1 / Pack
Class C Photoluminescent Polyvinylchloride					
136080	151	151	Bi-directional	Class C	1 / Pack
136079	151	151	Panoramic	Class C	1 / Pack



F015 : FIRE MONITOR

A fire monitor or water cannon is an aimable controllable high-capacity water jet. They are generally most effective when used at a few dozen metres away, and require a considerable reservoir. Water cannons are used to extinguish fires, and by riot police to keep large crowds under control. Most water cannons are an acceptable replacement for a fire hose.



SIGNS

Order Ref.	Width (mm)	Height (mm)	Total Qty/Pack
Laminated Polyester			
136087	100	100	1 / Pack
136088	148	148	1 / Pack
136089	200	200	1 / Pack
Polypropylene			
136081	100	100	1 / Pack
136082	148	148	1 / Pack
136083	200	200	1 / Pack
Aluminium			
136084	100	100	1 / Pack
136085	150	150	1 / Pack
136086	200	200	1 / Pack



PHOTOLUMINESCENT SIGNS

Order Ref.	Width (mm)	Height (mm)	Class	Total Qty/Pack
Class B Photoluminescent Polyester				
136096	100	100	Class B	1 / Pack
136097	150	150	Class B	1 / Pack
136098	200	200	Class B	1 / Pack
Class C Photoluminescent Polyester				
136105	100	100	Class C	1 / Pack
136106	150	150	Class C	1 / Pack
136107	200	200	Class C	1 / Pack
Class B Photoluminescent Polypropylene				
136090	100	100	Class B	1 / Pack
136091	150	150	Class B	1 / Pack
136092	200	200	Class B	1 / Pack
Class C Photoluminescent Polypropylene				
136099	100	100	Class C	1 / Pack
136100	150	150	Class C	1 / Pack
136101	200	200	Class C	1 / Pack
Class C Photoluminescent Aluminium				
136102	100	100	Class C	1 / Pack
136103	150	150	Class C	1 / Pack
136104	200	200	Class C	1 / Pack



Bi-directional



Panoramic

BI-DIRECTIONAL SIGNS

Order Ref.	Width (mm)	Height (mm)	Layout	Total Qty/Pack
Polyvinylchloride				
136109	151	151	Bi-directional	1 / Pack
136108	151	151	Panoramic	1 / Pack



Bi-directional



Panoramic

BI-DIRECTIONAL PHOTOLUMINESCENT SIGNS

Order Ref.	Width (mm)	Height (mm)	Layout	Class	Total Qty/Pack
Class B Photoluminescent Polyvinylchloride					
136111	151	151	Bi-directional	Class B	1 / Pack
136110	151	151	Panoramic	Class B	1 / Pack
Class C Photoluminescent Polyvinylchloride					
136113	151	151	Bi-directional	Class C	1 / Pack
136112	151	151	Panoramic	Class C	1 / Pack

Complies with EN ISO 7010

F016 : FIRE BLANKET

Indicates the location of a fire blanket. The fire blanket enables a nascent fire to be smothered, whether on a person or an object. It must be used in addition to other equipment such as smoke detectors.



SIGNS

Order Ref.	Width (mm)	Height (mm)	Total Qty/ Pack
Laminated Polyester			
195692	148	148	1 / Pack
195698	200	200	1 / Pack
Polypropylene			
195693	148	148	1 / Pack
195699	200	200	1 / Pack
Aluminium			
195704	100	100	1 / Pack
195705	200	200	1 / Pack
195706	315	315	1 / Pack

FLOOR MARKING

Order Ref.	Width (mm)	Height (mm)	Total Qty/ Pack
Anti-skid Laminated Polyester			
195719	500	500	1 / Pack

MINI-PICTOGRAMS

Order Ref.	Width (mm)	Height (mm)	Total Qty/ Pack
Vinyl			
195720	10	10	96 / Pack



PHOTOLUMINESCENT SIGNS

Order Ref.	Width (mm)	Height (mm)	Total Qty/ Pack
Class B Photoluminescent Polyester			
195694	150	150	1 / Pack
195700	200	200	1 / Pack
Class C Photoluminescent Polyester			
195695	150	150	1 / Pack
195701	200	200	1 / Pack
Class B Photoluminescent Polypropylene			
195696	150	150	1 / Pack
195702	200	200	1 / Pack
Class C Photoluminescent Polypropylene			
195697	150	150	1 / Pack
195703	200	200	1 / Pack



PICTOGRAMS ON ROLLS

Order Ref.	Width (mm)	Height (mm)	Total Qty/ Pack
Laminated Polyester			
195721	100	100	250 / Roll

BI-DIRECTIONAL SIGNS



Panoramic

Order Ref.	Width (mm)	Height (mm)	Layout	Total Qty/ Pack
Polyvinylchloride				
195707	151	151	Panoramic	1 / Pack
195710	203	203	Panoramic	1 / Pack
195713	253	253	Panoramic	1 / Pack
195716	318	318	Panoramic	1 / Pack

BI-DIRECTIONAL PHOTOLUMINESCENT SIGNS



Panoramic

Order Ref.	Width (mm)	Height (mm)	Layout	Class	Total Qty/ Pack
Class B Photoluminescent Polyvinylchloride					
195708	151	151	Panoramic	Class B	1 / Pack
195711	203	203	Panoramic	Class B	1 / Pack
195714	253	253	Panoramic	Class B	1 / Pack
195717	318	318	Panoramic	Class B	1 / Pack
Class C Photoluminescent Polyvinylchloride					
195709	151	151	Panoramic	Class C	1 / Pack
195712	203	203	Panoramic	Class C	1 / Pack
195715	253	253	Panoramic	Class C	1 / Pack
195718	318	318	Panoramic	Class C	1 / Pack

SIGNS WITH TEXT



Order Ref.	Width (mm)	Height (mm)	Layout	Legend	Total Qty/Pack
Polypropylene					
195727	450	150	Landscape	Fire blanket	1 Sign(s) / Pack
195726	148	210	Portrait	Fire blanket	1 Sign(s) / Pack
195725	210	297	Portrait	Fire blanket	1 Sign(s) / Pack
Laminated Polyester					
195724	450	150	Landscape	Fire blanket	1 Sign(s) / Pack
195723	148	210	Portrait	Fire blanket	1 Sign(s) / Pack
195722	210	297	Portrait	Fire blanket	1 Sign(s) / Pack

i For all material properties and applications, see pages 4-5

BRADY Customise-it See page 196 to order your custom-made signs.



A045R : DIRECTION ARROW 45°, TOP RIGHT CORNER

Red directional arrows can be used to guide towards fire-fighting equipment. These can be turned to indicate the desired direction. Must be used in combination with another safety sign.



SIGNS

Order Ref.	Width (mm)	Height (mm)	Total Qty/ Pack
Laminated Polyester			
830821	100	100	1 / Pack
830822	148	148	1 / Pack
830823	200	200	1 / Pack
830824	250	250	1 / Pack
830826	315	315	1 / Pack
830827	400	400	1 / Pack
Polypropylene			
830829	100	100	1 / Pack
830830	148	148	1 / Pack
830831	200	200	1 / Pack
830832	250	250	1 / Pack
830834	315	315	1 / Pack
830835	400	400	1 / Pack
Aluminium			
830836	100	100	1 / Pack
830837	200	200	1 / Pack

FLOOR MARKING

Order Ref.	Width (mm)	Height (mm)	Total Qty/ Pack
Anti-skid Laminated Polyester			
830828	500	500	1 / Pack

MINI-PICTOGRAMS

Order Ref.	Width (mm)	Height (mm)	Total Qty/ Pack
Vinyl			
830819	10	10	96 / Pack



Bi-directional



BI-DIRECTIONAL SIGNS *

Order Ref.	Width (mm)	Height (mm)	Layout	Total Qty/ Pack
Polyvinylchloride				
830838	151	151	Bi-directional	1 / Pack
830839	203	203	Bi-directional	1 / Pack
830840	253	253	Bi-directional	1 / Pack
830841	318	318	Bi-directional	1 / Pack

*Direction of rotation limited by the lateral fixing

PHOTOLUMINESCENT SIGNS

Order Ref.	Width (mm)	Height (mm)	Class	Total Qty/ Pack
Class C Photoluminescent Polyester				
835007	150	150	Class C	1 / Pack
835008	200	200	Class C	1 / Pack
Class C Photoluminescent Aluminium				
835005	150	150	Class C	1 / Pack
835006	200	200	Class C	1 / Pack



PICTOGRAMS ON ROLLS

Order Ref.	Width (mm)	Height (mm)	Total Qty/ Pack
Laminated Polyester			
830820	100	100	250 / Roll



A090R : DIRECTION ARROW 90°, TO THE RIGHT

Red directional arrows can be used to guide towards fire-fighting equipment. These can be turned to indicate the desired direction. Must be used in combination with another safety sign.



SIGNS

Order Ref.	Width (mm)	Height (mm)	Total Qty/ Pack
Laminated Polyester			
830794	100	100	1 / Pack
830795	148	148	1 / Pack
830796	200	200	1 / Pack
830797	250	250	1 / Pack
830799	315	315	1 / Pack
830800	400	400	1 / Pack
Polypropylene			
830802	100	100	1 / Pack
830803	148	148	1 / Pack
830804	200	200	1 / Pack
830805	250	250	1 / Pack
830807	315	315	1 / Pack
830808	400	400	1 / Pack
Aluminium			
830809	100	100	1 / Pack
830810	200	200	1 / Pack

FLOOR MARKING

Order Ref.	Width (mm)	Height (mm)	Total Qty/ Pack
Anti-skid Laminated Polyester			
830801	500	500	1 / Pack

MINI-PICTOGRAMS

Order Ref.	Width (mm)	Height (mm)	Total Qty/ Pack
Vinyl			
830792	10	10	96 / Pack



Bi-directional



BI-DIRECTIONAL SIGNS *

Order Ref.	Width (mm)	Height (mm)	Layout	Total Qty/ Pack
Polyvinylchloride				
830811	151	151	Bi-directional	1 / Pack
830812	203	203	Bi-directional	1 / Pack
830813	253	253	Bi-directional	1 / Pack
830814	318	318	Bi-directional	1 / Pack

*Direction of rotation limited by the lateral fixing

PHOTOLUMINESCENT SIGNS

Order Ref.	Width (mm)	Height (mm)	Class	Total Qty/ Pack
Class B Photoluminescent Polyester				
836674	200	200	Class B	1 / Pack
Class B Photoluminescent Polypropylene				
836669	150	150	Class B	1 / Pack
836670	200	200	Class B	1 / Pack
836673	300	300	Class B	1 / Pack



PICTOGRAMS ON ROLLS

Order Ref.	Width (mm)	Height (mm)	Total Qty/ Pack
Laminated Polyester			
830793	100	100	250 / Roll

EXTINGUISHER CODE SIGNS

- Position the signs near to all your fire extinguisher stations to help staff understand which is the correct extinguisher to use.
- Comply with the Health & Safety (Safety Signs & Signals) Regulations 1996, BS EN3 Regulations & BS5499 Safety Sign Standards

KNOW YOUR FIRE EXTINGUISHER COLOUR CODE

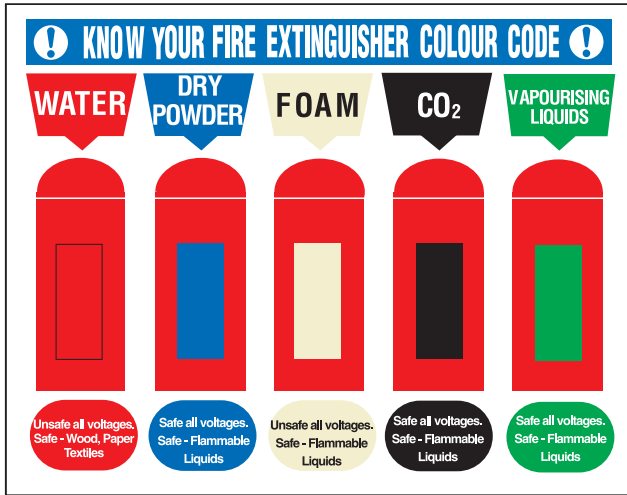

Order Ref.	Width (mm)	Height (mm)	Total Qty/ Pack
Self-adhesive Vinyl			
702051	300	250	1 / Pack
702053	450	300	1 / Pack
Rigid Plastic			
702050	300	250	1 / Pack
702052	450	300	1 / Pack

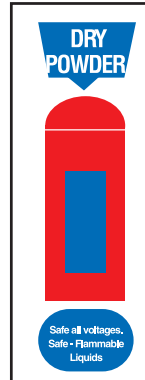

DRY POWDER

Safe - all voltages and flammable liquids.

Order Ref.	Width (mm)	Height (mm)	Total Qty/ Pack
Self-adhesive Vinyl			
702057	100	300	1 / Pack
Rigid Plastic			
702056	100	300	1 / Pack

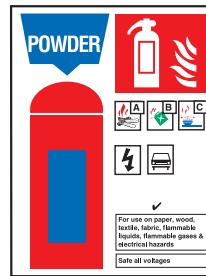

POWDER CLASS A B C

For use on paper, wood, textile, fabric, flammable liquids, flammable gases & electrical hazards Safe all voltages.

Order Ref.	Width (mm)	Height (mm)	Total Qty/ Pack
Self-adhesive Vinyl			
701354	148	210	1 / Pack
702232	210	297	1 / Pack
Rigid Plastic			
701353	148	210	1 / Pack
Polypropylene			
702231	210	297	1 / Pack

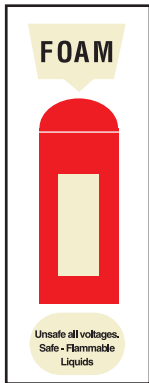

FOAM

Safe - flammable liquids.

Order Ref.	Width (mm)	Height (mm)	Total Qty/ Pack
Self-adhesive Vinyl			
702059	100	300	1 / Pack
Rigid Plastic			
702058	100	300	1 / Pack

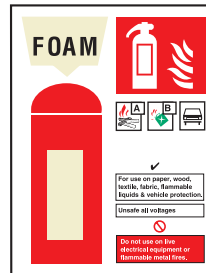

FOAM CLASS A B

For use on paper, wood, textile, fabric, flammable liquids & vehicle protection. Unsafe all voltages. Do not use on live electrical equipment or flammable metal fires.

Order Ref.	Width (mm)	Height (mm)	Total Qty/ Pack
Self-adhesive Vinyl			
702236	148	210	1 / Pack
702234	210	297	1 / Pack
Rigid Plastic			
702235	148	210	1 / Pack
702233	210	297	1 / Pack

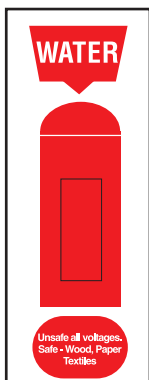

WATER

Unsafe all voltages.

Safe - wood, paper and textile.

Order Ref.	Width (mm)	Height (mm)	Total Qty/ Pack
Self-adhesive Vinyl			
702055	100	300	1 / Pack
Rigid Plastic			
702054	100	300	1 / Pack



WATER CLASS A

For use on paper, wood, textile & fabric. Unsafe all voltages. Do not use on flammable liquid, live electrical equipment or flammable metal fires.

Order Ref.	Width (mm)	Height (mm)	Total Qty/ Pack
Self-adhesive Vinyl			
701366	148	210	1 / Pack
701312	210	297	1 / Pack
Rigid Plastic			
701365	148	210	1 / Pack
701311	210	297	1 / Pack

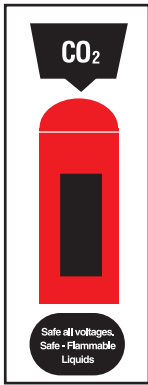

CO2

Safe - all voltage and flammable liquids.

Order Ref.	Width (mm)	Height (mm)	Total Qty/ Pack
Self-adhesive Vinyl			
702061	100	300	1 / Pack
Rigid Plastic			
702060	100	300	1 / Pack

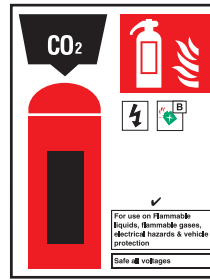

CO2 CLASS B

For use on flammable liquids, flammable gases, electrical hazards & vehicle protection. Safe all voltages.

Order Ref.	Width (mm)	Height (mm)	Total Qty/ Pack
Self-adhesive Vinyl			
701356	148	210	1 / Pack
701298	210	297	1 / Pack
Rigid Plastic			
701355	148	210	1 / Pack
701297	210	297	1 / Pack

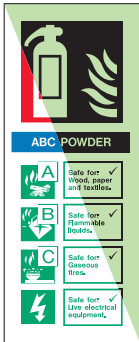

CLASS ABC POWDER

Order Ref.	Width (mm)	Height (mm)	Total Qty/ Pack
Rigid Plastic			
702046	80	200	1 / Piece



FOAM SPRAY

Order Ref.	Width (mm)	Height (mm)	Total Qty/ Pack
Rigid Plastic			
702044	80	200	1 / Piece



WATER

Order Ref.	Width (mm)	Height (mm)	Total Qty/ Pack
Rigid Plastic			
702042	80	200	1 / Piece

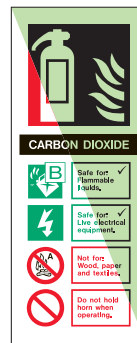

CARBON DIOXIDE

Order Ref.	Width (mm)	Height (mm)	Total Qty/ Pack
Rigid Plastic			
702045	80	200	1 / Piece



FIRE HOSE REEL

Order Ref.	Width (mm)	Height (mm)	Total Qty/ Pack
Rigid Plastic			
702043	80	200	1 / Piece

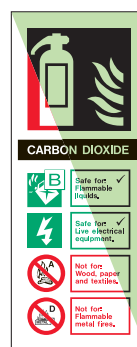

CARBON DIOXIDE

Order Ref.	Width (mm)	Height (mm)	Total Qty/ Pack
Rigid Plastic			
702262	80	200	1 / Piece

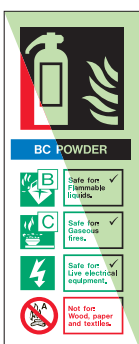

CLASS B C POWDER

Order Ref.	Width (mm)	Height (mm)	Total Qty/ Pack
Rigid Plastic			
702263	80	200	1 / Piece

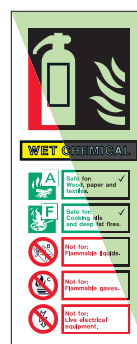

WET CHEMICAL

Order Ref.	Width (mm)	Height (mm)	Total Qty/ Pack
Rigid Plastic			
702264	80	200	1 / Piece



Brady offers a wide range of photoluminescent products. These indicate danger zones, even in complete darkness. In case of an emergency, these products will help your employees to find their way out of a dark room.

Minimum Luminance

Class	After 10 minutes	After 60 minutes
A	23 mcd/m ²	3 mcd/m ²
B	50 mcd/m ²	7 mcd/m ²
C	140 mcd/m ²	20 mcd/m ²
D	260 mcd/m ²	35 mcd/m ²

mcd = Millicandela



PHOTOLUMINESCENT FLOOR MARKING ARROWS (SELF-ADHESIVE)

Order Ref.	Diameter (mm)	Description	Total Qty/Pack	Class
263387	95.00	Photoluminescent Floor Marking Arrows (self-adhesive)	10 Piece(s) / Pack	Class A

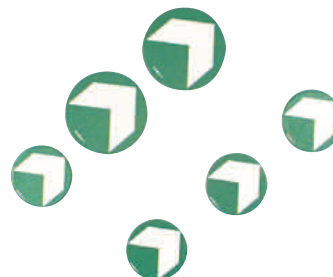

PHOTOLUMINESCENT ARROWS - RECTANGULAR (SELF-ADHESIVE)

Order Ref.	Height (mm)	Width (mm)	Description	Total Qty/Pack	Class
251920	175.00	110.00	Photoluminescent arrow with anti-skid top - Rectangular	10 Piece(s) / Pack	Class A



PHOTOLUMINESCENT ANTI-SKID STRIPS

THESE SELF-ADHESIVE ALUMINIUM ANTI-SKID STRIPS ARE IDEAL FOR MARKING THE EDGES OF STAIRS AND DOORWAYS. THEY ARE AVAILABLE IN A STANDARD LUMINOUS INTENSITY VERSION AND A HIGH LUMINOUS INTENSITY VERSION.

Article No.	Colour	Width (mm)	Length (m)	Packaging	Class
Photoluminescent Anti-skid Strips - Aluminium High intensity / Striped					
251930	Black/Photoluminescent	30.00	0.80 m	1	Class C
251932	Black/Photoluminescent	50.00	0.80 m	1	Class C
Photoluminescent Anti-skid Strips - Aluminium High intensity					
251926	Photoluminescent	30.00	0.80 m	1	Class C
251928	Photoluminescent	50.00	0.80 m	1	Class C
Photoluminescent Anti-skid Strips - Aluminium Standard intensity					
251925	Photoluminescent	30.00	0.80 m	1	Class B

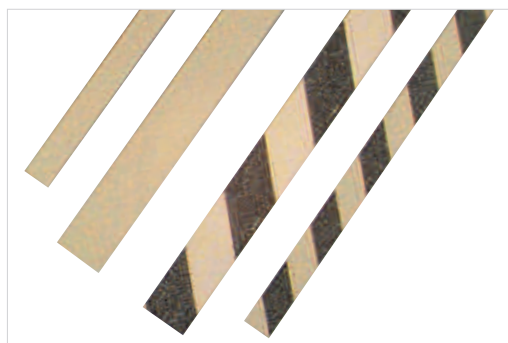

NITE-GLO

XTRA-GLO

Emergency occur every day on ferries, tankers, at airports and on rigs. Emergency situations are unpredictable, so a quick and efficient evacuation is essential for both staff and visitors. For this reason, clear and flexible safety signage is vital.

Nite Glo™ and Xtra Glo™ are effective products designed to offer emergency indications in the most effective way possible under the most difficult circumstances.

The range of lighting indicators is designed in self-adhesive laminated polyester (flexible material) and in high-quality rigid polypropylene. It may be used both outdoors and indoors. Glow-in-the-dark signs require no upkeep, have zero maintenance cost and an unlimited lifetime.





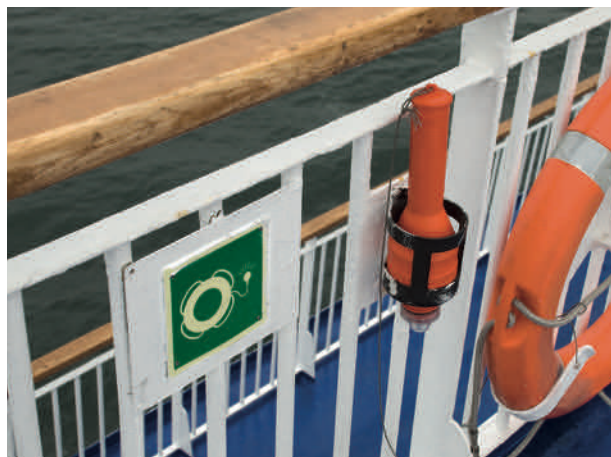









See page 202 for more information and our full range of maritime safety signs.



Danger

Symbol	Description	Page
	W001 : Warning; General sign	71
	W002 : Warning; Explosive material	72
	W003 : Warning; Radioactive material or ionizing radiation	73
	W004 : Warning; laser beam	74
	W005 : Warning; Non-ionizing radiation	75
	W006 : Warning; Magnetic field	76
	W007 : Warning; Floor level obstacle	77
	W008 : Warning; Drop (fall)	78
	W009 : Warning; Biological hazard	79
	W010 : Warning; Low temperature/ freezing conditions	80
	W011 : Warning; Slippery surface	81
	W012 : Warning; Electricity	82
	W013 : Warning; Guard dog	84
	W014 : Warning; Fork lift trucks and other industrial vehicles	85
	W015 : Warning; Overhead load	86
	W016 : Warning; Toxic material	87
	W017 : Warning; Hot surface	88
	W018 : Warning; Automatic start-up	89
	W019 : Warning; Crushing	90
	W020 : Warning; Overhead obstacles	91
	W021 : Warning; Risk of fire/ Flammable materials	92

Symbol	Description	Page
	W022 : Warning; Sharp elements	93
	W023 : Warning; Corrosive substance	94
	W024 : Warning; Crushing of hands	95
	W025 : Warning; Counter rotating rollers	96
	W026 : Warning; Battery charging	97
	W027 : Warning; Optical radiation	98
	W028 : Warning; Oxidizing substance	99
	W029 : Warning; Pressurised cylinder	100
	W030 : Warning; Hand crushing between press brake tool	101
	W031 : Warning; Hand crushing between press brake tool	101
	W032 : Warning; Rapid movement of workpiece in press brake	102
	W033 : Warning; Barbed wire	102
	W034 : Warning; Bull	103
	W035 : Warning; Falling objects	103
	W036 : Warning; Fragile roof	104
	W037 : Warning; Run over by remote operator controlled machine	104
	W038 : Warning; Sudden loud noise	105
	W039 : Warning; Falling ice	105
	W040 : Warning; Roof avalance	106
	W041 : Warning; Asphyxiating atmosphere	106
	W042 : Warning; Arc flash	107

Symbol	Description	Page
	PIC 2516 (PIC 313) : Warning; Explosive atmosphere	108
	PIC 321 : Warning; Toxic Irritant Health hazard	108
	PIC 327 : Warning; Electrostatic	109
	PIC 329 : Warning; Earth	109

Complies with EN ISO 7010

W001 : WARNING; GENERAL SIGN

The W001 danger symbol is the most basic and general. For this reason, it is essential to position it with a legend clarifying the danger. It is advisable to indicate a danger, the action to avoid and the appropriate means of protection around a machine.



SIGNS

Order Ref.	Width (mm)	Height (mm)	Total Qty/ Pack
Laminated Polyester			
826613	50	43	7 / Pack
826615	100	87	3 / Pack
826616	200	173	1 / Pack
826617	315	273	1 / Pack
Polypropylene			
826619	100	87	1 / Pack
826620	200	173	1 / Pack
826621	315	273	1 / Pack
Aluminium			
826622	100	87	1 / Pack
826623	200	173	1 / Pack
826624	315	273	1 / Pack



PHOTOLUMINESCENT SIGNS

Order Ref.	Width (mm)	Height (mm)	Class	Total Qty/ Pack
Class B Photoluminescent Polyester				
836767	150	130	Class B	1 / Pack
Class B Photoluminescent Polypropylene				
836766	150	130	Class B	1 / Pack



PICTOGRAMS ON ROLLS

Order Ref.	Width (mm)	Height (mm)	Total Qty/ Pack
Laminated Polyester			
826610	25	22	250 / Roll
826612	50	43	250 / Roll
826614	100	87	250 / Roll

FLOOR MARKING

Order Ref.	Width (mm)	Height (mm)	Total Qty/ Pack
Anti-skid Laminated Polyester			
826618	500	433	1 / Pack

MINI-PICTOGRAMS

Order Ref.	Width (mm)	Height (mm)	Total Qty/ Pack
Laminated Polyester			
139003	10	9	54 / Pack
139004	20	17	15 / Pack
826611	25	22	13 / Pack
Vinyl			
826609	15	13	54 / Pack



The W001 danger symbol must be positioned with a legend clarifying the danger.

BRADY
Customise-it

See page 196 to order your custom-made signs.



W002 : WARNING; EXPLOSIVE MATERIAL

Explosive materials must be clearly marked to ensure the necessary steps are taken with regards to the environment, storage and code of conduct.



It is recommended to use CLP sign GHS01 on the packaging of the explosive material (see page 221).



SIGNS

Order Ref.	Width (mm)	Height (mm)	Total Qty/ Pack
Laminated Polyester			
816664	50	43	7 / Pack
816666	100	87	3 / Pack
816667	200	173	1 / Pack
816668	315	273	1 / Pack
Polypropylene			
816670	100	87	1 / Pack
816671	200	173	1 / Pack
816672	315	273	1 / Pack
Aluminium			
816673	100	87	1 / Pack
816674	200	173	1 / Pack
816675	315	273	1 / Pack

FLOOR MARKING

Order Ref.	Width (mm)	Height (mm)	Total Qty/ Pack
Anti-skid Laminated Polyester			
816669	500	433	1 / Pack

MINI-PICTOGRAMS

Order Ref.	Width (mm)	Height (mm)	Total Qty/ Pack
Laminated Polyester			
138995	10	9	54 / Pack
816662	25	22	13 / Pack
Vinyl			
816660	15	13	54 / Pack

SIGNS WITH TEXT



Order Ref.	Width (mm)	Height (mm)	Layout	Legend	Total Qty/ Pack
Laminated Polyester					
816723	150	50	Landscape	Warning; explosive material	1 / Pack
816724	297	74	Landscape	Warning; explosive material	1 / Pack
816726	450	150	Landscape	Warning; explosive material	1 / Pack
816727	600	200	Landscape	Warning; explosive material	1 / Pack
816720	148	210	Portrait	Warning; explosive material	1 / Pack
816721	210	297	Portrait	Warning; explosive material	1 / Pack
816725	297	105	Portrait	Warning; explosive material	1 / Pack
816722	297	420	Portrait	Warning; explosive material	1 / Pack
Polypropylene					
816731	150	50	Landscape	Warning; explosive material	1 / Pack
816732	297	74	Landscape	Warning; explosive material	1 / Pack
816734	450	150	Landscape	Warning; explosive material	1 / Pack
816735	600	200	Landscape	Warning; explosive material	1 / Pack
816728	148	210	Portrait	Warning; explosive material	1 / Pack
816729	210	297	Portrait	Warning; explosive material	1 / Pack
816733	297	105	Portrait	Warning; explosive material	1 / Pack
816730	297	420	Portrait	Warning; explosive material	1 / Pack
Aluminium					
816739	150	50	Landscape	Warning; explosive material	1 / Pack
816741	450	150	Landscape	Warning; explosive material	1 / Pack
816736	148	210	Portrait	Warning; explosive material	1 / Pack
816737	210	297	Portrait	Warning; explosive material	1 / Pack
816740	297	105	Portrait	Warning; explosive material	1 / Pack
816738	297	420	Portrait	Warning; explosive material	1 / Pack



PICTOGRAMS ON ROLLS

Order Ref.	Width (mm)	Height (mm)	Total Qty/Pack
Laminated Polyester			
816661	25	22	250 / Roll
816663	50	43	250 / Roll
816665	100	87	250 / Roll



PHOTOLUMINESCENT SIGNS

Order Ref.	Width (mm)	Height (mm)	Class	Total Qty/ Pack
Class B Photoluminescent Polyester				
836133	150	130	Class B	1 / Pack
Class C Photoluminescent Polyester				
836134	150	130	Class C	1 / Pack
Class B Photoluminescent Polypropylene				
836131	150	130	Class B	1 / Pack
Class C Photoluminescent Polypropylene				
836132	150	130	Class C	1 / Pack
Class C Photoluminescent Aluminium				
836130	150	130	Class C	1 / Pack

i For all material properties and applications, see pages 4-5

BRADY Customise-it See page 196 to order your custom-made signs.

Complies with EN ISO 7010

W003 : WARNING; RADIOACTIVE MATERIAL OR IONIZING RADIATION

The identification of such areas allows the restrictions for some personnel and appropriate protection to be communicated at the same time.



SIGNS

Order Ref.	Width (mm)	Height (mm)	Total Qty/ Pack
Laminated Polyester			
826761	50	43	7 / Pack
826763	100	87	3 / Pack
826764	200	173	1 / Pack
826765	315	273	1 / Pack
Polypropylene			
826767	100	87	1 / Pack
826768	200	173	1 / Pack
826769	315	273	1 / Pack
Aluminium			
826770	100	87	1 / Pack
826771	200	173	1 / Pack
826772	315	273	1 / Pack

FLOOR MARKING

Order Ref.	Width (mm)	Height (mm)	Total Qty/ Pack
Anti-skid Laminated Polyester			
826766	500	433	1 / Pack

MINI-PICTOGRAMS

Order Ref.	Width (mm)	Height (mm)	Total Qty/ Pack
Laminated Polyester			
138998	10	9	54 / Pack
826759	25	22	13 / Pack
Vinyl			
826757	15	13	54 / Pack



PICTOGRAMS ON ROLLS

Order Ref.	Width (mm)	Height (mm)	Total Qty/ Pack
Laminated Polyester			
826758	25	22	250 / Roll
826760	50	43	250 / Roll
826762	100	87	250 / Roll



PHOTOLUMINESCENT SIGNS

Order Ref.	Width (mm)	Height (mm)	Class	Total Qty/ Pack
Class B Photoluminescent Polyester				
836769	150	130	Class B	1 / Pack
Class B Photoluminescent Polypropylene				
836768	150	130	Class B	1 / Pack

SIGNS WITH TEXT

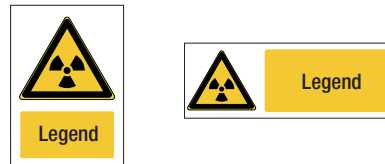

Order Ref.	Width (mm)	Height (mm)	Layout	Legend	Total Qty/ Pack
Laminated Polyester					
826820	150	50	Landscape	Warning; Radioactive material or ionizing radiation	1 / Pack
826821	297	74	Landscape	Warning; Radioactive material or ionizing radiation	1 / Pack
826823	450	150	Landscape	Warning; Radioactive material or ionizing radiation	1 / Pack
826824	600	200	Landscape	Warning; Radioactive material or ionizing radiation	1 / Pack
826817	148	210	Portrait	Warning; Radioactive material or ionizing radiation	1 / Pack
826818	210	297	Portrait	Warning; Radioactive material or ionizing radiation	1 / Pack
826822	297	105	Portrait	Warning; Radioactive material or ionizing radiation	1 / Pack
826819	297	420	Portrait	Warning; Radioactive material or ionizing radiation	1 / Pack
Polypropylene					
826828	150	50	Landscape	Warning; Radioactive material or ionizing radiation	1 / Pack
826829	297	74	Landscape	Warning; Radioactive material or ionizing radiation	1 / Pack
826831	450	150	Landscape	Warning; Radioactive material or ionizing radiation	1 / Pack
826832	600	200	Landscape	Warning; Radioactive material or ionizing radiation	1 / Pack
826825	148	210	Portrait	Warning; Radioactive material or ionizing radiation	1 / Pack
826826	210	297	Portrait	Warning; Radioactive material or ionizing radiation	1 / Pack
826830	297	105	Portrait	Warning; Radioactive material or ionizing radiation	1 / Pack
826827	297	420	Portrait	Warning; Radioactive material or ionizing radiation	1 / Pack
Aluminium					
826836	150	50	Landscape	Warning; Radioactive material or ionizing radiation	1 / Pack
826838	450	150	Landscape	Warning; Radioactive material or ionizing radiation	1 / Pack
826833	148	210	Portrait	Warning; Radioactive material or ionizing radiation	1 / Pack
826834	210	297	Portrait	Warning; Radioactive material or ionizing radiation	1 / Pack
826837	297	105	Portrait	Warning; Radioactive material or ionizing radiation	1 / Pack
826835	297	420	Portrait	Warning; Radioactive material or ionizing radiation	1 / Pack

i For all material properties and applications, see pages 4-5

BRADY Customise-it See page 196 to order your custom-made signs.



W004 : WARNING; LASER BEAM

A laser beam can be dangerous if the necessary protective measures are not taken. Pointing out the danger helps to warn of certain consequences of exposure to it.



SIGNS

Order Ref.	Width (mm)	Height (mm)	Total Qty/ Pack
Laminated Polyester			
826909	50	43	7 / Pack
826911	100	87	3 / Pack
826912	200	173	1 / Pack
826913	315	273	1 / Pack
Polypropylene			
826915	100	87	1 / Pack
826916	200	173	1 / Pack
826917	315	273	1 / Pack
Aluminium			
826918	100	87	1 / Pack
826919	200	173	1 / Pack
826920	315	273	1 / Pack

FLOOR MARKING

Order Ref.	Width (mm)	Height (mm)	Total Qty/ Pack
Anti-skid Laminated Polyester			
826914	500	433	1 / Pack

MINI-PICTOGRAMS

Order Ref.	Width (mm)	Height (mm)	Total Qty/ Pack
Laminated Polyester			
139005	10	9	54 / Pack
139026	20	17	15 / Pack
826907	25	22	13 / Pack
Vinyl			
826905	15	13	54 / Pack

SIGNS WITH TEXT



Order Ref.	Width (mm)	Height (mm)	Layout	Legend	Total Qty/ Pack
Laminated Polyester					
826968	150	50	Landscape	Warning; laser beam	1 / Pack
826969	297	74	Landscape	Warning; laser beam	1 / Pack
826971	450	150	Landscape	Warning; laser beam	1 / Pack
826972	600	200	Landscape	Warning; laser beam	1 / Pack
826965	148	210	Portrait	Warning; laser beam	1 / Pack
826966	210	297	Portrait	Warning; laser beam	1 / Pack
826970	297	105	Portrait	Warning; laser beam	1 / Pack
826967	297	420	Portrait	Warning; laser beam	1 / Pack
Polypropylene					
826976	150	50	Landscape	Warning; laser beam	1 / Pack
826977	297	74	Landscape	Warning; laser beam	1 / Pack
826979	450	150	Landscape	Warning; laser beam	1 / Pack
826980	600	200	Landscape	Warning; laser beam	1 / Pack
826973	148	210	Portrait	Warning; laser beam	1 / Pack
826974	210	297	Portrait	Warning; laser beam	1 / Pack
826978	297	105	Portrait	Warning; laser beam	1 / Pack
826975	297	420	Portrait	Warning; laser beam	1 / Pack
Aluminium					
826984	150	50	Landscape	Warning; laser beam	1 / Pack
826986	450	150	Landscape	Warning; laser beam	1 / Pack
826981	148	210	Portrait	Warning; laser beam	1 / Pack
826982	210	297	Portrait	Warning; laser beam	1 / Pack
826985	297	105	Portrait	Warning; laser beam	1 / Pack
826983	297	420	Portrait	Warning; laser beam	1 / Pack



PICTOGRAMS ON ROLLS

Order Ref.	Width (mm)	Height (mm)	Total Qty/ Pack
Laminated Polyester			
826906	25	22	250 / Roll
826908	50	43	250 / Roll
826910	100	87	250 / Roll



PHOTOLUMINESCENT SIGNS

Order Ref.	Width (mm)	Height (mm)	Class	Total Qty/ Pack
Class B Photoluminescent Polyester				
836138	150	130	Class B	1 / Pack
Class C Photoluminescent Polyester				
836139	150	130	Class C	1 / Pack
Class B Photoluminescent Polypropylene				
836136	150	130	Class B	1 / Pack
Class C Photoluminescent Polypropylene				
836137	150	130	Class C	1 / Pack
Class C Photoluminescent Aluminium				
836135	150	130	Class C	1 / Pack

i For all material properties and applications, see pages 4-5

BRADY Customise-it See page 196 to order your custom-made signs.

Complies with EN ISO 7010

W005 : WARNING; NON-IONIZING RADIATION

Non-ionising radiation has a limited and barely visible effect. One of the main principles of this radiation is a heating-up of the body. This radiation includes infra-red, microwaves and radio waves.



SIGNS

Order Ref.	Width (mm)	Height (mm)	Total Qty/ Pack
Laminated Polyester			
827057	50	43	7 / Pack
827059	100	87	3 / Pack
827060	200	173	1 / Pack
827061	315	273	1 / Pack
Polypropylene			
827063	100	87	1 / Pack
827064	200	173	1 / Pack
827065	315	273	1 / Pack
Aluminium			
827066	100	87	1 / Pack
827067	200	173	1 / Pack
827068	315	273	1 / Pack

FLOOR MARKING

Order Ref.	Width (mm)	Height (mm)	Total Qty/ Pack
Anti-skid Laminated Polyester			
827062	500	433	1 / Pack

MINI-PICTOGRAMS

Order Ref.	Width (mm)	Height (mm)	Total Qty/ Pack
Laminated Polyester			
139024	10	9	54 / Pack
827055	25	22	13 / Pack
Vinyl			
827053	15	13	54 / Pack



PICTOGRAMS ON ROLLS

Order Ref.	Width (mm)	Height (mm)	Total Qty/ Pack
Laminated Polyester			
827054	25	22	250 / Roll
827056	50	43	250 / Roll
827058	100	87	250 / Roll

SIGNS WITH TEXT

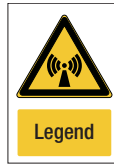

Order Ref.	Width (mm)	Height (mm)	Layout	Legend	Total Qty/ Pack
Laminated Polyester					
827116	150	50	Landscape	Warning; Non-ionizing radiation	1 / Pack
827117	297	74	Landscape	Warning; Non-ionizing radiation	1 / Pack
827119	450	150	Landscape	Warning; Non-ionizing radiation	1 / Pack
827120	600	200	Landscape	Warning; Non-ionizing radiation	1 / Pack
827113	148	210	Portrait	Warning; Non-ionizing radiation	1 / Pack
827114	210	297	Portrait	Warning; Non-ionizing radiation	1 / Pack
827118	297	105	Portrait	Warning; Non-ionizing radiation	1 / Pack
827115	297	420	Portrait	Warning; Non-ionizing radiation	1 / Pack
Polypropylene					
827124	150	50	Landscape	Warning; Non-ionizing radiation	1 / Pack
827125	297	74	Landscape	Warning; Non-ionizing radiation	1 / Pack
827127	450	150	Landscape	Warning; Non-ionizing radiation	1 / Pack
827128	600	200	Landscape	Warning; Non-ionizing radiation	1 / Pack
827121	148	210	Portrait	Warning; Non-ionizing radiation	1 / Pack
827122	210	297	Portrait	Warning; Non-ionizing radiation	1 / Pack
827126	297	105	Portrait	Warning; Non-ionizing radiation	1 / Pack
827123	297	420	Portrait	Warning; Non-ionizing radiation	1 / Pack
Aluminium					
827132	150	50	Landscape	Warning; Non-ionizing radiation	1 / Pack
827134	450	150	Landscape	Warning; Non-ionizing radiation	1 / Pack
827129	148	210	Portrait	Warning; Non-ionizing radiation	1 / Pack
827130	210	297	Portrait	Warning; Non-ionizing radiation	1 / Pack
827133	297	105	Portrait	Warning; Non-ionizing radiation	1 / Pack
827131	297	420	Portrait	Warning; Non-ionizing radiation	1 / Pack



PHOTOLUMINESCENT SIGNS

Order Ref.	Width (mm)	Height (mm)	Class	Total Qty/ Pack
Class B Photoluminescent Polyester				
836143	150	130	Class B	1 / Pack
Class C Photoluminescent Polyester				
836144	150	130	Class C	1 / Pack
Class B Photoluminescent Polypropylene				
836141	150	130	Class B	1 / Pack
Class C Photoluminescent Polypropylene				
836142	150	130	Class C	1 / Pack
Class C Photoluminescent Aluminium				
836140	150	130	Class C	1 / Pack

i For all material properties and applications, see pages 4-5

BRADY Customise-it See page 196 to order your custom-made signs.



W006 : WARNING; MAGNETIC FIELD

Warns that equipment has a strong magnetic field present and can lead to accidents or injury.



SIGNS

Order Ref.	Width (mm)	Height (mm)	Total Qty/ Pack
Laminated Polyester			
827205	50	43	7 / Pack
827207	100	87	3 / Pack
827208	200	173	1 / Pack
827209	315	273	1 / Pack
Polypropylene			
827211	100	87	1 / Pack
827212	200	173	1 / Pack
827213	315	273	1 / Pack
Aluminium			
827214	100	87	1 / Pack
827215	200	173	1 / Pack
827216	315	273	1 / Pack

FLOOR MARKING

Order Ref.	Width (mm)	Height (mm)	Total Qty/ Pack
Anti-skid Laminated Polyester			
827210	500	433	1 / Pack

MINI-PICTOGRAMS

Order Ref.	Width (mm)	Height (mm)	Total Qty/ Pack
Laminated Polyester			
139025	10	9	54 / Pack
827203	25	22	13 / Pack
Vinyl			
827201	15	13	54 / Pack

SIGNS WITH TEXT



Order Ref.	Width (mm)	Height (mm)	Layout	Legend	Total Qty/ Pack
Laminated Polyester					
827264	150	50	Landscape	Warning; Magnetic field	1 / Pack
827265	297	74	Landscape	Warning; Magnetic field	1 / Pack
827267	450	150	Landscape	Warning; Magnetic field	1 / Pack
827268	600	200	Landscape	Warning; Magnetic field	1 / Pack
827261	148	210	Portrait	Warning; Magnetic field	1 / Pack
827262	210	297	Portrait	Warning; Magnetic field	1 / Pack
827266	297	105	Portrait	Warning; Magnetic field	1 / Pack
827263	297	420	Portrait	Warning; Magnetic field	1 / Pack
Polypropylene					
827272	150	50	Landscape	Warning; Magnetic field	1 / Pack
827273	297	74	Landscape	Warning; Magnetic field	1 / Pack
827275	450	150	Landscape	Warning; Magnetic field	1 / Pack
827276	600	200	Landscape	Warning; Magnetic field	1 / Pack
827269	148	210	Portrait	Warning; Magnetic field	1 / Pack
827270	210	297	Portrait	Warning; Magnetic field	1 / Pack
827274	297	105	Portrait	Warning; Magnetic field	1 / Pack
827271	297	420	Portrait	Warning; Magnetic field	1 / Pack
Aluminium					
827280	150	50	Landscape	Warning; Magnetic field	1 / Pack
827282	450	150	Landscape	Warning; Magnetic field	1 / Pack
827277	148	210	Portrait	Warning; Magnetic field	1 / Pack
827278	210	297	Portrait	Warning; Magnetic field	1 / Pack
827281	297	105	Portrait	Warning; Magnetic field	1 / Pack
827279	297	420	Portrait	Warning; Magnetic field	1 / Pack



PICTOGRAMS ON ROLLS

Order Ref.	Width (mm)	Height (mm)	Total Qty/ Pack
Laminated Polyester			
827202	25	22	250 / Roll
827204	50	43	250 / Roll
827206	100	87	250 / Roll



PHOTOLUMINESCENT SIGNS

Order Ref.	Width (mm)	Height (mm)	Class	Total Qty/ Pack
Class B Photoluminescent Polyester				
836148	150	130	Class B	1 / Pack
Class C Photoluminescent Polyester				
836149	150	130	Class C	1 / Pack
Class B Photoluminescent Polypropylene				
836146	150	130	Class B	1 / Pack
Class C Photoluminescent Polypropylene				
836147	150	130	Class C	1 / Pack
Class C Photoluminescent Aluminium				
836145	150	130	Class C	1 / Pack

i For all material properties and applications, see pages 4-5

BRADY Customise-it See page 196 to order your custom-made signs.

Complies with EN ISO 7010

W007 : WARNING; FLOOR LEVEL OBSTACLE

Falling is one of the main causes of workplace accidents. Pointing out the risk areas, and more specifically the type of likely falls, enables you to reduce the number of these accidents.



SIGNS

Order Ref.	Width (mm)	Height (mm)	Total Qty/ Pack
Laminated Polyester			
827353	50	43	7 / Pack
827355	100	87	3 / Pack
827356	200	173	1 / Pack
827357	315	273	1 / Pack
Polypropylene			
827359	100	87	1 / Pack
827360	200	173	1 / Pack
827361	315	273	1 / Pack
Aluminium			
827362	100	87	1 / Pack
827363	200	173	1 / Pack
827364	315	273	1 / Pack

FLOOR MARKING

Order Ref.	Width (mm)	Height (mm)	Total Qty/ Pack
Anti-skid Laminated Polyester			
827358	500	433	1 / Pack

MINI-PICTOGRAMS

Order Ref.	Width (mm)	Height (mm)	Total Qty/ Pack
Laminated Polyester			
139008	10	9	54 / Pack
827351	25	22	13 / Pack
Vinyl			
827349	15	13	54 / Pack



PICTOGRAMS ON ROLLS

Order Ref.	Width (mm)	Height (mm)	Total Qty/ Pack
Laminated Polyester			
827350	25	22	250 / Roll
827352	50	43	250 / Roll
827354	100	87	250 / Roll

SIGNS WITH TEXT



Order Ref.	Width (mm)	Height (mm)	Layout	Legend	Total Qty/ Pack
Laminated Polyester					
827412	150	50	Landscape	Warning; Floor level obstacle	1 / Pack
827413	297	74	Landscape	Warning; Floor level obstacle	1 / Pack
827415	450	150	Landscape	Warning; Floor level obstacle	1 / Pack
827416	600	200	Landscape	Warning; Floor level obstacle	1 / Pack
827409	148	210	Portrait	Warning; Floor level obstacle	1 / Pack
827410	210	297	Portrait	Warning; Floor level obstacle	1 / Pack
827414	297	105	Portrait	Warning; Floor level obstacle	1 / Pack
827411	297	420	Portrait	Warning; Floor level obstacle	1 / Pack
Polypropylene					
827420	150	50	Landscape	Warning; Floor level obstacle	1 / Pack
827421	297	74	Landscape	Warning; Floor level obstacle	1 / Pack
827423	450	150	Landscape	Warning; Floor level obstacle	1 / Pack
827424	600	200	Landscape	Warning; Floor level obstacle	1 / Pack
827417	148	210	Portrait	Warning; Floor level obstacle	1 / Pack
827418	210	297	Portrait	Warning; Floor level obstacle	1 / Pack
827422	297	105	Portrait	Warning; Floor level obstacle	1 / Pack
827419	297	420	Portrait	Warning; Floor level obstacle	1 / Pack
Aluminium					
827428	150	50	Landscape	Warning; Floor level obstacle	1 / Pack
827430	450	150	Landscape	Warning; Floor level obstacle	1 / Pack
827425	148	210	Portrait	Warning; Floor level obstacle	1 / Pack
827426	210	297	Portrait	Warning; Floor level obstacle	1 / Pack
827429	297	105	Portrait	Warning; Floor level obstacle	1 / Pack
827427	297	420	Portrait	Warning; Floor level obstacle	1 / Pack



PHOTOLUMINESCENT SIGNS

Order Ref.	Width (mm)	Height (mm)	Class	Total Qty/ Pack
Class B Photoluminescent Polyester				
836153	150	130	Class B	1 / Pack
Class C Photoluminescent Polyester				
836154	150	130	Class C	1 / Pack
Class B Photoluminescent Polypropylene				
836151	150	130	Class B	1 / Pack
Class C Photoluminescent Polypropylene				
836152	150	130	Class C	1 / Pack
Class C Photoluminescent Aluminium				
836150	150	130	Class C	1 / Pack

i For all material properties and applications, see pages 4-5

BRADY Customise-it See page 196 to order your custom-made signs.



W008 : WARNING; DROP (FALL)

Falling is one of the main causes of workplace accidents. Pointing out the risk areas, and more specifically the type of likely falls, enables you to reduce the number of these accidents.



SIGNS

Order Ref.	Width (mm)	Height (mm)	Total Qty/ Pack
Laminated Polyester			
827501	50	43	7 / Pack
827503	100	87	3 / Pack
827504	200	173	1 / Pack
827505	315	273	1 / Pack
Polypropylene			
827507	100	87	1 / Pack
827508	200	173	1 / Pack
827509	315	273	1 / Pack
Aluminium			
827510	100	87	1 / Pack
827511	200	173	1 / Pack
827512	315	273	1 / Pack

FLOOR MARKING

Order Ref.	Width (mm)	Height (mm)	Total Qty/ Pack
Anti-skid Laminated Polyester			
827506	500	433	1 / Pack

MINI-PICTOGRAMS

Order Ref.	Width (mm)	Height (mm)	Total Qty/ Pack
Laminated Polyester			
139007	10	9	54 / Pack
827499	25	22	13 / Pack
Vinyl			
827497	15	13	54 / Pack

SIGNS WITH TEXT



Order Ref.	Width (mm)	Height (mm)	Layout	Legend	Total Qty/ Pack
Laminated Polyester					
827560	150	50	Landscape	Warning; Drop (fall)	1 / Pack
827561	297	74	Landscape	Warning; Drop (fall)	1 / Pack
827563	450	150	Landscape	Warning; Drop (fall)	1 / Pack
827564	600	200	Landscape	Warning; Drop (fall)	1 / Pack
827557	148	210	Portrait	Warning; Drop (fall)	1 / Pack
827558	210	297	Portrait	Warning; Drop (fall)	1 / Pack
827562	297	105	Portrait	Warning; Drop (fall)	1 / Pack
827559	297	420	Portrait	Warning; Drop (fall)	1 / Pack
Polypropylene					
827568	150	50	Landscape	Warning; Drop (fall)	1 / Pack
827569	297	74	Landscape	Warning; Drop (fall)	1 / Pack
827571	450	150	Landscape	Warning; Drop (fall)	1 / Pack
827572	600	200	Landscape	Warning; Drop (fall)	1 / Pack
827565	148	210	Portrait	Warning; Drop (fall)	1 / Pack
827566	210	297	Portrait	Warning; Drop (fall)	1 / Pack
827570	297	105	Portrait	Warning; Drop (fall)	1 / Pack
827567	297	420	Portrait	Warning; Drop (fall)	1 / Pack
Aluminium					
827576	150	50	Landscape	Warning; Drop (fall)	1 / Pack
827578	450	150	Landscape	Warning; Drop (fall)	1 / Pack
827573	148	210	Portrait	Warning; Drop (fall)	1 / Pack
827574	210	297	Portrait	Warning; Drop (fall)	1 / Pack
827577	297	105	Portrait	Warning; Drop (fall)	1 / Pack
827575	297	420	Portrait	Warning; Drop (fall)	1 / Pack



PICTOGRAMS ON ROLLS

Order Ref.	Width (mm)	Height (mm)	Total Qty/ Pack
Laminated Polyester			
827498	25	22	250 / Roll
827500	50	43	250 / Roll
827502	100	87	250 / Roll



PHOTOLUMINESCENT SIGNS

Order Ref.	Width (mm)	Height (mm)	Class	Total Qty/ Pack
Class B Photoluminescent Polyester				
836158	150	130	Class B	1 / Pack
Class C Photoluminescent Polyester				
836159	150	130	Class C	1 / Pack
Class B Photoluminescent Polypropylene				
836156	150	130	Class B	1 / Pack
Class C Photoluminescent Polypropylene				
836157	150	130	Class C	1 / Pack
Class C Photoluminescent Aluminium				
836155	150	130	Class C	1 / Pack

i For all material properties and applications, see pages 4-5

BRADY Customise-it See page 196 to order your custom-made signs.

Complies with EN ISO 7010

W009 : WARNING; BIOLOGICAL HAZARD

Warn of potential biological hazards around the workplace that could be harmful to employees and visitors.



SIGNS

Order Ref.	Width (mm)	Height (mm)	Total Qty/ Pack
Laminated Polyester			
827649	50	43	7 / Pack
827651	100	87	3 / Pack
827652	200	173	1 / Pack
827653	315	273	1 / Pack
Polypropylene			
827655	100	87	1 / Pack
827656	200	173	1 / Pack
827657	315	273	1 / Pack
Aluminium			
827658	100	87	1 / Pack
827659	200	173	1 / Pack
827660	315	273	1 / Pack

FLOOR MARKING

Order Ref.	Width (mm)	Height (mm)	Total Qty/ Pack
Anti-skid Laminated Polyester			
827654	500	433	1 / Pack

MINI-PICTOGRAMS

Order Ref.	Width (mm)	Height (mm)	Total Qty/ Pack
Laminated Polyester			
139020	10	9	54 / Pack
139021	20	17	15 / Pack
827647	25	22	13 / Pack
Vinyl			
827645	15	13	54 / Pack

SIGNS WITH TEXT



Order Ref.	Width (mm)	Height (mm)	Layout	Legend	Total Qty/ Pack
Laminated Polyester					
827708	150	50	Landscape	Warning; Biological hazard	1 / Pack
827709	297	74	Landscape	Warning; Biological hazard	1 / Pack
827711	450	150	Landscape	Warning; Biological hazard	1 / Pack
827712	600	200	Landscape	Warning; Biological hazard	1 / Pack
827705	148	210	Portrait	Warning; Biological hazard	1 / Pack
827706	210	297	Portrait	Warning; Biological hazard	1 / Pack
827710	297	105	Portrait	Warning; Biological hazard	1 / Pack
827707	297	420	Portrait	Warning; Biological hazard	1 / Pack
Polypropylene					
827716	150	50	Landscape	Warning; Biological hazard	1 / Pack
827717	297	74	Landscape	Warning; Biological hazard	1 / Pack
827719	450	150	Landscape	Warning; Biological hazard	1 / Pack
827720	600	200	Landscape	Warning; Biological hazard	1 / Pack
827713	148	210	Portrait	Warning; Biological hazard	1 / Pack
827714	210	297	Portrait	Warning; Biological hazard	1 / Pack
827718	297	105	Portrait	Warning; Biological hazard	1 / Pack
827715	297	420	Portrait	Warning; Biological hazard	1 / Pack
Aluminium					
827724	150	50	Landscape	Warning; Biological hazard	1 / Pack
827726	450	150	Landscape	Warning; Biological hazard	1 / Pack
827721	148	210	Portrait	Warning; Biological hazard	1 / Pack
827722	210	297	Portrait	Warning; Biological hazard	1 / Pack
827725	297	105	Portrait	Warning; Biological hazard	1 / Pack
827723	297	420	Portrait	Warning; Biological hazard	1 / Pack



PICTOGRAMS ON ROLLS

Order Ref.	Width (mm)	Height (mm)	Total Qty/ Pack
Laminated Polyester			
827646	25	22	250 / Roll
827648	50	43	250 / Roll
827650	100	87	250 / Roll



PHOTOLUMINESCENT SIGNS

Order Ref.	Width (mm)	Height (mm)	Class	Total Qty/ Pack
Class B Photoluminescent Polyester				
836163	150	130	Class B	1 / Pack
Class C Photoluminescent Polyester				
836164	150	130	Class C	1 / Pack
Class B Photoluminescent Polypropylene				
836161	150	130	Class B	1 / Pack
Class C Photoluminescent Polypropylene				
836162	150	130	Class C	1 / Pack
Class C Photoluminescent Aluminium				
836160	150	130	Class C	1 / Pack

i For all material properties and applications, see pages 4-5

BRADY Customise-it See page 196 to order your custom-made signs.



W010 : WARNING; LOW TEMPERATURE/FREEZING CONDITIONS

Use this sign in extremely cold environments, like industrial walk-in freezers. Wearing gloves often is mandatory in these environments. See page 163 for the appropriate sign.



SIGNS

Order Ref.	Width (mm)	Height (mm)	Total Qty/ Pack
Laminated Polyester			
827797	50	43	7 / Pack
827799	100	87	3 / Pack
827800	200	173	1 / Pack
827801	315	273	1 / Pack
Polypropylene			
827803	100	87	1 / Pack
827804	200	173	1 / Pack
827805	315	273	1 / Pack
Aluminium			
827806	100	87	1 / Pack
827807	200	173	1 / Pack
827808	315	273	1 / Pack

FLOOR MARKING

Order Ref.	Width (mm)	Height (mm)	Total Qty/ Pack
Anti-skid Laminated Polyester			
827802	500	433	1 / Pack

MINI-PICTOGRAMS

Order Ref.	Width (mm)	Height (mm)	Total Qty/ Pack
Laminated Polyester			
139011	10	9	54 / Pack
827795	25	22	13 / Pack
Vinyl			
827793	15	13	54 / Pack



PICTOGRAMS ON ROLLS

Order Ref.	Width (mm)	Height (mm)	Total Qty/ Pack
Laminated Polyester			
827794	25	22	250 / Roll
827796	50	43	250 / Roll
827798	100	87	250 / Roll

i For all material properties and applications, see pages 4-5

BRADY Customise-it See page 196 to order your custom-made signs.

i Reversible and irreversible temperature indicating labels provide a record of the temperature of individual components. For more information see page 231.

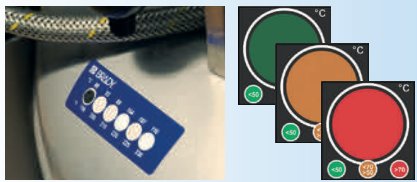

SIGNS WITH TEXT



Order Ref.	Width (mm)	Height (mm)	Layout	Legend	Total Qty/ Pack
Laminated Polyester					
827856	150	50	Landscape	Warning; Low temperature/ freezing conditions	1 / Pack
827857	297	74	Landscape	Warning; Low temperature/ freezing conditions	1 / Pack
827859	450	150	Landscape	Warning; Low temperature/ freezing conditions	1 / Pack
827860	600	200	Landscape	Warning; Low temperature/ freezing conditions	1 / Pack
827853	148	210	Portrait	Warning; Low temperature/ freezing conditions	1 / Pack
827854	210	297	Portrait	Warning; Low temperature/ freezing conditions	1 / Pack
827858	297	105	Portrait	Warning; Low temperature/ freezing conditions	1 / Pack
827855	297	420	Portrait	Warning; Low temperature/ freezing conditions	1 / Pack
Polypropylene					
827864	150	50	Landscape	Warning; Low temperature/ freezing conditions	1 / Pack
827865	297	74	Landscape	Warning; Low temperature/ freezing conditions	1 / Pack
827867	450	150	Landscape	Warning; Low temperature/ freezing conditions	1 / Pack
827868	600	200	Landscape	Warning; Low temperature/ freezing conditions	1 / Pack
827861	148	210	Portrait	Warning; Low temperature/ freezing conditions	1 / Pack
827862	210	297	Portrait	Warning; Low temperature/ freezing conditions	1 / Pack
827866	297	105	Portrait	Warning; Low temperature/ freezing conditions	1 / Pack
827863	297	420	Portrait	Warning; Low temperature/ freezing conditions	1 / Pack
Aluminium					
827872	150	50	Landscape	Warning; Low temperature/ freezing conditions	1 / Pack
827874	450	150	Landscape	Warning; Low temperature/ freezing conditions	1 / Pack
827869	148	210	Portrait	Warning; Low temperature/ freezing conditions	1 / Pack
827870	210	297	Portrait	Warning; Low temperature/ freezing conditions	1 / Pack
827873	297	105	Portrait	Warning; Low temperature/ freezing conditions	1 / Pack
827871	297	420	Portrait	Warning; Low temperature/ freezing conditions	1 / Pack



PHOTOLUMINESCENT SIGNS

Order Ref.	Width (mm)	Height (mm)	Class	Total Qty/ Pack
Class B Photoluminescent Polyester				
836168	150	130	Class B	1 / Pack
Class C Photoluminescent Polyester				
836169	150	130	Class C	1 / Pack
Class B Photoluminescent Polypropylene				
836166	150	130	Class B	1 / Pack
Class C Photoluminescent Polypropylene				
836167	150	130	Class C	1 / Pack
Class C Photoluminescent Aluminium				
836165	150	130	Class C	1 / Pack

Complies with EN ISO 7010

W011 : WARNING; SLIPPERY SURFACE

Slipping is one of the main causes of workplace accidents. Pointing out the risk areas, and more specifically the type of likely falls, enables you to reduce the number of these accidents.



SIGNS

Order Ref.	Width (mm)	Height (mm)	Total Qty/ Pack
Laminated Polyester			
827945	50	43	7 / Pack
827947	100	87	3 / Pack
827948	200	173	1 / Pack
827949	315	273	1 / Pack
Polypropylene			
827951	100	87	1 / Pack
827952	200	173	1 / Pack
827953	315	273	1 / Pack
Aluminium			
827954	100	87	1 / Pack
827955	200	173	1 / Pack
827956	315	273	1 / Pack

FLOOR MARKING

Order Ref.	Width (mm)	Height (mm)	Total Qty/ Pack
Anti-skid Laminated Polyester			
827950	500	433	1 / Pack

MINI-PICTOGRAMS

Order Ref.	Width (mm)	Height (mm)	Total Qty/ Pack
Laminated Polyester			
139009	10	9	54 / Pack
827943	25	22	13 / Pack
Vinyl			
827941	15	13	54 / Pack

SIGNS WITH TEXT



Order Ref.	Width (mm)	Height (mm)	Layout	Legend	Total Qty/ Pack
Laminated Polyester					
828004	150	50	Landscape	Warning; slippery surface	1 / Pack
828005	297	74	Landscape	Warning; slippery surface	1 / Pack
828007	450	150	Landscape	Warning; slippery surface	1 / Pack
828008	600	200	Landscape	Warning; slippery surface	1 / Pack
828001	148	210	Portrait	Warning; slippery surface	1 / Pack
828002	210	297	Portrait	Warning; slippery surface	1 / Pack
828006	297	105	Portrait	Warning; slippery surface	1 / Pack
828003	297	420	Portrait	Warning; slippery surface	1 / Pack
Polypropylene					
828012	150	50	Landscape	Warning; slippery surface	1 / Pack
828013	297	74	Landscape	Warning; slippery surface	1 / Pack
828015	450	150	Landscape	Warning; slippery surface	1 / Pack
828016	600	200	Landscape	Warning; slippery surface	1 / Pack
828009	148	210	Portrait	Warning; slippery surface	1 / Pack
828010	210	297	Portrait	Warning; slippery surface	1 / Pack
828014	297	105	Portrait	Warning; slippery surface	1 / Pack
828011	297	420	Portrait	Warning; slippery surface	1 / Pack
Aluminium					
828020	150	50	Landscape	Warning; slippery surface	1 / Pack
828022	450	150	Landscape	Warning; slippery surface	1 / Pack
828017	148	210	Portrait	Warning; slippery surface	1 / Pack
828018	210	297	Portrait	Warning; slippery surface	1 / Pack
828021	297	105	Portrait	Warning; slippery surface	1 / Pack
828019	297	420	Portrait	Warning; slippery surface	1 / Pack



PICTOGRAMS ON ROLLS

Order Ref.	Width (mm)	Height (mm)	Total Qty/ Pack
Laminated Polyester			
827942	25	22	250 / Roll
827944	50	43	250 / Roll
827946	100	87	250 / Roll



PHOTOLUMINESCENT SIGNS

Order Ref.	Width (mm)	Height (mm)	Class	Total Qty/ Pack
Class B Photoluminescent Polyester				
836173	150	130	Class B	1 / Pack
Class C Photoluminescent Polyester				
836174	150	130	Class C	1 / Pack
Class B Photoluminescent Polypropylene				
836171	150	130	Class B	1 / Pack
Class C Photoluminescent Polypropylene				
836172	150	130	Class C	1 / Pack
Class C Photoluminescent Aluminium				
836170	150	130	Class C	1 / Pack

i For all material properties and applications, see pages 4-5

BRADY Customise-it See page 196 to order your custom-made signs.



W012 : WARNING; ELECTRICITY

The most widely used pictogram in the warnings range, place round all electrical boxes, meters etc., to warn that electricity could be present.



SIGNS

Order Ref.	Width (mm)	Height (mm)	Total Qty/ Pack
Laminated Polyester			
828093	50	43	7 / Pack
828095	100	87	3 / Pack
828096	200	173	1 / Pack
828097	315	273	1 / Pack
Polypropylene			
828099	100	87	1 / Pack
828100	200	173	1 / Pack
828101	315	273	1 / Pack
Aluminium			
828102	100	87	1 / Pack
828103	200	173	1 / Pack
828104	315	273	1 / Pack

FLOOR MARKING

Order Ref.	Width (mm)	Height (mm)	Total Qty/ Pack
Anti-skid Laminated Polyester			
828098	500	433	1 / Pack

MINI-PICTOGRAMS

Order Ref.	Width (mm)	Height (mm)	Total Qty/ Pack
Laminated Polyester			
139001	10	9	54 / Pack
138878	13	11	81 / Pack
139002	20	17	15 / Pack
828091	25	22	13 / Pack
Vinyl			
828089	15	13	54 / Pack

SIGNS WITH TEXT

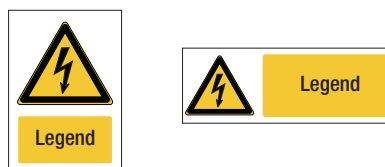

Order Ref.	Width (mm)	Height (mm)	Layout	Legend	Total Qty/ Pack
Laminated Polyester					
828152	150	50	Landscape	Warning; Electricity	1 / Pack
828153	297	74	Landscape	Warning; Electricity	1 / Pack
828155	450	150	Landscape	Warning; Electricity	1 / Pack
828156	600	200	Landscape	Warning; Electricity	1 / Pack
828149	148	210	Portrait	Warning; Electricity	1 / Pack
828150	210	297	Portrait	Warning; Electricity	1 / Pack
828154	297	105	Portrait	Warning; Electricity	1 / Pack
828151	297	420	Portrait	Warning; Electricity	1 / Pack
Polypropylene					
828160	150	50	Landscape	Warning; Electricity	1 / Pack
828161	297	74	Landscape	Warning; Electricity	1 / Pack
828163	450	150	Landscape	Warning; Electricity	1 / Pack
828164	600	200	Landscape	Warning; Electricity	1 / Pack
828157	148	210	Portrait	Warning; Electricity	1 / Pack
828158	210	297	Portrait	Warning; Electricity	1 / Pack
828162	297	105	Portrait	Warning; Electricity	1 / Pack
828159	297	420	Portrait	Warning; Electricity	1 / Pack
Aluminium					
828168	150	50	Landscape	Warning; Electricity	1 / Pack
828170	450	150	Landscape	Warning; Electricity	1 / Pack
828165	148	210	Portrait	Warning; Electricity	1 / Pack
828166	210	297	Portrait	Warning; Electricity	1 / Pack
828169	297	105	Portrait	Warning; Electricity	1 / Pack
828167	297	420	Portrait	Warning; Electricity	1 / Pack



PICTOGRAMS ON ROLLS

Order Ref.	Width (mm)	Height (mm)	Total Qty/ Pack
Laminated Polyester			
828090	25	22	250 / Roll
828092	50	43	250 / Roll
828094	100	87	250 / Roll



PHOTOLUMINESCENT SIGNS

Order Ref.	Width (mm)	Height (mm)	Class	Total Qty/ Pack
Class B Photoluminescent Polyester				
836776	150	130	Class B	1 / Pack
Class B Photoluminescent Polypropylene				
836770	150	130	Class B	1 / Pack

i For all material properties and applications, see pages 4-5

BRADY Customise-it See page 196 to order your custom-made signs.

i See also page 107 for W042 : Warning; Arc flash

IDENTIFICATION OF VOLTAGE, PHASES, EARTH AND ISOLATION

Our comprehensive range of self-adhesive labels for uniformly marking voltage, phases, earth and isolation comply fully with the rules laid down by "The Electricity at Work Regulations 1989". The markers are made from laminated cloth (B-500), which is resistant to heat, dust and oil. The rubber-based adhesive guarantees maximum adhesive strength.

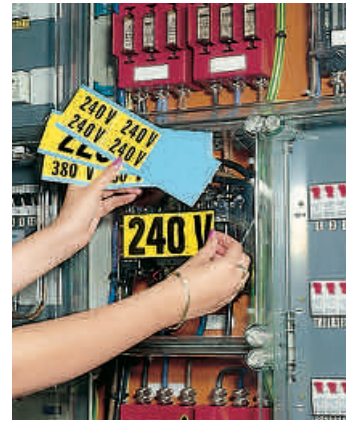

VOLTAGE MARKERS

- Colour: Black on Yellow (other colours available upon request).
- 25 cards per package.

Layout	Width (mm)	Height (mm)	Label cards
Type 1	228	57	1/ Card
Type 2	114	28	4/ Card
Type 3	57	13	18/ Card
Type 4	28	13	36/ Card

Order Ref.	Legend	Layout	Order Ref.	Legend	Layout	Order Ref.	Legend	Layout
244772	3 x 220 VOLT	Type 1	244703	24 VOLT	Type 4	251983	400 / 230 VOLT	Type 3
244773	3 x 220 VOLT	Type 2	244704	48 VOLT	Type 1	251984	400 / 230 VOLT	Type 4
244774	3 x 220 VOLT	Type 3	244705	48 VOLT	Type 2	244849	400 VOLT	Type 1
244775	3 x 220 VOLT	Type 4	244706	48 VOLT	Type 3	244850	400 VOLT	Type 2
244929	3 x 230 V	Type 1	244707	48 VOLT	Type 4	244851	400 VOLT	Type 3
244930	3 x 230 V	Type 2	244708	110 VOLT	Type 1	244852	400 VOLT	Type 4
244931	3 x 230 V	Type 3	244709	110 VOLT	Type 2	244832	500 VOLT	Type 1
244932	3 x 230 V	Type 4	244710	110 VOLT	Type 3	244833	500 VOLT	Type 2
244831	3 x 380 V / 220 V 50 Hz	Type 1	244711	110 VOLT	Type 4	244834	500 VOLT	Type 3
244837	3 x 380 V / 220 V 50 Hz	Type 2	244712	115 VOLT	Type 1	244835	500 VOLT	Type 4
244838	3 x 380 V / 220 V 50 Hz	Type 3	244713	115 VOLT	Type 2	244752	6200 VOLT	Type 1
244839	3 x 380 V / 220 V 50 Hz	Type 4	244714	115 VOLT	Type 3	244753	6200 VOLT	Type 2
244840	3 x 380 V + N	Type 1	244715	115 VOLT	Type 4	244754	6200 VOLT	Type 3
244841	3 x 380 V + N	Type 2	244716	120 VOLT	Type 1	244755	6200 VOLT	Type 4
244842	3 x 380 V + N	Type 3	244717	120 VOLT	Type 2	244756	10000 VOLT	Type 1
244843	3 x 380 V + N	Type 4	244718	120 VOLT	Type 3	244757	10000 VOLT	Type 2
244776	3 x 380 VOLT	Type 1	244719	120 VOLT	Type 4	244758	10000 VOLT	Type 3
244777	3 x 380 VOLT	Type 2	244728	220 VOLT	Type 1	244759	10000 VOLT	Type 4
244778	3 x 380 VOLT	Type 3	244729	220 VOLT	Type 2	251969	11000 VOLT	Type 1
244779	3 x 380 VOLT	Type 4	244730	220 VOLT	Type 3	251970	11000 VOLT	Type 2
251977	3 x 400 / 230 V 50 HZ	Type 1	244731	220 VOLT	Type 4	251971	11000 VOLT	Type 3
251978	3 x 400 / 230 V 50 HZ	Type 2	244732	230 VOLT	Type 1	251972	11000 VOLT	Type 4
251979	3 x 400 / 230 V 50 HZ	Type 3	244733	230 VOLT	Type 2	244760	12000 VOLT	Type 1
251980	3 x 400 / 230 V 50 HZ	Type 4	244734	230 VOLT	Type 3	244761	12000 VOLT	Type 2
244933	3 x 400 V	Type 1	244735	230 VOLT	Type 4	244762	12000 VOLT	Type 3
244934	3 x 400 V	Type 2	244736	240 VOLT	Type 1	244763	12000 VOLT	Type 4
244935	3 x 400 V	Type 3	244737	240 VOLT	Type 2	244800	VOLT	Type 1
244936	3 x 400 V	Type 4	244738	240 VOLT	Type 3	244801	VOLT	Type 2
251973	3 x 400 V + N	Type 1	244739	240 VOLT	Type 4	244802	VOLT	Type 3
251974	3 x 400 V + N	Type 2	244740	380 VOLT	Type 1	244803	VOLT	Type 4
251975	3 x 400 V + N	Type 3	244741	380 VOLT	Type 2			
251976	3 x 400 V + N	Type 4	244742	380 VOLT	Type 3			
244700	24 VOLT	Type 1	244743	380 VOLT	Type 4			
244701	24 VOLT	Type 2	251981	400 / 230 VOLT	Type 1			
244702	24 VOLT	Type 3	251982	400 / 230 VOLT	Type 2			

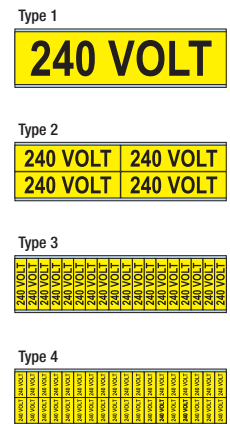

MARKERS FOR VOLTAGE, PHASES, EARTH AND ISOLATION

Order Ref.	Legend	Colour	Width (mm)	Height (mm)	Total Qty/Pack
244824	Earth symbol	Black on Yellow	13	13	1350/ Pack
244827	Earth symbol	Black on White	13	13	1350/ Pack
244825	Earth symbol	Black on Yellow	19	19	825/ Pack
244828	Earth symbol	Black on White	19	19	825/ Pack
244826	Isolation symbol	Black on Yellow	13	13	1350/ Pack
244820	L1, L2, L3, N	Black on Yellow	13	13	1425/ Pack
244821	L1, L2, L3, N	Black on Yellow	19	19	825/ Pack
101386	L1, L2, L3, PE, +, -, "Earth"	Black on White	19	14	800/ Pack
244822	R S T N	Black on Yellow	13	13	1125/ Pack

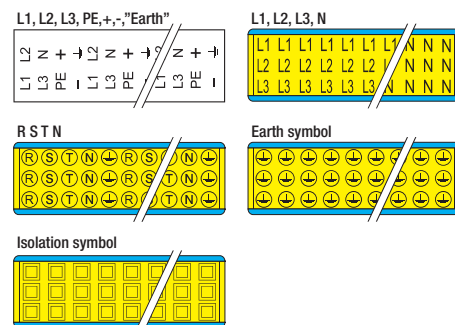



W013 : WARNING; GUARD DOG

Simply indicating the presence of a guard dog will warn potential intruders and help keep premises secure.



SIGNS

Order Ref.	Width (mm)	Height (mm)	Total Qty/ Pack
Laminated Polyester			
828241	50	43	7 / Pack
828243	100	87	3 / Pack
828244	200	173	1 / Pack
828245	315	273	1 / Pack
Polypropylene			
828247	100	87	1 / Pack
828248	200	173	1 / Pack
828249	315	273	1 / Pack
Aluminium			
828250	100	87	1 / Pack
828251	200	173	1 / Pack
828252	315	273	1 / Pack

MINI-PICTOGRAMS

Order Ref.	Width (mm)	Height (mm)	Total Qty/ Pack
Laminated Polyester			
828239	25	22	13 / Pack

SIGNS WITH TEXT



Order Ref.	Width (mm)	Height (mm)	Layout	Legend	Total Qty/ Pack
Laminated Polyester					
828300	150	50	Landscape	Warning; Guard dog	1 / Pack
828301	297	74	Landscape	Warning; Guard dog	1 / Pack
828303	450	150	Landscape	Warning; Guard dog	1 / Pack
828304	600	200	Landscape	Warning; Guard dog	1 / Pack
828297	148	210	Portrait	Warning; Guard dog	1 / Pack
828298	210	297	Portrait	Warning; Guard dog	1 / Pack
828302	297	105	Portrait	Warning; Guard dog	1 / Pack
828299	297	420	Portrait	Warning; Guard dog	1 / Pack
Polypropylene					
828308	150	50	Landscape	Warning; Guard dog	1 / Pack
828309	297	74	Landscape	Warning; Guard dog	1 / Pack
828311	450	150	Landscape	Warning; Guard dog	1 / Pack
828312	600	200	Landscape	Warning; Guard dog	1 / Pack
828305	148	210	Portrait	Warning; Guard dog	1 / Pack
828306	210	297	Portrait	Warning; Guard dog	1 / Pack
828310	297	105	Portrait	Warning; Guard dog	1 / Pack
828307	297	420	Portrait	Warning; Guard dog	1 / Pack
Aluminium					
828316	150	50	Landscape	Warning; Guard dog	1 / Pack
828318	450	150	Landscape	Warning; Guard dog	1 / Pack
828313	148	210	Portrait	Warning; Guard dog	1 / Pack
828314	210	297	Portrait	Warning; Guard dog	1 / Pack
828317	297	105	Portrait	Warning; Guard dog	1 / Pack
828315	297	420	Portrait	Warning; Guard dog	1 / Pack



PICTOGRAMS ON ROLLS

Order Ref.	Width (mm)	Height (mm)	Total Qty/ Pack
Laminated Polyester			
828238	25	22	250 / Roll
828240	50	43	250 / Roll
828242	100	87	250 / Roll



PHOTOLUMINESCENT SIGNS

Order Ref.	Width (mm)	Height (mm)	Class	Total Qty/ Pack
Class B Photoluminescent Polyester				
836179	150	130	Class B	1 / Pack
Class C Photoluminescent Polyester				
836180	150	130	Class C	1 / Pack
Class B Photoluminescent Polypropylene				
836177	150	130	Class B	1 / Pack
Class C Photoluminescent Polypropylene				
836178	150	130	Class C	1 / Pack
Class C Photoluminescent Aluminium				
836176	150	130	Class C	1 / Pack

i For all material properties and applications, see pages 4-5

BRADY Customise-it See page 196 to order your custom-made signs.

Complies with EN ISO 7010

W014 : WARNING; FORK LIFT TRUCKS AND OTHER INDUSTRIAL VEHICLES

Forklift trucks and other vehicles of this type are common across a wide range of sectors. Use these signs to warn employees and visitors that forklift trucks are operating in the area.



It is recommended to combine this sign with floor marking products and a sign to clearly indicate the pedestrian zone (see M024 page 178)



SIGNS

Order Ref.	Width (mm)	Height (mm)	Total Qty/ Pack
Laminated Polyester			
828389	50	43	7 / Pack
828391	100	87	3 / Pack
828392	200	173	1 / Pack
828393	315	273	1 / Pack
Polypropylene			
828395	100	87	1 / Pack
828396	200	173	1 / Pack
828397	315	273	1 / Pack
Aluminium			
828398	100	87	1 / Pack
828399	200	173	1 / Pack
828400	315	273	1 / Pack

FLOOR MARKING

Order Ref.	Width (mm)	Height (mm)	Total Qty/ Pack
Anti-skid Laminated Polyester			
828394	500	433	1 / Pack

MINI-PICTOGRAMS

Order Ref.	Width (mm)	Height (mm)	Total Qty/ Pack
Laminated Polyester			
139000	10	9	54 / Pack
828387	25	22	13 / Pack
Vinyl			
828385	15	13	54 / Pack



PICTOGRAMS ON ROLLS

Order Ref.	Width (mm)	Height (mm)	Total Qty/ Pack
Laminated Polyester			
828386	25	22	250 / Roll
828388	50	43	250 / Roll
828390	100	87	250 / Roll



PHOTOLUMINESCENT SIGNS

Order Ref.	Width (mm)	Height (mm)	Class	Total Qty/ Pack
Class B Photoluminescent Polyester				
836184	150	130	Class B	1 / Pack
Class C Photoluminescent Polyester				
836185	150	130	Class C	1 / Pack
Class B Photoluminescent Polypropylene				
836182	150	130	Class B	1 / Pack
Class C Photoluminescent Polypropylene				
836183	150	130	Class C	1 / Pack
Class C Photoluminescent Aluminium				
836181	150	130	Class C	1 / Pack

SIGNS WITH TEXT



Order Ref.	Width (mm)	Height (mm)	Layout	Legend	Total Qty/ Pack
Laminated Polyester					
828448	150	50	Landscape	Warning; Fork lift trucks and other industrial vehicles	1 / Pack
828449	297	74	Landscape	Warning; Fork lift trucks and other industrial vehicles	1 / Pack
828451	450	150	Landscape	Warning; Fork lift trucks and other industrial vehicles	1 / Pack
828452	600	200	Landscape	Warning; Fork lift trucks and other industrial vehicles	1 / Pack
828445	148	210	Portrait	Warning; Fork lift trucks and other industrial vehicles	1 / Pack
828446	210	297	Portrait	Warning; Fork lift trucks and other industrial vehicles	1 / Pack
828450	297	105	Portrait	Warning; Fork lift trucks and other industrial vehicles	1 / Pack
828447	297	420	Portrait	Warning; Fork lift trucks and other industrial vehicles	1 / Pack
Polypropylene					
828456	150	50	Landscape	Warning; Fork lift trucks and other industrial vehicles	1 / Pack
828457	297	74	Landscape	Warning; Fork lift trucks and other industrial vehicles	1 / Pack
828459	450	150	Landscape	Warning; Fork lift trucks and other industrial vehicles	1 / Pack
828460	600	200	Landscape	Warning; Fork lift trucks and other industrial vehicles	1 / Pack
828453	148	210	Portrait	Warning; Fork lift trucks and other industrial vehicles	1 / Pack
828454	210	297	Portrait	Warning; Fork lift trucks and other industrial vehicles	1 / Pack
828458	297	105	Portrait	Warning; Fork lift trucks and other industrial vehicles	1 / Pack
828455	297	420	Portrait	Warning; Fork lift trucks and other industrial vehicles	1 / Pack
Aluminium					
828464	150	50	Landscape	Warning; Fork lift trucks and other industrial vehicles	1 / Pack
828466	450	150	Landscape	Warning; Fork lift trucks and other industrial vehicles	1 / Pack
828461	148	210	Portrait	Warning; Fork lift trucks and other industrial vehicles	1 / Pack
828462	210	297	Portrait	Warning; Fork lift trucks and other industrial vehicles	1 / Pack
828465	297	105	Portrait	Warning; Fork lift trucks and other industrial vehicles	1 / Pack
828463	297	420	Portrait	Warning; Fork lift trucks and other industrial vehicles	1 / Pack



Forklift inspection system to help control pre-shift inspections, maintenance and identification of forklift trucks.



Brady offers a full range of other methods of marking which identify floor areas, stairs, railings and other areas considered as danger zones. Contact your Brady distributor to find out more about our full range of area marking products.

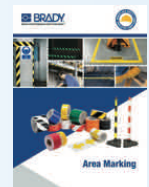



W015 : WARNING; OVERHEAD LOAD

Danger can come from all directions, including from above. To avoid anyone standing underneath overhead loads, pointing them out is crucial.



SIGNS

Order Ref.	Width (mm)	Height (mm)	Total Qty/ Pack
Laminated Polyester			
828537	50	43	7 / Pack
828539	100	87	3 / Pack
828540	200	173	1 / Pack
828541	315	273	1 / Pack
Polypropylene			
828543	100	87	1 / Pack
828544	200	173	1 / Pack
828545	315	273	1 / Pack
Aluminium			
828546	100	87	1 / Pack
828547	200	173	1 / Pack
828548	315	273	1 / Pack

FLOOR MARKING

Order Ref.	Width (mm)	Height (mm)	Total Qty/ Pack
Anti-skid Laminated Polyester			
828542	500	433	1 / Pack

MINI-PICTOGRAMS

Order Ref.	Width (mm)	Height (mm)	Total Qty/ Pack
Laminated Polyester			
138999	10	9	54 / Pack
828535	25	22	13 / Pack
Vinyl			
828533	15	13	54 / Pack

SIGNS WITH TEXT



Order Ref.	Width (mm)	Height (mm)	Layout	Legend	Total Qty/ Pack
Laminated Polyester					
828596	150	50	Landscape	Warning; Overhead load	1 / Pack
828597	297	74	Landscape	Warning; Overhead load	1 / Pack
828599	450	150	Landscape	Warning; Overhead load	1 / Pack
828600	600	200	Landscape	Warning; Overhead load	1 / Pack
828593	148	210	Portrait	Warning; Overhead load	1 / Pack
828594	210	297	Portrait	Warning; Overhead load	1 / Pack
828598	297	105	Portrait	Warning; Overhead load	1 / Pack
828595	297	420	Portrait	Warning; Overhead load	1 / Pack
Polypropylene					
828604	150	50	Landscape	Warning; Overhead load	1 / Pack
828605	297	74	Landscape	Warning; Overhead load	1 / Pack
828607	450	150	Landscape	Warning; Overhead load	1 / Pack
828608	600	200	Landscape	Warning; Overhead load	1 / Pack
828601	148	210	Portrait	Warning; Overhead load	1 / Pack
828602	210	297	Portrait	Warning; Overhead load	1 / Pack
828606	297	105	Portrait	Warning; Overhead load	1 / Pack
828603	297	420	Portrait	Warning; Overhead load	1 / Pack
Aluminium					
828612	150	50	Landscape	Warning; Overhead load	1 / Pack
828614	450	150	Landscape	Warning; Overhead load	1 / Pack
828609	148	210	Portrait	Warning; Overhead load	1 / Pack
828610	210	297	Portrait	Warning; Overhead load	1 / Pack
828613	297	105	Portrait	Warning; Overhead load	1 / Pack
828611	297	420	Portrait	Warning; Overhead load	1 / Pack



PICTOGRAMS ON ROLLS

Order Ref.	Width (mm)	Height (mm)	Total Qty/ Pack
Laminated Polyester			
828534	25	22	250 / Roll
828536	50	43	250 / Roll
828538	100	87	250 / Roll



PHOTOLUMINESCENT SIGNS

Order Ref.	Width (mm)	Height (mm)	Class	Total Qty/ Pack
Class B Photoluminescent Polyester				
836189	150	130	Class B	1 / Pack
Class C Photoluminescent Polyester				
836190	150	130	Class C	1 / Pack
Class B Photoluminescent Polypropylene				
836187	150	130	Class B	1 / Pack
Class C Photoluminescent Polypropylene				
836188	150	130	Class C	1 / Pack
Class C Photoluminescent Aluminium				
836186	150	130	Class C	1 / Pack

i For all material properties and applications, see pages 4-5

BRADY Customise-it See page 196 to order your custom-made signs.

Complies with EN ISO 7010

W016 : WARNING; TOXIC MATERIAL

Toxic materials must be identified so appropriate methods can be taken to store the product safely.



SIGNS

Order Ref.	Width (mm)	Height (mm)	Total Qty/ Pack
Laminated Polyester			
828685	50	43	7 / Pack
828687	100	87	3 / Pack
828688	200	173	1 / Pack
828689	315	273	1 / Pack
Polypropylene			
828691	100	87	1 / Pack
828692	200	173	1 / Pack
828693	315	273	1 / Pack
Aluminium			
828694	100	87	1 / Pack
828695	200	173	1 / Pack
828696	315	273	1 / Pack

FLOOR MARKING

Order Ref.	Width (mm)	Height (mm)	Total Qty/ Pack
Anti-skid Laminated Polyester			
828690	500	433	1 / Pack

MINI-PICTOGRAMS

Order Ref.	Width (mm)	Height (mm)	Total Qty/ Pack
Laminated Polyester			
138996	10	9	54 / Pack
828683	25	22	13 / Pack
Vinyl			
828681	15	13	54 / Pack

SIGNS WITH TEXT



Order Ref.	Width (mm)	Height (mm)	Layout	Legend	Total Qty/ Pack
Laminated Polyester					
828744	150	50	Landscape	Warning; Toxic material	1 / Pack
828745	297	74	Landscape	Warning; Toxic material	1 / Pack
828747	450	150	Landscape	Warning; Toxic material	1 / Pack
828748	600	200	Landscape	Warning; Toxic material	1 / Pack
828741	148	210	Portrait	Warning; Toxic material	1 / Pack
828742	210	297	Portrait	Warning; Toxic material	1 / Pack
828746	297	105	Portrait	Warning; Toxic material	1 / Pack
828743	297	420	Portrait	Warning; Toxic material	1 / Pack
Polypropylene					
828752	150	50	Landscape	Warning; Toxic material	1 / Pack
828753	297	74	Landscape	Warning; Toxic material	1 / Pack
828755	450	150	Landscape	Warning; Toxic material	1 / Pack
828756	600	200	Landscape	Warning; Toxic material	1 / Pack
828749	148	210	Portrait	Warning; Toxic material	1 / Pack
828750	210	297	Portrait	Warning; Toxic material	1 / Pack
828754	297	105	Portrait	Warning; Toxic material	1 / Pack
828751	297	420	Portrait	Warning; Toxic material	1 / Pack
Aluminium					
828760	150	50	Landscape	Warning; Toxic material	1 / Pack
828762	450	150	Landscape	Warning; Toxic material	1 / Pack
828757	148	210	Portrait	Warning; Toxic material	1 / Pack
828758	210	297	Portrait	Warning; Toxic material	1 / Pack
828761	297	105	Portrait	Warning; Toxic material	1 / Pack
828759	297	420	Portrait	Warning; Toxic material	1 / Pack



PICTOGRAMS ON ROLLS

Order Ref.	Width (mm)	Height (mm)	Total Qty/ Pack
Laminated Polyester			
828682	25	22	250 / Roll
828684	50	43	250 / Roll
828686	100	87	250 / Roll



PHOTOLUMINESCENT SIGNS

Order Ref.	Width (mm)	Height (mm)	Class	Total Qty/ Pack
Class B Photoluminescent Polyester				
836781	150	130	Class B	1 / Pack
Class B Photoluminescent Polypropylene				
836777	150	130	Class B	1 / Pack



Use CLP-symbol GHS06 for indicating the dangers of the contents in packages that need to be shipped (see page 221).



For all material properties and applications, see pages 4-5



See page 196 to order your custom-made signs.



W017 : WARNING; HOT SURFACE

By identifying hot surfaces, burn injuries can be avoided and/or the need for wearing safety gloves can be made clear.



This safety message can be amplified with the use of pictogram M009 (see page 163).



SIGNS

Order Ref.	Width (mm)	Height (mm)	Total Qty/Pack
Laminated Polyester			
828833	50	43	7 / Pack
828835	100	87	3 / Pack
828836	200	173	1 / Pack
828837	315	273	1 / Pack
Polypropylene			
828839	100	87	1 / Pack
828840	200	173	1 / Pack
828841	315	273	1 / Pack
Aluminium			
828842	100	87	1 / Pack
828843	200	173	1 / Pack
828844	315	273	1 / Pack

MINI-PICTOGRAMS

Order Ref.	Width (mm)	Height (mm)	Total Qty/Pack
Laminated Polyester			
139013	10	9	54 / Pack
139014	20	17	18 / Pack
828831	25	22	13 / Pack
Vinyl			
828829	15	13	54 / Pack



PICTOGRAMS ON ROLLS

Order Ref.	Width (mm)	Height (mm)	Total Qty/Pack
Laminated Polyester			
828830	25	22	250 / Roll
828832	50	43	250 / Roll
828834	100	87	250 / Roll

i For all material properties and applications, see pages 4-5

BRADY Customise-it See page 196 to order your custom-made signs.

i Reversible and irreversible temperature indicating labels provide a record of the temperature of individual components. For more information see page 231.

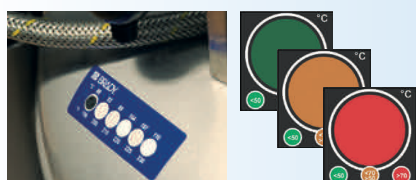

SIGNS WITH TEXT



Order Ref.	Width (mm)	Height (mm)	Layout	Legend	Total Qty/Pack
Laminated Polyester					
828892	150	50	Landscape	Warning; Hot surface	1 / Pack
828893	297	74	Landscape	Warning; Hot surface	1 / Pack
828895	450	150	Landscape	Warning; Hot surface	1 / Pack
828896	600	200	Landscape	Warning; Hot surface	1 / Pack
828889	148	210	Portrait	Warning; Hot surface	1 / Pack
828890	210	297	Portrait	Warning; Hot surface	1 / Pack
828894	297	105	Portrait	Warning; Hot surface	1 / Pack
828891	297	420	Portrait	Warning; Hot surface	1 / Pack
Polypropylene					
828900	150	50	Landscape	Warning; Hot surface	1 / Pack
828901	297	74	Landscape	Warning; Hot surface	1 / Pack
828903	450	150	Landscape	Warning; Hot surface	1 / Pack
828904	600	200	Landscape	Warning; Hot surface	1 / Pack
828897	148	210	Portrait	Warning; Hot surface	1 / Pack
828898	210	297	Portrait	Warning; Hot surface	1 / Pack
828902	297	105	Portrait	Warning; Hot surface	1 / Pack
828899	297	420	Portrait	Warning; Hot surface	1 / Pack
Aluminium					
828908	150	50	Landscape	Warning; Hot surface	1 / Pack
828910	450	150	Landscape	Warning; Hot surface	1 / Pack
828905	148	210	Portrait	Warning; Hot surface	1 / Pack
828906	210	297	Portrait	Warning; Hot surface	1 / Pack
828909	297	105	Portrait	Warning; Hot surface	1 / Pack
828907	297	420	Portrait	Warning; Hot surface	1 / Pack



PHOTOLUMINESCENT SIGNS

Order Ref.	Width (mm)	Height (mm)	Class	Total Qty/Pack
Class B Photoluminescent Polyester				
836196	150	130	Class B	1 / Pack
Class C Photoluminescent Polyester				
836197	150	130	Class C	1 / Pack
Class B Photoluminescent Polypropylene				
836194	150	130	Class B	1 / Pack
Class C Photoluminescent Polypropylene				
836195	150	130	Class C	1 / Pack
Class C Photoluminescent Aluminium				
836193	150	130	Class C	1 / Pack

Complies with EN ISO 7010

W018 : WARNING; AUTOMATIC START-UP

Warning employees and visitors that machinery can start up automatically without any warning.



SIGNS

Order Ref.	Width (mm)	Height (mm)	Total Qty/ Pack
Laminated Polyester			
828981	50	43	7 / Pack
828983	100	87	3 / Pack
828984	200	173	1 / Pack
828985	315	273	1 / Pack
Polypropylene			
828987	100	87	1 / Pack
828988	200	173	1 / Pack
828989	315	273	1 / Pack
Aluminium			
828990	100	87	1 / Pack
828991	200	173	1 / Pack
828992	315	273	1 / Pack

FLOOR MARKING

Order Ref.	Width (mm)	Height (mm)	Total Qty/ Pack
Anti-skid Laminated Polyester			
828986	500	433	1 / Pack

MINI-PICTOGRAMS

Order Ref.	Width (mm)	Height (mm)	Total Qty/ Pack
Laminated Polyester			
139010	10	9	54 / Pack
828979	25	22	13 / Pack
Vinyl			
828977	15	13	54 / Pack

SIGNS WITH TEXT



Order Ref.	Width (mm)	Height (mm)	Layout	Legend	Total Qty/ Pack
Laminated Polyester					
829040	150	50	Landscape	Warning; Automatic start-up	1 / Pack
829041	297	74	Landscape	Warning; Automatic start-up	1 / Pack
829043	450	150	Landscape	Warning; Automatic start-up	1 / Pack
829044	600	200	Landscape	Warning; Automatic start-up	1 / Pack
829037	148	210	Portrait	Warning; Automatic start-up	1 / Pack
829038	210	297	Portrait	Warning; Automatic start-up	1 / Pack
829042	297	105	Portrait	Warning; Automatic start-up	1 / Pack
829039	297	420	Portrait	Warning; Automatic start-up	1 / Pack
Polypropylene					
829048	150	50	Landscape	Warning; Automatic start-up	1 / Pack
829049	297	74	Landscape	Warning; Automatic start-up	1 / Pack
829051	450	150	Landscape	Warning; Automatic start-up	1 / Pack
829052	600	200	Landscape	Warning; Automatic start-up	1 / Pack
829045	148	210	Portrait	Warning; Automatic start-up	1 / Pack
829046	210	297	Portrait	Warning; Automatic start-up	1 / Pack
829050	297	105	Portrait	Warning; Automatic start-up	1 / Pack
829047	297	420	Portrait	Warning; Automatic start-up	1 / Pack
Aluminium					
829056	150	50	Landscape	Warning; Automatic start-up	1 / Pack
829058	450	150	Landscape	Warning; Automatic start-up	1 / Pack
829053	148	210	Portrait	Warning; Automatic start-up	1 / Pack
829054	210	297	Portrait	Warning; Automatic start-up	1 / Pack
829057	297	105	Portrait	Warning; Automatic start-up	1 / Pack
829055	297	420	Portrait	Warning; Automatic start-up	1 / Pack



PICTOGRAMS ON ROLLS

Order Ref.	Width (mm)	Height (mm)	Total Qty/Pack
Laminated Polyester			
828978	25	22	250 / Roll
828980	50	43	250 / Roll
828982	100	87	250 / Roll



PHOTOLUMINESCENT SIGNS

Order Ref.	Width (mm)	Height (mm)	Class	Total Qty/ Pack
Class B Photoluminescent Polyester				
836201	150	130	Class B	1 / Pack
Class C Photoluminescent Polyester				
836202	150	130	Class C	1 / Pack
Class B Photoluminescent Polypropylene				
836199	150	130	Class B	1 / Pack
Class C Photoluminescent Polypropylene				
836200	150	130	Class C	1 / Pack
Class C Photoluminescent Aluminium				
836198	150	130	Class C	1 / Pack

i For all material properties and applications, see pages 4-5

BRADY Customise-it See page 196 to order your custom-made signs.



W019 : WARNING; CRUSHING

If there is a danger of crushing, the person must avoid standing in this area.



SIGNS

Order Ref.	Width (mm)	Height (mm)	Total Qty/ Pack
Laminated Polyester			
829129	50	43	7 / Pack
829131	100	87	3 / Pack
829132	200	173	1 / Pack
829133	315	273	1 / Pack
Polypropylene			
829135	100	87	1 / Pack
829136	200	173	1 / Pack
829137	315	273	1 / Pack
Aluminium			
829138	100	87	1 / Pack
829139	200	173	1 / Pack
829140	315	273	1 / Pack

FLOOR MARKING

Order Ref.	Width (mm)	Height (mm)	Total Qty/ Pack
Anti-skid Laminated Polyester			
829134	500	433	1 / Pack

MINI-PICTOGRAMS

Order Ref.	Width (mm)	Height (mm)	Total Qty/ Pack
Laminated Polyester			
139017	10	9	54 / Pack
829127	25	22	13 / Pack
Vinyl			
829125	15	13	54 / Pack



PICTOGRAMS ON ROLLS

Order Ref.	Width (mm)	Height (mm)	Total Qty/Pack
Laminated Polyester			
829126	25	22	250 / Roll
829128	50	43	250 / Roll
829130	100	87	250 / Roll

SIGNS WITH TEXT



Order Ref.	Width (mm)	Height (mm)	Layout	Legend	Total Qty/ Pack
Laminated Polyester					
829188	150	50	Landscape	Warning; Crushing	1 / Pack
829189	297	74	Landscape	Warning; Crushing	1 / Pack
829191	450	150	Landscape	Warning; Crushing	1 / Pack
829192	600	200	Landscape	Warning; Crushing	1 / Pack
829185	148	210	Portrait	Warning; Crushing	1 / Pack
829186	210	297	Portrait	Warning; Crushing	1 / Pack
829190	297	105	Portrait	Warning; Crushing	1 / Pack
829187	297	420	Portrait	Warning; Crushing	1 / Pack
Polypropylene					
829196	150	50	Landscape	Warning; Crushing	1 / Pack
829197	297	74	Landscape	Warning; Crushing	1 / Pack
829199	450	150	Landscape	Warning; Crushing	1 / Pack
829200	600	200	Landscape	Warning; Crushing	1 / Pack
829193	148	210	Portrait	Warning; Crushing	1 / Pack
829194	210	297	Portrait	Warning; Crushing	1 / Pack
829198	297	105	Portrait	Warning; Crushing	1 / Pack
829195	297	420	Portrait	Warning; Crushing	1 / Pack
Aluminium					
829204	150	50	Landscape	Warning; Crushing	1 / Pack
829206	450	150	Landscape	Warning; Crushing	1 / Pack
829201	148	210	Portrait	Warning; Crushing	1 / Pack
829202	210	297	Portrait	Warning; Crushing	1 / Pack
829205	297	105	Portrait	Warning; Crushing	1 / Pack
829203	297	420	Portrait	Warning; Crushing	1 / Pack



PHOTOLUMINESCENT SIGNS

Order Ref.	Width (mm)	Height (mm)	Class	Total Qty/ Pack
Class B Photoluminescent Polyester				
836206	150	130	Class B	1 / Pack
Class C Photoluminescent Polyester				
836207	150	130	Class C	1 / Pack
Class B Photoluminescent Polypropylene				
836204	150	130	Class B	1 / Pack
Class C Photoluminescent Polypropylene				
836205	150	130	Class C	1 / Pack
Class C Photoluminescent Aluminium				
836203	150	130	Class C	1 / Pack

i LOCKOUT/TAGOUT SYSTEMS

Lockout/Tagout is a procedure created to protect workers involved in the maintenance and servicing of tools against the accidental starting of the various energy sources. This is obtained by mechanically isolating, identifying and locking these energy sources. Contact your Brady distributor to find out more about our full range of lockout/tagout systems.



Complies with EN ISO 7010

W020 : WARNING; OVERHEAD OBSTACLES

If there are overhead obstacles, pointing them out draws the attention of people who may be exposed to a risk of collision. In addition, positioning protective foam is advisable where possible.



SIGNS

Order Ref.	Width (mm)	Height (mm)	Total Qty/ Pack
Laminated Polyester			
829277	50	43	7 / Pack
829279	100	87	3 / Pack
829280	200	173	1 / Pack
829281	315	273	1 / Pack
Polypropylene			
829283	100	87	1 / Pack
829284	200	173	1 / Pack
829285	315	273	1 / Pack
Aluminium			
829286	100	87	1 / Pack
829287	200	173	1 / Pack
829288	315	273	1 / Pack

FLOOR MARKING

Order Ref.	Width (mm)	Height (mm)	Total Qty/ Pack
Anti-skid Laminated Polyester			
829282	500	433	1 / Pack

MINI-PICTOGRAMS

Order Ref.	Width (mm)	Height (mm)	Total Qty/ Pack
Laminated Polyester			
829275	25	22	13 / Pack
Vinyl			
829273	15	13	54 / Pack



PICTOGRAMS ON ROLLS

Order Ref.	Width (mm)	Height (mm)	Total Qty/Pack
Laminated Polyester			
829274	25	22	250 / Roll
829276	50	43	250 / Roll
829278	100	87	250 / Roll

SIGNS WITH TEXT



Order Ref.	Width (mm)	Height (mm)	Layout	Legend	Total Qty/ Pack
Laminated Polyester					
829336	150	50	Landscape	Warning; Overhead obstacles	1 / Pack
829337	297	74	Landscape	Warning; Overhead obstacles	1 / Pack
829339	450	150	Landscape	Warning; Overhead obstacles	1 / Pack
829340	600	200	Landscape	Warning; Overhead obstacles	1 / Pack
829333	148	210	Portrait	Warning; Overhead obstacles	1 / Pack
829334	210	297	Portrait	Warning; Overhead obstacles	1 / Pack
829338	297	105	Portrait	Warning; Overhead obstacles	1 / Pack
829335	297	420	Portrait	Warning; Overhead obstacles	1 / Pack
Polypropylene					
829344	150	50	Landscape	Warning; Overhead obstacles	1 / Pack
829345	297	74	Landscape	Warning; Overhead obstacles	1 / Pack
829347	450	150	Landscape	Warning; Overhead obstacles	1 / Pack
829348	600	200	Landscape	Warning; Overhead obstacles	1 / Pack
829341	148	210	Portrait	Warning; Overhead obstacles	1 / Pack
829342	210	297	Portrait	Warning; Overhead obstacles	1 / Pack
829346	297	105	Portrait	Warning; Overhead obstacles	1 / Pack
829343	297	420	Portrait	Warning; Overhead obstacles	1 / Pack
Aluminium					
829352	150	50	Landscape	Warning; Overhead obstacles	1 / Pack
829354	450	150	Landscape	Warning; Overhead obstacles	1 / Pack
829349	148	210	Portrait	Warning; Overhead obstacles	1 / Pack
829350	210	297	Portrait	Warning; Overhead obstacles	1 / Pack
829353	297	105	Portrait	Warning; Overhead obstacles	1 / Pack
829351	297	420	Portrait	Warning; Overhead obstacles	1 / Pack



PHOTOLUMINESCENT SIGNS

Order Ref.	Width (mm)	Height (mm)	Class	Total Qty/ Pack
Class B Photoluminescent Polyester				
836211	150	130	Class B	1 / Pack
Class C Photoluminescent Polyester				
836212	150	130	Class C	1 / Pack
Class B Photoluminescent Polypropylene				
836209	150	130	Class B	1 / Pack
Class C Photoluminescent Polypropylene				
836210	150	130	Class C	1 / Pack
Class C Photoluminescent Aluminium				
836208	150	130	Class C	1 / Pack

i For all material properties and applications, see pages 4-5

BRADY Customise-it See page 196 to order your custom-made signs.

POLYURETHANE SAFETY BUMPERS

Clearly visible, made from polyurethane foam rubber, flexible and sturdy material, optimal shock-absorber. Article numbers can be found in the Brady Area Marking Catalogue.

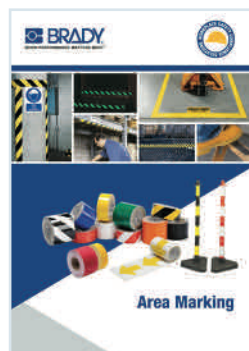

Contact your Brady distributor to find out more about our full range of area marking products.



W021 : WARNING; RISK OF FIRE/FLAMMABLE MATERIALS

Certain precautions need to be taken for the use and storage of flammable materials.



For the transportation of these goods, the use of pictogram GHS02 and a label in line with the CLP regulations are mandatory (see page 221).



We recommend you combine this sign with pictogram P003 to remind people that open flames and smoking are prohibited in areas where these materials are used or stored (see page 113).



SIGNS

Order Ref.	Width (mm)	Height (mm)	Total Qty/ Pack
Laminated Polyester			
829425	50	43	7 / Pack
829427	100	87	3 / Pack
829428	200	173	1 / Pack
829429	315	273	1 / Pack
Polypropylene			
829431	100	87	1 / Pack
829432	200	173	1 / Pack
829433	315	273	1 / Pack
Aluminium			
829434	100	87	1 / Pack
829435	200	173	1 / Pack
829436	315	273	1 / Pack

FLOOR MARKING

Order Ref.	Width (mm)	Height (mm)	Total Qty/ Pack
Anti-skid Laminated Polyester			
829430	500	433	1 / Pack

MINI-PICTOGRAMS

Order Ref.	Width (mm)	Height (mm)	Total Qty/ Pack
Laminated Polyester			
138974	10	9	54 / Pack
829423	25	22	13 / Pack
Vinyl			
829421	15	13	54 / Pack



PICTOGRAMS ON ROLLS

Order Ref.	Width (mm)	Height (mm)	Total Qty/Pack
Laminated Polyester			
829422	25	22	250 / Roll
829424	50	43	250 / Roll
829426	100	87	250 / Roll



PHOTOLUMINESCENT SIGNS

Order Ref.	Width (mm)	Height (mm)	Class	Total Qty/ Pack
Class B Photoluminescent Polyester				
836216	150	130	Class B	1 / Pack
Class C Photoluminescent Polyester				
836217	150	130	Class C	1 / Pack
Class B Photoluminescent Polypropylene				
836214	150	130	Class B	1 / Pack
Class C Photoluminescent Polypropylene				
836215	150	130	Class C	1 / Pack
Class C Photoluminescent Aluminium				
836213	150	130	Class C	1 / Pack

SIGNS WITH TEXT



Order Ref.	Width (mm)	Height (mm)	Layout	Legend	Total Qty/ Pack
Laminated Polyester					
829484	150	50	Landscape	Warning; Risk of fire / flammable materials	1 / Pack
829485	297	74	Landscape	Warning; Risk of fire / flammable materials	1 / Pack
829487	450	150	Landscape	Warning; Risk of fire / flammable materials	1 / Pack
829488	600	200	Landscape	Warning; Risk of fire / flammable materials	1 / Pack
829481	148	210	Portrait	Warning; Risk of fire / flammable materials	1 / Pack
829482	210	297	Portrait	Warning; Risk of fire / flammable materials	1 / Pack
829486	297	105	Portrait	Warning; Risk of fire / flammable materials	1 / Pack
829483	297	420	Portrait	Warning; Risk of fire / flammable materials	1 / Pack
Polypropylene					
829492	150	50	Landscape	Warning; Risk of fire / flammable materials	1 / Pack
829493	297	74	Landscape	Warning; Risk of fire / flammable materials	1 / Pack
829495	450	150	Landscape	Warning; Risk of fire / flammable materials	1 / Pack
829496	600	200	Landscape	Warning; Risk of fire / flammable materials	1 / Pack
829489	148	210	Portrait	Warning; Risk of fire / flammable materials	1 / Pack
829490	210	297	Portrait	Warning; Risk of fire / flammable materials	1 / Pack
829494	297	105	Portrait	Warning; Risk of fire / flammable materials	1 / Pack
829491	297	420	Portrait	Warning; Risk of fire / flammable materials	1 / Pack
Aluminium					
829500	150	50	Landscape	Warning; Risk of fire / flammable materials	1 / Pack
829502	450	150	Landscape	Warning; Risk of fire / flammable materials	1 / Pack
829497	148	210	Portrait	Warning; Risk of fire / flammable materials	1 / Pack
829498	210	297	Portrait	Warning; Risk of fire / flammable materials	1 / Pack
829501	297	105	Portrait	Warning; Risk of fire / flammable materials	1 / Pack
829499	297	420	Portrait	Warning; Risk of fire / flammable materials	1 / Pack



For all material properties and applications, see pages 4-5

BRADY
Customise-it

See page 196 to order your custom-made signs.

Complies with EN ISO 7010

W022 : WARNING; SHARP ELEMENTS

The danger of sharp elements is greatly reduced when they are clearly marked. Identify and warn employees and visitors to be aware of sharp elements and risks associated with it. We recommend that the necessary PPE is worn, for example gloves.

This message can be further clarified by the use of pictogram M009 (see page 163).



SIGNS

Order Ref.	Width (mm)	Height (mm)	Total Qty/Pack
Laminated Polyester			
829573	50	43	7 / Pack
829575	100	87	3 / Pack
829576	200	173	1 / Pack
829577	315	273	1 / Pack
Polypropylene			
829579	100	87	1 / Pack
829580	200	173	1 / Pack
829581	315	273	1 / Pack
Aluminium			
829582	100	87	1 / Pack
829583	200	173	1 / Pack
829584	315	273	1 / Pack

FLOOR MARKING

Order Ref.	Width (mm)	Height (mm)	Total Qty/Pack
Anti-skid Laminated Polyester			
829578	500	433	1 / Pack

MINI-PICTOGRAMS

Order Ref.	Width (mm)	Height (mm)	Total Qty/Pack
Laminated Polyester			
829571	25	22	13 / Pack
Vinyl			
829569	15	13	54 / Pack

SIGNS WITH TEXT



Order Ref.	Width (mm)	Height (mm)	Layout	Legend	Total Qty/Pack
Laminated Polyester					
829632	150	50	Landscape	Sharp elements	1 / Pack
829633	297	74	Landscape	Sharp elements	1 / Pack
829635	450	150	Landscape	Sharp elements	1 / Pack
829636	600	200	Landscape	Sharp elements	1 / Pack
829629	148	210	Portrait	Sharp elements	1 / Pack
829630	210	297	Portrait	Sharp elements	1 / Pack
829634	297	105	Portrait	Sharp elements	1 / Pack
829631	297	420	Portrait	Sharp elements	1 / Pack
Polypropylene					
829640	150	50	Landscape	Sharp elements	1 / Pack
829641	297	74	Landscape	Sharp elements	1 / Pack
829643	450	150	Landscape	Sharp elements	1 / Pack
829644	600	200	Landscape	Sharp elements	1 / Pack
829637	148	210	Portrait	Sharp elements	1 / Pack
829638	210	297	Portrait	Sharp elements	1 / Pack
829642	297	105	Portrait	Sharp elements	1 / Pack
829639	297	420	Portrait	Sharp elements	1 / Pack
Aluminium					
829648	150	50	Landscape	Sharp elements	1 / Pack
829650	450	150	Landscape	Sharp elements	1 / Pack
829645	148	210	Portrait	Sharp elements	1 / Pack
829646	210	297	Portrait	Sharp elements	1 / Pack
829649	297	105	Portrait	Sharp elements	1 / Pack
829647	297	420	Portrait	Sharp elements	1 / Pack



PICTOGRAMS ON ROLLS

Order Ref.	Width (mm)	Height (mm)	Total Qty/Pack
Laminated Polyester			
829570	25	22	250 / Roll
829572	50	43	250 / Roll
829574	100	87	250 / Roll



PHOTOLUMINESCENT SIGNS

Order Ref.	Width (mm)	Height (mm)	Class	Total Qty/Pack
Class B Photoluminescent Polyester				
836221	150	130	Class B	1 / Pack
Class C Photoluminescent Polyester				
836222	150	130	Class C	1 / Pack
Class B Photoluminescent Polypropylene				
836219	150	130	Class B	1 / Pack
Class C Photoluminescent Polypropylene				
836220	150	130	Class C	1 / Pack
Class C Photoluminescent Aluminium				
836218	150	130	Class C	1 / Pack

i For all material properties and applications, see pages 4-5

BRADY Customise-it See page 196 to order your custom-made signs.



W023 : WARNING; CORROSIVE SUBSTANCE

Corrosive substance are extremely dangerous and have specific handling and storage requirements.



During the transportation of such substances the GHS05 pictogram and a CLP-compliant label are absolutely necessary (see page 221).



SIGNS

Order Ref.	Width (mm)	Height (mm)	Total Qty/ Pack
Laminated Polyester			
829721	50	43	7 / Pack
829723	100	87	3 / Pack
829724	200	173	1 / Pack
829725	315	273	1 / Pack
Polypropylene			
829727	100	87	1 / Pack
829728	200	173	1 / Pack
829729	315	273	1 / Pack
Aluminium			
829730	100	87	1 / Pack
829731	200	173	1 / Pack
829732	315	273	1 / Pack

FLOOR MARKING

Order Ref.	Width (mm)	Height (mm)	Total Qty/ Pack
Anti-skid Laminated Polyester			
829726	500	433	1 / Pack

MINI-PICTOGRAMS

Order Ref.	Width (mm)	Height (mm)	Total Qty/ Pack
Laminated Polyester			
138997	10	9	54 / Pack
829719	25	22	13 / Pack
Vinyl			
829717	15	13	54 / Pack

SIGNS WITH TEXT



Order Ref.	Width (mm)	Height (mm)	Layout	Legend	Total Qty/ Pack
Laminated Polyester					
829780	150	50	Landscape	Warning; Corrosive substance	1 / Pack
829781	297	74	Landscape	Warning; Corrosive substance	1 / Pack
829783	450	150	Landscape	Warning; Corrosive substance	1 / Pack
829784	600	200	Landscape	Warning; Corrosive substance	1 / Pack
829777	148	210	Portrait	Warning; Corrosive substance	1 / Pack
829778	210	297	Portrait	Warning; Corrosive substance	1 / Pack
829782	297	105	Portrait	Warning; Corrosive substance	1 / Pack
829779	297	420	Portrait	Warning; Corrosive substance	1 / Pack
Polypropylene					
829788	150	50	Landscape	Warning; Corrosive substance	1 / Pack
829789	297	74	Landscape	Warning; Corrosive substance	1 / Pack
829791	450	150	Landscape	Warning; Corrosive substance	1 / Pack
829792	600	200	Landscape	Warning; Corrosive substance	1 / Pack
829785	148	210	Portrait	Warning; Corrosive substance	1 / Pack
829786	210	297	Portrait	Warning; Corrosive substance	1 / Pack
829790	297	105	Portrait	Warning; Corrosive substance	1 / Pack
829787	297	420	Portrait	Warning; Corrosive substance	1 / Pack
Aluminium					
829796	150	50	Landscape	Warning; Corrosive substance	1 / Pack
829798	450	150	Landscape	Warning; Corrosive substance	1 / Pack
829793	148	210	Portrait	Warning; Corrosive substance	1 / Pack
829794	210	297	Portrait	Warning; Corrosive substance	1 / Pack
829797	297	105	Portrait	Warning; Corrosive substance	1 / Pack
829795	297	420	Portrait	Warning; Corrosive substance	1 / Pack



PICTOGRAMS ON ROLLS

Order Ref.	Width (mm)	Height (mm)	Total Qty/Pack
Laminated Polyester			
829718	25	22	250 / Roll
829720	50	43	250 / Roll
829722	100	87	250 / Roll



PHOTOLUMINESCENT SIGNS

Order Ref.	Width (mm)	Height (mm)	Class	Total Qty/ Pack
Class B Photoluminescent Polyester				
836226	150	130	Class B	1 / Pack
Class C Photoluminescent Polyester				
836227	150	130	Class C	1 / Pack
Class B Photoluminescent Polypropylene				
836224	150	130	Class B	1 / Pack
Class C Photoluminescent Polypropylene				
836225	150	130	Class C	1 / Pack
Class C Photoluminescent Aluminium				
836223	150	130	Class C	1 / Pack

i For all material properties and applications, see pages 4-5

BRADY Customise-it See page 196 to order your custom-made signs.

Complies with EN ISO 7010

W024 : WARNING; CRUSHING OF HANDS

Warn employees to avoid injury to hands when operating the equipment.



SIGNS

Order Ref.	Width (mm)	Height (mm)	Total Qty/ Pack
Laminated Polyester			
829869	50	43	7 / Pack
829871	100	87	3 / Pack
829872	200	173	1 / Pack
829873	315	273	1 / Pack
Polypropylene			
829875	100	87	1 / Pack
829876	200	173	1 / Pack
829877	315	273	1 / Pack
Aluminium			
829878	100	87	1 / Pack
829879	200	173	1 / Pack
829880	315	273	1 / Pack

FLOOR MARKING

Order Ref.	Width (mm)	Height (mm)	Total Qty/ Pack
Anti-skid Laminated Polyester			
829874	500	433	1 / Pack

MINI-PICTOGRAMS

Order Ref.	Width (mm)	Height (mm)	Total Qty/ Pack
Laminated Polyester			
139015	10	9	54 / Pack
139016	20	17	15 / Pack
829867	25	22	13 / Pack
Vinyl			
829865	15	13	54 / Pack



PICTOGRAMS ON ROLLS

Order Ref.	Width (mm)	Height (mm)	Total Qty/Pack
Laminated Polyester			
829866	25	22	250 / Roll
829868	50	43	250 / Roll
829870	100	87	250 / Roll

SIGNS WITH TEXT



Order Ref.	Width (mm)	Height (mm)	Layout	Legend	Total Qty/ Pack
Laminated Polyester					
829928	150	50	Landscape	Warning; Crushing of hands	1 / Pack
829929	297	74	Landscape	Warning; Crushing of hands	1 / Pack
829931	450	150	Landscape	Warning; Crushing of hands	1 / Pack
829932	600	200	Landscape	Warning; Crushing of hands	1 / Pack
829925	148	210	Portrait	Warning; Crushing of hands	1 / Pack
829926	210	297	Portrait	Warning; Crushing of hands	1 / Pack
829930	297	105	Portrait	Warning; Crushing of hands	1 / Pack
829927	297	420	Portrait	Warning; Crushing of hands	1 / Pack
Polypropylene					
829936	150	50	Landscape	Warning; Crushing of hands	1 / Pack
829937	297	74	Landscape	Warning; Crushing of hands	1 / Pack
829939	450	150	Landscape	Warning; Crushing of hands	1 / Pack
829940	600	200	Landscape	Warning; Crushing of hands	1 / Pack
829933	148	210	Portrait	Warning; Crushing of hands	1 / Pack
829934	210	297	Portrait	Warning; Crushing of hands	1 / Pack
829938	297	105	Portrait	Warning; Crushing of hands	1 / Pack
829935	297	420	Portrait	Warning; Crushing of hands	1 / Pack
Aluminium					
829944	150	50	Landscape	Warning; Crushing of hands	1 / Pack
829946	450	150	Landscape	Warning; Crushing of hands	1 / Pack
829941	148	210	Portrait	Warning; Crushing of hands	1 / Pack
829942	210	297	Portrait	Warning; Crushing of hands	1 / Pack
829945	297	105	Portrait	Warning; Crushing of hands	1 / Pack
829943	297	420	Portrait	Warning; Crushing of hands	1 / Pack



PHOTOLUMINESCENT SIGNS

Order Ref.	Width (mm)	Height (mm)	Class	Total Qty/ Pack
Class B Photoluminescent Polyester				
836231	150	130	Class B	1 / Pack
Class C Photoluminescent Polyester				
836232	150	130	Class C	1 / Pack
Class B Photoluminescent Polypropylene				
836229	150	130	Class B	1 / Pack
Class C Photoluminescent Polypropylene				
836230	150	130	Class C	1 / Pack
Class C Photoluminescent Aluminium				
836228	150	130	Class C	1 / Pack

i LOCKOUT/TAGOUT SYSTEMS

Lockout/Tagout is a procedure created to protect workers involved in the maintenance and servicing of tools against the accidental starting of the various energy sources. This is obtained by mechanically isolating, identifying and locking these energy sources. Contact your Brady distributor to find out more about our full range of lockout/tagout systems.





W025 : WARNING; COUNTER ROTATING ROLLERS

Counter-rotating rollers represent a danger (for the hand or more). Use this sign to warn of the dangers and to help prevent injury.



SIGNS

Order Ref.	Width (mm)	Height (mm)	Total Qty/ Pack
Laminated Polyester			
830017	50	43	7 / Pack
830019	100	87	3 / Pack
830020	200	173	1 / Pack
830021	315	273	1 / Pack
Polypropylene			
830023	100	87	1 / Pack
830024	200	173	1 / Pack
830025	315	273	1 / Pack
Aluminium			
830026	100	87	1 / Pack
830027	200	173	1 / Pack
830028	315	273	1 / Pack

FLOOR MARKING

Order Ref.	Width (mm)	Height (mm)	Total Qty/ Pack
Anti-skid Laminated Polyester			
830022	500	433	1 / Pack

MINI-PICTOGRAMS

Order Ref.	Width (mm)	Height (mm)	Total Qty/ Pack
Laminated Polyester			
139018	10	9	54 / Pack
139019	20	17	18 / Pack
830015	25	22	13 / Pack
Vinyl			
830013	15	13	54 / Pack



PICTOGRAMS ON ROLLS

Order Ref.	Width (mm)	Height (mm)	Total Qty/Pack
Laminated Polyester			
830014	25	22	250 / Roll
830016	50	43	250 / Roll
830018	100	87	250 / Roll

SIGNS WITH TEXT

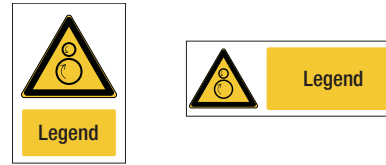

Order Ref.	Width (mm)	Height (mm)	Layout	Legend	Total Qty/ Pack
Laminated Polyester					
830076	150	50	Landscape	Warning; counter rotating rollers	1 / Pack
830077	297	74	Landscape	Warning; counter rotating rollers	1 / Pack
830079	450	150	Landscape	Warning; counter rotating rollers	1 / Pack
830080	600	200	Landscape	Warning; counter rotating rollers	1 / Pack
830073	148	210	Portrait	Warning; counter rotating rollers	1 / Pack
830074	210	297	Portrait	Warning; counter rotating rollers	1 / Pack
830078	297	105	Portrait	Warning; counter rotating rollers	1 / Pack
830075	297	420	Portrait	Warning; counter rotating rollers	1 / Pack
Polypropylene					
830084	150	50	Landscape	Warning; counter rotating rollers	1 / Pack
830085	297	74	Landscape	Warning; counter rotating rollers	1 / Pack
830087	450	150	Landscape	Warning; counter rotating rollers	1 / Pack
830088	600	200	Landscape	Warning; counter rotating rollers	1 / Pack
830081	148	210	Portrait	Warning; counter rotating rollers	1 / Pack
830082	210	297	Portrait	Warning; counter rotating rollers	1 / Pack
830086	297	105	Portrait	Warning; counter rotating rollers	1 / Pack
830083	297	420	Portrait	Warning; counter rotating rollers	1 / Pack
Aluminium					
830092	150	50	Landscape	Warning; counter rotating rollers	1 / Pack
830094	450	150	Landscape	Warning; counter rotating rollers	1 / Pack
830089	148	210	Portrait	Warning; counter rotating rollers	1 / Pack
830090	210	297	Portrait	Warning; counter rotating rollers	1 / Pack
830093	297	105	Portrait	Warning; counter rotating rollers	1 / Pack
830091	297	420	Portrait	Warning; counter rotating rollers	1 / Pack



PHOTOLUMINESCENT SIGNS

Order Ref.	Width (mm)	Height (mm)	Class	Total Qty/ Pack
Class B Photoluminescent Polyester				
836236	150	130	Class B	1 / Pack
Class C Photoluminescent Polyester				
836237	150	130	Class C	1 / Pack
Class B Photoluminescent Polypropylene				
836234	150	130	Class B	1 / Pack
Class C Photoluminescent Polypropylene				
836235	150	130	Class C	1 / Pack
Class C Photoluminescent Aluminium				
836233	150	130	Class C	1 / Pack

i For all material properties and applications, see pages 4-5

BRADY Customise-it See page 196 to order your custom-made signs.

Complies with EN ISO 7010

W026 : WARNING; BATTERY CHARGING

Indicating that a battery is charging avoids it being disconnected by error and warns employees and visitors the dangers of battery charging areas.



SIGNS

Order Ref.	Width (mm)	Height (mm)	Total Qty/ Pack
Laminated Polyester			
830165	50	43	7 / Pack
830167	100	87	3 / Pack
830168	200	173	1 / Pack
830169	315	273	1 / Pack
Polypropylene			
830171	100	87	1 / Pack
830172	200	173	1 / Pack
830173	315	273	1 / Pack
Aluminium			
830174	100	87	1 / Pack
830175	200	173	1 / Pack
830176	315	273	1 / Pack

FLOOR MARKING

Order Ref.	Width (mm)	Height (mm)	Total Qty/ Pack
Anti-skid Laminated Polyester			
830170	500	433	1 / Pack

MINI-PICTOGRAMS

Order Ref.	Width (mm)	Height (mm)	Total Qty/ Pack
Laminated Polyester			
139023	10	9	54 / Pack
830163	25	22	13 / Pack
Vinyl			
830161	15	13	54 / Pack

SIGNS WITH TEXT



Order Ref.	Width (mm)	Height (mm)	Layout	Legend	Total Qty/ Pack
Laminated Polyester					
830224	150	50	Landscape	Warning; Battery charging	1 / Pack
830225	297	74	Landscape	Warning; Battery charging	1 / Pack
830227	450	150	Landscape	Warning; Battery charging	1 / Pack
830228	600	200	Landscape	Warning; Battery charging	1 / Pack
830221	148	210	Portrait	Warning; Battery charging	1 / Pack
830222	210	297	Portrait	Warning; Battery charging	1 / Pack
830226	297	105	Portrait	Warning; Battery charging	1 / Pack
830223	297	420	Portrait	Warning; Battery charging	1 / Pack
Polypropylene					
830232	150	50	Landscape	Warning; Battery charging	1 / Pack
830233	297	74	Landscape	Warning; Battery charging	1 / Pack
830235	450	150	Landscape	Warning; Battery charging	1 / Pack
830236	600	200	Landscape	Warning; Battery charging	1 / Pack
830229	148	210	Portrait	Warning; Battery charging	1 / Pack
830230	210	297	Portrait	Warning; Battery charging	1 / Pack
830234	297	105	Portrait	Warning; Battery charging	1 / Pack
830231	297	420	Portrait	Warning; Battery charging	1 / Pack
Aluminium					
830240	150	50	Landscape	Warning; Battery charging	1 / Pack
830242	450	150	Landscape	Warning; Battery charging	1 / Pack
830237	148	210	Portrait	Warning; Battery charging	1 / Pack
830238	210	297	Portrait	Warning; Battery charging	1 / Pack
830241	297	105	Portrait	Warning; Battery charging	1 / Pack
830239	297	420	Portrait	Warning; Battery charging	1 / Pack



PICTOGRAMS ON ROLLS

Order Ref.	Width (mm)	Height (mm)	Total Qty/Pack
Laminated Polyester			
830162	25	22	250 / Roll
830164	50	43	250 / Roll
830166	100	87	250 / Roll



PHOTOLUMINESCENT SIGNS

Order Ref.	Width (mm)	Height (mm)	Class	Total Qty/ Pack
Class B Photoluminescent Polyester				
836241	150	130	Class B	1 / Pack
Class C Photoluminescent Polyester				
836242	150	130	Class C	1 / Pack
Class B Photoluminescent Polypropylene				
836239	150	130	Class B	1 / Pack
Class C Photoluminescent Polypropylene				
836240	150	130	Class C	1 / Pack
Class C Photoluminescent Aluminium				
836238	150	130	Class C	1 / Pack

i For all material properties and applications, see pages 4-5

BRADY Customise-it See page 196 to order your custom-made signs.



W027 : WARNING; OPTICAL RADIATION

Exposure to optical radiation can cause injury to eyes and therefore limited.



SIGNS

Order Ref.	Width (mm)	Height (mm)	Total Qty/ Pack
Laminated Polyester			
830313	50	43	7 / Pack
830315	100	87	3 / Pack
830316	200	173	1 / Pack
830317	315	273	1 / Pack
Polypropylene			
830319	100	87	1 / Pack
830320	200	173	1 / Pack
830321	315	273	1 / Pack
Aluminium			
830322	100	87	1 / Pack
830323	200	173	1 / Pack
830324	315	273	1 / Pack

FLOOR MARKING

Order Ref.	Width (mm)	Height (mm)	Total Qty/ Pack
Anti-skid Laminated Polyester			
830318	500	433	1 / Pack

MINI-PICTOGRAMS

Order Ref.	Width (mm)	Height (mm)	Total Qty/ Pack
Laminated Polyester			
830311	25	22	13 / Pack
Vinyl			
830309	15	13	54 / Pack

SIGNS WITH TEXT



Order Ref.	Width (mm)	Height (mm)	Layout	Legend	Total Qty/ Pack
Laminated Polyester					
830372	150	50	Landscape	Warning; Optical radiation	1 / Pack
830373	297	74	Landscape	Warning; Optical radiation	1 / Pack
830375	450	150	Landscape	Warning; Optical radiation	1 / Pack
830376	600	200	Landscape	Warning; Optical radiation	1 / Pack
830369	148	210	Portrait	Warning; Optical radiation	1 / Pack
830370	210	297	Portrait	Warning; Optical radiation	1 / Pack
830374	297	105	Portrait	Warning; Optical radiation	1 / Pack
830371	297	420	Portrait	Warning; Optical radiation	1 / Pack
Polypropylene					
830380	150	50	Landscape	Warning; Optical radiation	1 / Pack
830381	297	74	Landscape	Warning; Optical radiation	1 / Pack
830383	450	150	Landscape	Warning; Optical radiation	1 / Pack
830384	600	200	Landscape	Warning; Optical radiation	1 / Pack
830377	148	210	Portrait	Warning; Optical radiation	1 / Pack
830378	210	297	Portrait	Warning; Optical radiation	1 / Pack
830382	297	105	Portrait	Warning; Optical radiation	1 / Pack
830379	297	420	Portrait	Warning; Optical radiation	1 / Pack
Aluminium					
830388	150	50	Landscape	Warning; Optical radiation	1 / Pack
830390	450	150	Landscape	Warning; Optical radiation	1 / Pack
830385	148	210	Portrait	Warning; Optical radiation	1 / Pack
830386	210	297	Portrait	Warning; Optical radiation	1 / Pack
830389	297	105	Portrait	Warning; Optical radiation	1 / Pack
830387	297	420	Portrait	Warning; Optical radiation	1 / Pack



PICTOGRAMS ON ROLLS

Order Ref.	Width (mm)	Height (mm)	Total Qty/Pack
Laminated Polyester			
830310	25	22	250 / Roll
830312	50	43	250 / Roll
830314	100	87	250 / Roll



PHOTOLUMINESCENT SIGNS

Order Ref.	Width (mm)	Height (mm)	Class	Total Qty/ Pack
Class B Photoluminescent Polyester				
836246	150	130	Class B	1 / Pack
Class C Photoluminescent Polyester				
836247	150	130	Class C	1 / Pack
Class B Photoluminescent Polypropylene				
836244	150	130	Class B	1 / Pack
Class C Photoluminescent Polypropylene				
836245	150	130	Class C	1 / Pack
Class C Photoluminescent Aluminium				
836243	150	130	Class C	1 / Pack

i For all material properties and applications, see pages 4-5

BRADY Customise-it See page 196 to order your custom-made signs.

Complies with EN ISO 7010

W028 : WARNING; OXIDIZING SUBSTANCE

An oxidizing substance can ignite a flammable substance. Such substances should therefore be handled and stored accordingly.



During the transportation of such substances the GHS03 pictogramme and a CLP-compliant label are absolutely necessary (see page 221).



SIGNS

Order Ref.	Width (mm)	Height (mm)	Total Qty/ Pack
Laminated Polyester			
830461	50	43	7 / Pack
830463	100	87	3 / Pack
830464	200	173	1 / Pack
830465	315	273	1 / Pack
Polypropylene			
830467	100	87	1 / Pack
830468	200	173	1 / Pack
830469	315	273	1 / Pack
Aluminium			
830470	100	87	1 / Pack
830471	200	173	1 / Pack
830472	315	273	1 / Pack

FLOOR MARKING

Order Ref.	Width (mm)	Height (mm)	Total Qty/ Pack
Anti-skid Laminated Polyester			
830466	500	433	1 / Pack

MINI-PICTOGRAMS

Order Ref.	Width (mm)	Height (mm)	Total Qty/ Pack
Laminated Polyester			
139006	10	9	54 / Pack
830459	25	22	13 / Pack
Vinyl			
830457	15	13	54 / Pack



PICTOGRAMS ON ROLLS

Order Ref.	Width (mm)	Height (mm)	Total Qty/Pack
Laminated Polyester			
830458	25	22	250 / Roll
830460	50	43	250 / Roll
830462	100	87	250 / Roll

SIGNS WITH TEXT



Order Ref.	Width (mm)	Height (mm)	Layout	Legend	Total Qty/ Pack
Laminated Polyester					
830520	150	50	Landscape	Warning; Oxidizing substance	1 / Pack
830521	297	74	Landscape	Warning; Oxidizing substance	1 / Pack
830523	450	150	Landscape	Warning; Oxidizing substance	1 / Pack
830524	600	200	Landscape	Warning; Oxidizing substance	1 / Pack
830517	148	210	Portrait	Warning; Oxidizing substance	1 / Pack
830518	210	297	Portrait	Warning; Oxidizing substance	1 / Pack
830522	297	105	Portrait	Warning; Oxidizing substance	1 / Pack
830519	297	420	Portrait	Warning; Oxidizing substance	1 / Pack
Polypropylene					
830528	150	50	Landscape	Warning; Oxidizing substance	1 / Pack
830529	297	74	Landscape	Warning; Oxidizing substance	1 / Pack
830531	450	150	Landscape	Warning; Oxidizing substance	1 / Pack
830532	600	200	Landscape	Warning; Oxidizing substance	1 / Pack
830525	148	210	Portrait	Warning; Oxidizing substance	1 / Pack
830526	210	297	Portrait	Warning; Oxidizing substance	1 / Pack
830530	297	105	Portrait	Warning; Oxidizing substance	1 / Pack
830527	297	420	Portrait	Warning; Oxidizing substance	1 / Pack
Aluminium					
830536	150	50	Landscape	Warning; Oxidizing substance	1 / Pack
830538	450	150	Landscape	Warning; Oxidizing substance	1 / Pack
830533	148	210	Portrait	Warning; Oxidizing substance	1 / Pack
830534	210	297	Portrait	Warning; Oxidizing substance	1 / Pack
830537	297	105	Portrait	Warning; Oxidizing substance	1 / Pack
830535	297	420	Portrait	Warning; Oxidizing substance	1 / Pack



PHOTOLUMINESCENT SIGNS

Order Ref.	Width (mm)	Height (mm)	Class	Total Qty/ Pack
Class B Photoluminescent Polyester				
836252	150	130	Class B	1 / Pack
Class C Photoluminescent Polyester				
836253	150	130	Class C	1 / Pack
Class B Photoluminescent Polypropylene				
836250	150	130	Class B	1 / Pack
Class C Photoluminescent Polypropylene				
836251	150	130	Class C	1 / Pack
Class C Photoluminescent Aluminium				
836249	150	130	Class C	1 / Pack

i For all material properties and applications, see pages 4-5

BRADY Customise-it See page 196 to order your custom-made signs.



W029 : WARNING; PRESSURISED CYLINDER

Pressurised gas cylinders need to be handled and stored with the necessary care.



For the transportation of gas cylinders, pictogram GHS04 and a label in line with CLP regulations are mandatory (see page 221).



SIGNS

Order Ref.	Width (mm)	Height (mm)	Total Qty/ Pack
Laminated Polyester			
830609	50	43	7 / Pack
830611	100	87	3 / Pack
830612	200	173	1 / Pack
830613	315	273	1 / Pack
Polypropylene			
830615	100	87	1 / Pack
830616	200	173	1 / Pack
830617	315	273	1 / Pack
Aluminium			
830618	100	87	1 / Pack
830619	200	173	1 / Pack
830620	315	273	1 / Pack

FLOOR MARKING

Order Ref.	Width (mm)	Height (mm)	Total Qty/ Pack
Anti-skid Laminated Polyester			
830614	500	433	1 / Pack

MINI-PICTOGRAMS

Order Ref.	Width (mm)	Height (mm)	Total Qty/ Pack
Laminated Polyester			
139012	10	9	54 / Pack
830607	25	22	13 / Pack
Vinyl			
830605	15	13	54 / Pack

SIGNS WITH TEXT



Order Ref.	Width (mm)	Height (mm)	Layout	Legend	Total Qty/ Pack
Laminated Polyester					
830668	150	50	Landscape	Pressurized cylinder	1 / Pack
830669	297	74	Landscape	Pressurized cylinder	1 / Pack
830671	450	150	Landscape	Pressurized cylinder	1 / Pack
830672	600	200	Landscape	Pressurized cylinder	1 / Pack
830665	148	210	Portrait	Pressurized cylinder	1 / Pack
830666	210	297	Portrait	Pressurized cylinder	1 / Pack
830670	297	105	Portrait	Pressurized cylinder	1 / Pack
830667	297	420	Portrait	Pressurized cylinder	1 / Pack
Polypropylene					
830676	150	50	Landscape	Pressurized cylinder	1 / Pack
830677	297	74	Landscape	Pressurized cylinder	1 / Pack
830679	450	150	Landscape	Pressurized cylinder	1 / Pack
830680	600	200	Landscape	Pressurized cylinder	1 / Pack
830673	148	210	Portrait	Pressurized cylinder	1 / Pack
830674	210	297	Portrait	Pressurized cylinder	1 / Pack
830678	297	105	Portrait	Pressurized cylinder	1 / Pack
830675	297	420	Portrait	Pressurized cylinder	1 / Pack
Aluminium					
830684	150	50	Landscape	Pressurized cylinder	1 / Pack
830686	450	150	Landscape	Pressurized cylinder	1 / Pack
830681	148	210	Portrait	Pressurized cylinder	1 / Pack
830682	210	297	Portrait	Pressurized cylinder	1 / Pack
830685	297	105	Portrait	Pressurized cylinder	1 / Pack
830683	297	420	Portrait	Pressurized cylinder	1 / Pack



PICTOGRAMS ON ROLLS

Order Ref.	Width (mm)	Height (mm)	Total Qty/Pack
Laminated Polyester			
830606	25	22	250 / Roll
830608	50	43	250 / Roll
830610	100	87	250 / Roll



PHOTOLUMINESCENT SIGNS

Order Ref.	Width (mm)	Height (mm)	Class	Total Qty/ Pack
Class B Photoluminescent Polyester				
836257	150	130	Class B	1 / Pack
Class C Photoluminescent Polyester				
836258	150	130	Class C	1 / Pack
Class B Photoluminescent Polypropylene				
836255	150	130	Class B	1 / Pack
Class C Photoluminescent Polypropylene				
836256	150	130	Class C	1 / Pack
Class C Photoluminescent Aluminium				
836254	150	130	Class C	1 / Pack

i For all material properties and applications, see pages 4-5

BRADY Customise-it See page 196 to order your custom-made signs.

Complies with EN ISO 7010

W030 : WARNING; HAND CRUSHING BETWEEN PRESS BRAKE TOOL

Warn employees to avoid injury to hands when operating the equipment.



SIGNS

Order Ref.	Width (mm)	Height (mm)	Total Qty/Pack
Laminated Polyester			
831104	50	43	7 / Pack
831106	100	87	3 / Pack
831107	200	173	1 / Pack
831108	315	273	1 / Pack
Polypropylene			
831110	100	87	1 / Pack
831111	200	173	1 / Pack
831112	315	273	1 / Pack
Aluminium			
831113	100	87	1 / Pack
831114	200	173	1 / Pack
831115	315	273	1 / Pack

FLOOR MARKING

Order Ref.	Width (mm)	Height (mm)	Total Qty/Pack
Anti-skid Laminated Polyester			
831109	500	433	1 / Pack

MINI-PICTOGRAMS

Order Ref.	Width (mm)	Height (mm)	Total Qty/Pack
Laminated Polyester			
831102	25	22	13 / Pack
Vinyl			
831100	15	13	54 / Pack



PICTOGRAMS ON ROLLS

Order Ref.	Width (mm)	Height (mm)	Total Qty/Pack
Laminated Polyester			
831101	25	22	250 / Roll
831103	50	43	250 / Roll
831105	100	87	250 / Roll



PHOTOLUMINESCENT SIGNS

Order Ref.	Width (mm)	Height (mm)	Class	Total Qty/Pack
Class B Photoluminescent Polyester				
836262	150	130	Class B	1 / Pack
Class C Photoluminescent Polyester				
836263	150	130	Class C	1 / Pack
Class B Photoluminescent Polypropylene				
836260	150	130	Class B	1 / Pack
Class C Photoluminescent Polypropylene				
836261	150	130	Class C	1 / Pack
Class C Photoluminescent Aluminium				
836259	150	130	Class C	1 / Pack

Complies with EN ISO 7010

W031 : WARNING; HAND CRUSHING BETWEEN PRESS BRAKE TOOL

Warn employees to avoid injury to hands when operating the equipment.



SIGNS

Order Ref.	Width (mm)	Height (mm)	Total Qty/Pack
Laminated Polyester			
831120	50	43	7 / Pack
831122	100	87	3 / Pack
831123	200	173	1 / Pack
831124	315	273	1 / Pack
Polypropylene			
831126	100	87	1 / Pack
831127	200	173	1 / Pack
831128	315	273	1 / Pack
Aluminium			
831129	100	87	1 / Pack
831130	200	173	1 / Pack
831131	315	273	1 / Pack

FLOOR MARKING

Order Ref.	Width (mm)	Height (mm)	Total Qty/Pack
Anti-skid Laminated Polyester			
831125	500	433	1 / Pack

MINI-PICTOGRAMS

Order Ref.	Width (mm)	Height (mm)	Total Qty/Pack
Laminated Polyester			
831118	25	22	13 / Pack
Vinyl			
831116	15	13	54 / Pack



PICTOGRAMS ON ROLLS

Order Ref.	Width (mm)	Height (mm)	Total Qty/Pack
Laminated Polyester			
831117	25	22	250 / Roll
831119	50	43	250 / Roll
831121	100	87	250 / Roll



PHOTOLUMINESCENT SIGNS

Order Ref.	Width (mm)	Height (mm)	Class	Total Qty/Pack
Class B Photoluminescent Polyester				
836267	150	130	Class B	1 / Pack
Class C Photoluminescent Polyester				
836268	150	130	Class C	1 / Pack
Class B Photoluminescent Polypropylene				
836265	150	130	Class B	1 / Pack
Class C Photoluminescent Polypropylene				
836266	150	130	Class C	1 / Pack
Class C Photoluminescent Aluminium				
836264	150	130	Class C	1 / Pack

i For all material properties and applications, see pages 4-5

BRADY Customise-it See page 196 to order your custom-made signs.



W032 : WARNING; RAPID MOVEMENT OF WORKPIECE IN PRESS BRAKE

Warn operators about the possible movement of a workpiece when operating a press brake.



SIGNS

Order Ref.	Width (mm)	Height (mm)	Total Qty/ Pack
Laminated Polyester			
831386	50	43	7 / Pack
831388	100	87	3 / Pack
831389	200	173	1 / Pack
831390	315	273	1 / Pack
Polypropylene			
831392	100	87	1 / Pack
831393	200	173	1 / Pack
831394	315	273	1 / Pack
Aluminium			
831395	100	87	1 / Pack
831396	200	173	1 / Pack
831397	315	273	1 / Pack

FLOOR MARKING

Order Ref.	Width (mm)	Height (mm)	Total Qty/ Pack
Anti-skid Laminated Polyester			
831391	500	433	1 / Pack

MINI-PICTOGRAMS

Order Ref.	Width (mm)	Height (mm)	Total Qty/ Pack
Laminated Polyester			
831384	25	22	13 / Pack
Vinyl			
831382	15	13	54 / Pack



PICTOGRAMS ON ROLLS

Order Ref.	Width (mm)	Height (mm)	Total Qty/ Pack
Laminated Polyester			
831383	25	22	250 / Roll
831385	50	43	250 / Roll
831387	100	87	250 / Roll



PHOTOLUMINESCENT SIGNS

Order Ref.	Width (mm)	Height (mm)	Class	Total Qty/ Pack
Class B Photoluminescent Polyester				
836272	150	130	Class B	1 / Pack
Class C Photoluminescent Polyester				
836273	150	130	Class C	1 / Pack
Class B Photoluminescent Polypropylene				
836270	150	130	Class B	1 / Pack
Class C Photoluminescent Polypropylene				
836271	150	130	Class C	1 / Pack
Class C Photoluminescent Aluminium				
836269	150	130	Class C	1 / Pack



W033 : WARNING; BARBED WIRE

Warn that the area is protected by barbed wire.



SIGNS

Order Ref.	Width (mm)	Height (mm)	Total Qty/ Pack
Laminated Polyester			
831136	50	43	7 / Pack
831138	100	87	3 / Pack
831139	200	173	1 / Pack
831140	315	273	1 / Pack
Polypropylene			
831142	100	87	1 / Pack
831143	200	173	1 / Pack
831144	315	273	1 / Pack
Aluminium			
831145	100	87	1 / Pack
831146	200	173	1 / Pack
831147	315	273	1 / Pack

FLOOR MARKING

Order Ref.	Width (mm)	Height (mm)	Total Qty/ Pack
Laminated Polyester			
831134	25	22	13 / Pack
Vinyl			
831132	15	13	54 / Pack



PHOTOLUMINESCENT SIGNS

Order Ref.	Width (mm)	Height (mm)	Total Qty/ Pack
Laminated Polyester			
831133	25	22	250 / Roll
831135	50	43	250 / Roll
831137	100	87	250 / Roll



MINI-PICTOGRAMS

Order Ref.	Width (mm)	Height (mm)	Class	Total Qty/ Pack
Class B Photoluminescent Polyester				
836277	150	130	Class B	1 / Pack
Class C Photoluminescent Polyester				
836278	150	130	Class C	1 / Pack
Class B Photoluminescent Polypropylene				
836275	150	130	Class B	1 / Pack
Class C Photoluminescent Polypropylene				
836276	150	130	Class C	1 / Pack
Class C Photoluminescent Aluminium				
836274	150	130	Class C	1 / Pack

i For all material properties and applications, see pages 4-5

BRADY Customise-it See page 196 to order your custom-made signs.

Complies with EN ISO 7010

W034 : WARNING; BULL

Where bulls are present, whether roaming free or not, it is preferable to indicate their presence so that passers-by adopt appropriate behaviour or take the necessary precautions.



SIGNS

Order Ref.	Width (mm)	Height (mm)	Total Qty/ Pack
Laminated Polyester			
831152	50	43	7 / Pack
831154	100	87	3 / Pack
831155	200	173	1 / Pack
831156	315	273	1 / Pack
Polypropylene			
831158	100	87	1 / Pack
831159	200	173	1 / Pack
831160	315	273	1 / Pack
Aluminium			
831161	100	87	1 / Pack
831162	200	173	1 / Pack
831163	315	273	1 / Pack

MINI-PICTOGRAMS

Order Ref.	Width (mm)	Height (mm)	Total Qty/ Pack
Laminated Polyester			
831150	25	22	13 / Pack
Vinyl			
831148	15	13	54 / Pack



PICTOGRAMS ON ROLLS

Order Ref.	Width (mm)	Height (mm)	Total Qty/Pack
Laminated Polyester			
831149	25	22	250 / Roll
831151	50	43	250 / Roll
831153	100	87	250 / Roll



PHOTOLUMINESCENT SIGNS

Order Ref.	Width (mm)	Height (mm)	Class	Total Qty/ Pack
Class B Photoluminescent Polyester				
836282	150	130	Class B	1 / Pack
Class C Photoluminescent Polyester				
836283	150	130	Class C	1 / Pack
Class B Photoluminescent Polypropylene				
836280	150	130	Class B	1 / Pack
Class C Photoluminescent Polypropylene				
836281	150	130	Class C	1 / Pack
Class C Photoluminescent Aluminium				
836279	150	130	Class C	1 / Pack

Complies with EN ISO 7010

W035 : WARNING; FALLING OBJECTS

In some area the permanent risk of falling objects needs to be indicated. When this sign needs to be used, it is recommended to combine it with a sign that shows wearing head protection is mandatory (see M014 on page 168).



PANNEAUX PLATS

Order Ref.	Width (mm)	Height (mm)	Total Qty/ Pack
Laminated Polyester			
831168	50	43	7 / Pack
831170	100	87	3 / Pack
831171	200	173	1 / Pack
831172	315	273	1 / Pack
Polypropylene			
831174	100	87	1 / Pack
831175	200	173	1 / Pack
831176	315	273	1 / Pack
Aluminium			
831177	100	87	1 / Pack
831178	200	173	1 / Pack
831179	315	273	1 / Pack

MARQUAGE AU SOL

Order Ref.	Width (mm)	Height (mm)	Total Qty/ Pack
Anti-skid Laminated Polyester			
831173	500	433	1 / Pack

MINI-PICTOGRAMMES

Order Ref.	Width (mm)	Height (mm)	Total Qty/ Pack
Laminated Polyester			
831166	25	22	13 / Pack
Vinyl			
831164	15	13	54 / Pack



PICTOGRAMMES SUR ROULEAUX

Order Ref.	Width (mm)	Height (mm)	Total Qty/Pack
Laminated Polyester			
831165	25	22	250 / Roll
831167	50	43	250 / Roll
831169	100	87	250 / Roll



PANNEAUX PLATS PHOTOLUMINESCENTS

Order Ref.	Width (mm)	Height (mm)	Class	Total Qty/ Pack
Class B Photoluminescent Polyester				
836287	150	130	Class B	1 / Pack
Class C Photoluminescent Polyester				
836288	150	130	Class C	1 / Pack
Class B Photoluminescent Polypropylene				
836285	150	130	Class B	1 / Pack
Class C Photoluminescent Polypropylene				
836286	150	130	Class C	1 / Pack
Class C Photoluminescent Aluminium				
836284	150	130	Class C	1 / Pack

i For all material properties and applications, see pages 4-5

BRADY Customise-it See page 196 to order your custom-made signs.



W036 : WARNING; FRAGILE ROOF

A fragile roof can prove to be dangerous. By installing a danger fragile roof sign, the risk factor could be easily evaded.



SIGNS

Order Ref.	Width (mm)	Height (mm)	Total Qty/ Pack
Laminated Polyester			
831402	50	43	7 / Pack
831404	100	87	3 / Pack
831405	200	173	1 / Pack
831406	315	273	1 / Pack
Polypropylene			
831408	100	87	1 / Pack
831409	200	173	1 / Pack
831410	315	273	1 / Pack
Aluminium			
831411	100	87	1 / Pack
831412	200	173	1 / Pack
831413	315	273	1 / Pack

MINI-PICTOGRAMS

Order Ref.	Width (mm)	Height (mm)	Total Qty/ Pack
Laminated Polyester			
831400	25	22	13 / Pack
Vinyl			
831398	15	13	54 / Pack



PICTOGRAMS ON ROLLS

Order Ref.	Width (mm)	Height (mm)	Total Qty/Pack
Laminated Polyester			
831399	25	22	250 / Roll
831401	50	43	250 / Roll
831403	100	87	250 / Roll



PHOTOLUMINESCENT SIGNS

Order Ref.	Width (mm)	Height (mm)	Class	Total Qty/ Pack
Class B Photoluminescent Polyester				
836292	150	130	Class B	1 / Pack
Class C Photoluminescent Polyester				
836293	150	130	Class C	1 / Pack
Class B Photoluminescent Polypropylene				
836290	150	130	Class B	1 / Pack
Class C Photoluminescent Polypropylene				
836291	150	130	Class C	1 / Pack
Class C Photoluminescent Aluminium				
836289	150	130	Class C	1 / Pack



W037 : WARNING; RUN OVER BY REMOTE OPERATOR CONTROLLED MACHINE

In an automated environment, it is better to indicate that a machine is controlled remotely so that employees or visitors are aware.



PANNEAUX PLATS

Order Ref.	Width (mm)	Height (mm)	Total Qty/ Pack
Laminated Polyester			
135829	100	87	1 / Pack
135830	150	130	1 / Pack
135831	200	173	1 / Pack
Polypropylene			
135823	100	87	1 / Pack
135824	150	130	1 / Pack
135825	200	173	1 / Pack
Aluminium			
135826	100	87	1 / Pack
135827	150	130	1 / Pack
135828	200	173	1 / Pack



PANNEAUX PLATS PHOTOLUMINESCENTS

Order Ref.	Width (mm)	Height (mm)	Class	Total Qty/ Pack
Class B Photoluminescent Polyester				
135838	100	87	Class B	1 / Pack
135839	150	130	Class B	1 / Pack
135840	200	173	Class B	1 / Pack
Class C Photoluminescent Polyester				
135847	100	87	Class C	1 / Pack
135848	150	130	Class C	1 / Pack
135849	200	173	Class C	1 / Pack
Class B Photoluminescent Polypropylene				
135832	100	87	Class B	1 / Pack
135833	150	130	Class B	1 / Pack
135834	200	173	Class B	1 / Pack
Class C Photoluminescent Polypropylene				
135841	100	87	Class C	1 / Pack
135842	150	130	Class C	1 / Pack
135843	200	173	Class C	1 / Pack
Class C Photoluminescent Aluminium				
135844	100	87	Class C	1 / Pack
135845	150	130	Class C	1 / Pack
135846	200	173	Class C	1 / Pack

i For all material properties and applications, see pages 4-5

BRADY Customise-it See page 196 to order your custom-made signs.

Complies with EN ISO 7010

W038 : WARNING; SUDDEN LOUD NOISE

In some production areas sudden loud noises are common. It is important

 to indicate the areas in which this is the case. This sign ideally should be combined with a sign that shows wearing ear protection is mandatory (see M003 on page 157).



SIGNS

Order Ref.	Width (mm)	Height (mm)	Total Qty/ Pack
Laminated Polyester			
831370	50	43	7 / Pack
831372	100	87	3 / Pack
831373	200	173	1 / Pack
831374	315	273	1 / Pack
Polypropylene			
831376	100	87	1 / Pack
831377	200	173	1 / Pack
831378	315	273	1 / Pack
Aluminium			
831379	100	87	1 / Pack
831380	200	173	1 / Pack
831381	315	273	1 / Pack

FLOOR MARKING

Order Ref.	Width (mm)	Height (mm)	Total Qty/ Pack
Anti-skid Laminated Polyester			
831375	500	433	1 / Pack

MINI-PICTOGRAMS

Order Ref.	Width (mm)	Height (mm)	Total Qty/ Pack
Laminated Polyester			
831368	25	22	13 / Pack
Vinyl			
831366	15	13	54 / Pack



PICTOGRAMS ON ROLLS

Order Ref.	Width (mm)	Height (mm)	Total Qty/ Pack
Laminated Polyester			
831367	25	22	250 / Roll
831369	50	43	250 / Roll
831371	100	87	250 / Roll



PHOTOLUMINESCENT SIGNS

Order Ref.	Width (mm)	Height (mm)	Class	Total Qty/ Pack
Class B Photoluminescent Polyester				
836297	150	130	Class B	1 / Pack
Class C Photoluminescent Polyester				
836298	150	130	Class C	1 / Pack
Class B Photoluminescent Polypropylene				
836295	150	130	Class B	1 / Pack
Class C Photoluminescent Polypropylene				
836296	150	130	Class C	1 / Pack
Class C Photoluminescent Aluminium				
836294	150	130	Class C	1 / Pack

Complies with EN ISO 7010

W039 : WARNING; FALLING ICE

Weather and the environment may cause falling ice. Indicating this risk can help people be aware of the danger and stand under these areas, such as not standing under these spaces.



SIGNS

Order Ref.	Width (mm)	Height (mm)	Total Qty/ Pack
Laminated Polyester			
195734	100	87	3 / Pack
195736	200	173	1 / Pack
Polypropylene			
195735	100	87	1 / Pack
195737	200	173	1 / Pack
Aluminium			
195738	100	87	1 / Pack
195739	200	173	1 / Pack



SIGNS WITH TEXT

Order Ref.	Width (mm)	Height (mm)	Layout	Legend	Total Qty/ Pack
Laminated Polyester					
195743	450	150	Landscape	Falling ice	1 / Pack
195742	148	210	Portrait	Falling ice	1 / Pack
195741	210	297	Portrait	Falling ice	1 / Pack
Polypropylene					
195746	450	150	Landscape	Falling ice	1 / Pack
195745	148	210	Portrait	Falling ice	1 / Pack
195744	210	297	Portrait	Falling ice	1 / Pack

i For all material properties and applications, see pages 4-5

BRADY Customise-it See page 196 to order your custom-made signs.

Complies with EN ISO 7010



W040 : WARNING; ROOF AVALANCE

During the cold season, snow on roofs. Due to an increase in temperature or other external factors, this accumulated snow may come down suddenly and cause a roof avalanche. Indicating this warns people not to stand in danger areas.



SIGNS

Order Ref.	Width (mm)	Height (mm)	Total Qty/ Pack
Laminated Polyester			
195753	100	87	3 / Pack
195755	200	173	1 / Pack
Polypropylene			
195754	100	87	1 / Pack
195756	200	173	1 / Pack
Aluminium			
195757	100	87	1 / Pack
195758	200	173	1 / Pack

SIGNS WITH TEXT



Order Ref.	Width (mm)	Height (mm)	Layout	Legend	Total Qty/ Pack
Laminated Polyester					
195762	450	150	Land- scape	Roof avalanche	1 / Pack
195761	148	210	Portrait	Roof avalanche	1 / Pack
195760	210	297	Portrait	Roof avalanche	1 / Pack
Polypropylene					
195765	450	150	Land- scape	Roof avalanche	1 / Pack
195764	148	210	Portrait	Roof avalanche	1 / Pack
195763	210	297	Portrait	Roof avalanche	1 / Pack

Complies with EN ISO 7010



W041 : WARNING; ASPHYXIATING ATMOSPHERE

In confined spaces, the absence of oxygen or the presence of other gases, often colourless and odourless, can be a source of danger and accidents. It is therefore essential to point these areas out as well as any associated bans and the personal protective equipment to be worn.



SIGNS

Order Ref.	Width (mm)	Height (mm)	Total Qty/ Pack
Laminated Polyester			
196000	100	87	1 / Pack
196001	200	173	1 / Pack
Polypropylene			
195996	100	87	1 / Pack
195997	200	173	1 / Pack
Aluminium			
195998	100	87	1 / Pack
195999	200	173	1 / Pack



PHOTOLUMINESCENT SIGNS

Order Ref.	Width (mm)	Height (mm)	Total Qty/ Pack
Class B Photoluminescent Polyester			
196005	100	87	1 / Pack
196006	150	130	1 / Pack
196007	200	173	1 / Pack
Class C Photoluminescent Polyester			
196014	100	87	1 / Pack
196015	150	130	1 / Pack
196016	200	173	1 / Pack
Class B Photoluminescent Polypropylene			
196002	100	87	1 / Pack
196003	150	130	1 / Pack
196004	200	173	1 / Pack
Class C Photoluminescent Polypropylene			
196008	100	87	1 / Pack
196009	150	130	1 / Pack
196010	200	173	1 / Pack
Class C Photoluminescent Aluminium			
196011	100	87	1 / Pack
196012	150	130	1 / Pack
196013	200	173	1 / Pack

i For all material properties and applications, see pages 4-5

BRADY
Customise-it

See page 196 to order your custom-made signs.

Complies with EN ISO 7010

W042 : WARNING; ARC FLASH

Ensure that people are aware of the arc flash hazard of an electrical installation and take proper safety precautions.



SIGNS

Order Ref.	Width (mm)	Height (mm)	Total Qty/ Pack
Laminated Polyester			
198395	10	9	1 / Pack
198363	50	43	7 / Pack
198364	100	87	3 / Pack
198365	200	173	1 / Pack
198366	315	273	1 / Pack
Polypropylene			
198367	100	87	1 / Pack
198368	200	173	1 / Pack
198369	315	273	1 / Pack
Aluminium			
198370	100	87	1 / Pack
198371	200	173	1 / Pack
198372	315	273	1 / Pack

FLOOR MARKING

Order Ref.	Width (mm)	Height (mm)	Total Qty/ Pack
Anti-skid Laminated Polyester			
198404	500	433	1 / Pack

MINI-PICTOGRAMS

Order Ref.	Width (mm)	Height (mm)	Total Qty/ Pack
Laminated Polyester			
198397	13	11	81 / Pack
198398	20	17	18 / Pack
198399	25	22	7 / Pack
Vinyl			
198396	15	13	54 / Pack

PICTOGRAMS ON ROLLS



Order Ref.	Width (mm)	Height (mm)	Total Qty/ Pack
Laminated Polyester			
198400	25	22	250 / Pack
198402	50	43	250 / Pack
198403	100	87	250 / Pack

SIGNS WITH TEXT



Order Ref.	Width (mm)	Height (mm)	Layout	Legend	Total Qty/ Pack
Laminated Polyester					
198373	150	50	Landscape	Warning Arc flash	1 / Pack
198374	297	105	Landscape	Warning Arc flash	1 / Pack
198375	450	150	Landscape	Warning Arc flash	1 / Pack
198376	600	200	Landscape	Warning Arc flash	1 / Pack
198377	148	210	Portrait	Warning Arc flash	1 / Pack
198378	210	297	Portrait	Warning Arc flash	1 / Pack
198379	297	420	Portrait	Warning Arc flash	1 / Pack
Polypropylene					
198380	150	50	Landscape	Warning Arc flash	1 / Pack
198381	297	105	Landscape	Warning Arc flash	1 / Pack
198382	450	150	Landscape	Warning Arc flash	1 / Pack
198383	600	200	Landscape	Warning Arc flash	1 / Pack
198384	148	210	Portrait	Warning Arc flash	1 / Pack
198385	210	297	Portrait	Warning Arc flash	1 / Pack
198386	297	420	Portrait	Warning Arc flash	1 / Pack
Aluminium					
198387	150	50	Landscape	Warning Arc flash	1 / Pack
198388	297	105	Landscape	Warning Arc flash	1 / Pack
198389	450	150	Landscape	Warning Arc flash	1 / Pack
198390	148	210	Portrait	Warning Arc flash	1 / Pack
198391	210	297	Portrait	Warning Arc flash	1 / Pack
198392	297	420	Portrait	Warning Arc flash	1 / Pack

PHOTOLUMINESCENT SIGNS



Order Ref.	Width (mm)	Height (mm)	Total Qty/ Pack
Class B Photoluminescent Polyester			
198393	150	130	1 / Pack
Class B Photoluminescent Polypropylene			
198394	150	130	1 / Pack



See also page 82 for W012 : Warning; Electricity



For all material properties and applications, see pages 4-5



See page 196 to order your custom-made signs.



PIC 2516 (PIC 313) : WARNING; EXPLOSIVE ATMOSPHERE

These size warn employees and visitors of potential explosive hazards in and around the facility.



SIGNS

Order Ref.	Width (mm)	Height (mm)	Total Qty/Pack
Laminated Polyester			
810881	50	43	7 / Pack
810882	100	87	3 / Pack
810885	200	173	1 / Pack
810888	315	273	1 / Pack
Polypropylene			
810883	100	87	1 / Pack
810886	200	173	1 / Pack
810889	315	273	1 / Pack
Aluminium			
810884	100	87	1 / Pack
810887	200	173	1 / Pack
810890	315	273	1 / Pack



PICTOGRAMS ON ROLLS

Order Ref.	Width (mm)	Height (mm)	Total Qty/Pack
Laminated Polyester			
227334	25	22	250 / Roll
227362	50	43	250 / Roll
227309	100	87	250 / Roll



PIC 321 : WARNING; TOXIC IRRITANT HEALTH HAZARD

This sign indicates a toxic substance or irritant. It is recommended to use signs in accordance with NF EN ISO 7010 where possible. For labelling the packaging containing these substances, CLP-labels should be used (see



GHS06 and GHS07 on page 221).



SIGNS

Order Ref.	Width (mm)	Height (mm)	Total Qty/Pack
Laminated Polyester			
250263	50	43	7 / Pack
250264	100	87	3 / Pack
250265	200	173	1 / Pack
223446	315	273	1 / Pack
Polypropylene			
223447	100	87	1 / Pack
252242	200	173	1 / Pack
252243	315	273	1 / Pack
Aluminium			
241648	100	87	1 / Pack
255240	200	173	1 / Pack
255241	315	273	1 / Pack
Vinyl			
802045	50	43	10 / Pack



MINI-PICTOGRAMS

Order Ref.	Width (mm)	Height (mm)	Total Qty/Pack
Vinyl			
802043	10	9	54 / Pack
802044	20	17	15 / Pack



PICTOGRAMS ON ROLLS

Order Ref.	Width (mm)	Height (mm)	Total Qty/Pack
Laminated Polyester			
227339	25	22	250 / Roll
227367	50	43	250 / Roll
227314	100	87	250 / Roll

PIC 327 : WARNING; ELECTROSTATIC

Production of static electricity may be undesirable or even restrictive in the context of industrial production as it could lead to incorrect operation, long-term damage to equipment or, in high-risk cases, an explosion. Its presence must therefore be clearly indicated.



SIGNS

Order Ref.	Width (mm)	Height (mm)	Total Qty/ Pack
Laminated Polyester			
250633	50	43	7 / Pack
250634	100	87	3 / Pack
223405	200	173	1 / Pack
223406	315	273	1 / Pack

MINI-PICTOGRAMS

Order Ref.	Width (mm)	Height (mm)	Total Qty/ Pack
Laminated Polyester			
250630	8	7	117 / Pack
250632	25	22	13 / Pack



PICTOGRAMS ON ROLLS

Order Ref.	Width (mm)	Height (mm)	Total Qty/Pack
Laminated Polyester			
251954	25	22	250 / Roll
223313	50	43	250 / Roll
223314	100	87	250 / Roll

PIC 329 : WARNING; EARTH



SIGNS

Order Ref.	Width (mm)	Height (mm)	Total Qty/ Pack
Laminated Polyester			
250287	50	43	7 / Pack
250288	100	87	3 / Pack
250289	200	173	1 / Pack
223436	315	273	1 / Pack
Polypropylene			
252258	200	173	1 / Pack
252259	315	273	1 / Pack
Aluminium			
241635	100	87	1 / Pack
241636	200	173	1 / Pack
241637	315	273	1 / Pack



PICTOGRAMS ON ROLLS

Order Ref.	Width (mm)	Height (mm)	Total Qty/Pack
Laminated Polyester			
251953	25	22	250 / Roll
223311	50	43	250 / Roll
223312	100	87	250 / Roll

Prohibition

Symbol	Description	Page	Symbol	Description	Page	Symbol	Description	Page
	P001 : General prohibition sign	111		P019 : No stepping on surface	128		P037 : Do not leave the tow-track	144
	P002 : No smoking	112		P020 : Do not use lift in the event of fire	129		P038 : Do not swing the chair	144
	P002/PIC 900 : No smoking including electronic cigarettes	112		P021 : No dogs	130		P040 : Do not set off fireworks	145
	P003 : No open flame; Fire, open ignition source and smoking prohibited	113		P022 : No eating or drinking	131		P041 : No leaning against	146
	P004 : No thoroughfare	114		P023 : Do not obstruct	132		P042 : Not for pregnant women	147
	P005 : Not drinking water	115		P024 : Do not walk or stand here	133		P043 : Not for people in the state of intoxication	148
	P006 : No access for fork lift trucks and other industrial vehicles	116		P025 : Do not use this incomplete scaffold	134		P044 : Use of smart glasses prohibited	149
	P007 : No access for people with active implanted cardiac devices	117		P026 : Do not use this device in a bathtub, shower or water-filled reservoir	135		P046 : Do not stretch out of toboggan	150
	P008 : No metallic articles or watches	118		P027 : Do not use this lift for people	136		P047 : Do not ram into toboggan	151
	P009 : No climbing	119		P028 : Do not wear gloves	137		PIC 209 (=PIC 2110) : No access for unauthorised persons	152
	P010 : Do not touch	119		P029 : No photography	138		PIC 209 (=PIC 2110) : No access for unauthorised persons	152
	P011 : Do not extinguish with water	120		P030 : Do not tie knots in rope	139		PIC 900 : No smoking of electronic cigarettes	152
	P012 : No heavy load	121		P031 : Do not alter the state of the switch	140		PIC 225 : No parking	153
	P013 : No activated mobile phones	122		P032 : Do not use for face grinding	141		PIC 226 : No Stopping (Clearway)	153
	P014 : No access for persons with metallic implants	123		P033 : Do not use for wet grinding	141		PIC 227 : No waiting	153
	P015 : No reaching in	124		P034 : Do not use with hand-held grinding machine	142		PIC 228 : Prohibited for all types of vehicles	153
	P016 : Do not spray with water	125		P035 : Do not wear metal-studded footwear	143		PIC 229 : No entry	153
	P017 : No pushing	126		P036 : No children allowed	143			
	P018 : No sitting	127						

Complies with EN ISO 7010

P001 : GENERAL PROHIBITION SIGN

The P001 prohibition symbol is the most basic and general. For this reason, it is essential to position it with a key clarifying the ban.



SIGNS

Order Ref.	Diameter (mm)	Total Qty/ Pack
Laminated Polyester		
821845	50	2 / Pack
821847	100	1 / Pack
821848	200	1 / Pack
821849	315	1 / Pack
Polypropylene		
821851	100	1 / Pack
821852	200	1 / Pack
821853	315	1 / Pack
Aluminium		
821855	100	1 / Pack
821856	200	1 / Pack
821857	315	1 / Pack

FLOOR MARKING

Order Ref.	Diameter (mm)	Total Qty/ Pack
Anti-skid Laminated Polyester		
821850	500	1 / Pack

MINI-PICTOGRAMS

Order Ref.	Diameter (mm)	Total Qty/ Pack
Laminated Polyester		
821843	25	7 / Pack
Vinyl		
821841	15	54 / Pack



PICTOGRAMS ON ROLLS

Order Ref.	Diameter (mm)	Total Qty/ Pack
Laminated Polyester		
821842	25	250 / Roll
821844	50	250 / Roll
821846	100	250 / Roll

i For all material properties and applications, see pages 4-5

BRADY Customise-it See page 196 to order your custom-made signs.



The P001 prohibition symbol is the most basic and general. For this reason, it is essential to position it with a key clarifying the ban.



P002 : No SMOKING

Widely used symbol in numerous environments, public and private.



SIGNS

Order Ref.	Diameter (mm)	Total Qty/ Pack
Laminated Polyester		
821994	50	2 / Pack
821996	100	1 / Pack
821997	200	1 / Pack
821998	315	1 / Pack
Polypropylene		
822000	100	1 / Pack
822001	200	1 / Pack
822002	315	1 / Pack
822003	400	1 / Pack
Aluminium		
822004	100	1 / Pack
822005	200	1 / Pack
822006	315	1 / Pack

FLOOR MARKING

Order Ref.	Diameter (mm)	Total Qty/ Pack
Anti-skid Laminated Polyester		
821999	500	1 / Pack

MINI-PICTOGRAMS

Order Ref.	Diameter (mm)	Total Qty/ Pack
Laminated Polyester		
138973	20	18 / Pack
821992	25	7 / Pack
Vinyl		
821990	15	54 / Pack



PICTOGRAMS ON ROLLS

Order Ref.	Diameter (mm)	Total Qty/ Pack
Laminated Polyester		
821991	25	250 / Roll
821993	50	250 / Roll
821995	100	250 / Roll

SIGNS WITH TEXT



Order Ref.	Width (mm)	Height (mm)	Layout	Legend	Total Qty/ Pack
Polypropylene					
822062	150	50	Landscape	No smoking	1 / Pack
822063	297	74	Landscape	No smoking	1 / Pack
822065	450	150	Landscape	No smoking	1 / Pack
822066	600	200	Landscape	No smoking	1 / Pack
822059	148	210	Portrait	No smoking	1 / Pack
822060	210	297	Portrait	No smoking	1 / Pack
822064	297	105	Portrait	No smoking	1 / Pack
822061	297	420	Portrait	No smoking	1 / Pack
Aluminium					
822070	150	50	Landscape	No smoking	1 / Pack
822072	450	150	Landscape	No smoking	1 / Pack
822067	148	210	Portrait	No smoking	1 / Pack
822068	210	297	Portrait	No smoking	1 / Pack
822071	297	105	Portrait	No smoking	1 / Pack
822069	297	420	Portrait	No smoking	1 / Pack
Laminated Polyester					
822054	150	50	Landscape	No smoking	1 / Pack
822055	297	74	Landscape	No smoking	1 / Pack
822057	450	150	Landscape	No smoking	1 / Pack
822058	600	200	Landscape	No smoking	1 / Pack
822051	148	210	Portrait	No smoking	1 / Pack
822052	210	297	Portrait	No smoking	1 / Pack
822056	297	105	Portrait	No smoking	1 / Pack
822053	297	420	Portrait	No smoking	1 / Pack



P002/PIC 900 : No SMOKING INCLUDING ELECTRONIC CIGARETTES

With the arrival of electronic cigarettes, these signs can indicate that they are prohibited on your premises.



SIGNS

Order Ref.	Width (mm)	Height (mm)	Total Qty/ Pack
Laminated Polyester			
138506	200	100	1 / Pack

SIGNS WITH TEXT



Order Ref.	Width (mm)	Height (mm)	Legend	Total Qty/ Pack
Laminated Polyester				
138507	420	297	No smoking including electronic cigarettes	1 / Pack
Polypropylene				
138515	420	297	No smoking including electronic cigarettes	1 / Pack

i PIC 900 is also available separately. See page 152.

Complies with EN ISO 7010

P003 : No OPEN FLAME; FIRE, OPEN IGNITION SOURCE AND SMOKING PROHIBITED

Symbol used in a sensitive environment, where the smallest flame may be dangerous.



SIGNS

Order Ref.	Diameter (mm)	Total Qty/Pack
Laminated Polyester		
822143	50	2 / Pack
822145	100	1 / Pack
822146	200	1 / Pack
822147	315	1 / Pack
Polypropylene		
822149	100	1 / Pack
822150	200	1 / Pack
822151	315	1 / Pack
Aluminium		
822153	100	1 / Pack
822154	200	1 / Pack
822155	315	1 / Pack

FLOOR MARKING

Order Ref.	Diameter (mm)	Total Qty/Pack
Anti-skid Laminated Polyester		
822148	500	1 / Pack

MINI-PICTOGRAMS

Order Ref.	Diameter (mm)	Total Qty/Pack
Laminated Polyester		
822141	25	7 / Pack
Vinyl		
822139	15	54 / Pack



PICTOGRAMS ON ROLLS

Order Ref.	Diameter (mm)	Total Qty/Pack
Laminated Polyester		
822140	25	250 / Roll
822142	50	250 / Roll
822144	100	250 / Roll



PHOTOLUMINESCENT SIGNS

Order Ref.	Diameter (mm)	Class	Total Qty/Pack
Class B Photoluminescent Polyester			
836759	200	Class B	1 / Pack
Class B Photoluminescent Polypropylene			
836755	200	Class B	1 / Pack
836758	300	Class B	1 / Pack

SIGNS WITH TEXT



Order Ref.	Width (mm)	Height (mm)	Layout	Legend	Total Qty/Pack
Polypropylene					
822211	150	50	Landscape	No open flame; Fire, open ignition source and smoking prohibited	1 / Pack
822212	297	74	Landscape	No open flame; Fire, open ignition source and smoking prohibited	1 / Pack
822214	450	150	Landscape	No open flame; Fire, open ignition source and smoking prohibited	1 / Pack
822215	600	200	Landscape	No open flame; Fire, open ignition source and smoking prohibited	1 / Pack
822208	148	210	Portrait	No open flame; Fire, open ignition source and smoking prohibited	1 / Pack
822209	210	297	Portrait	No open flame; Fire, open ignition source and smoking prohibited	1 / Pack
822213	297	105	Portrait	No open flame; Fire, open ignition source and smoking prohibited	1 / Pack
822210	297	420	Portrait	No open flame; Fire, open ignition source and smoking prohibited	1 / Pack
Aluminium					
822219	150	50	Landscape	No open flame; Fire, open ignition source and smoking prohibited	1 / Pack
822221	450	150	Landscape	No open flame; Fire, open ignition source and smoking prohibited	1 / Pack
822216	148	210	Portrait	No open flame; Fire, open ignition source and smoking prohibited	1 / Pack
822217	210	297	Portrait	No open flame; Fire, open ignition source and smoking prohibited	1 / Pack
822220	297	105	Portrait	No open flame; Fire, open ignition source and smoking prohibited	1 / Pack
822218	297	420	Portrait	No open flame; Fire, open ignition source and smoking prohibited	1 / Pack
Laminated Polyester					
822203	150	50	Landscape	No open flame; Fire, open ignition source and smoking prohibited	1 / Pack
822204	297	74	Landscape	No open flame; Fire, open ignition source and smoking prohibited	1 / Pack
822206	450	150	Landscape	No open flame; Fire, open ignition source and smoking prohibited	1 / Pack
822207	600	200	Landscape	No open flame; Fire, open ignition source and smoking prohibited	1 / Pack
822200	148	210	Portrait	No open flame; Fire, open ignition source and smoking prohibited	1 / Pack
822201	210	297	Portrait	No open flame; Fire, open ignition source and smoking prohibited	1 / Pack
822205	297	105	Portrait	No open flame; Fire, open ignition source and smoking prohibited	1 / Pack
822202	297	420	Portrait	No open flame; Fire, open ignition source and smoking prohibited	1 / Pack

i For all material properties and applications, see pages 4-5

BRADY Customise-it See page 196 to order your custom-made signs.



P004 : No THOROUGHFARE

To protect pedestrians, it is important to indicate the passageways which are prohibited for pedestrians, as well as those which are authorised (M024, page 178) for better coexistence of pedestrians and machines.



SIGNS

Order Ref.	Diameter (mm)	Total Qty/Pack
Laminated Polyester		
822292	50	2 / Pack
822294	100	1 / Pack
822295	200	1 / Pack
822296	315	1 / Pack
Polypropylene		
822298	100	1 / Pack
822299	200	1 / Pack
822300	315	1 / Pack
Aluminium		
822302	100	1 / Pack
822303	200	1 / Pack
822304	315	1 / Pack

FLOOR MARKING

Order Ref.	Diameter (mm)	Total Qty/Pack
Anti-skid Laminated Polyester		
822297	500	1 / Pack

MINI-PICTOGRAMS

Order Ref.	Diameter (mm)	Total Qty/Pack
Laminated Polyester		
822290	25	7 / Pack
Vinyl		
822288	15	54 / Pack

SIGNS WITH TEXT



Order Ref.	Width (mm)	Height (mm)	Layout	Legend	Total Qty/Pack
Polypropylene					
822360	150	50	Landscape	No thoroughfare	1 / Pack
822361	297	74	Landscape	No thoroughfare	1 / Pack
822363	450	150	Landscape	No thoroughfare	1 / Pack
822364	600	200	Landscape	No thoroughfare	1 / Pack
822357	148	210	Portrait	No thoroughfare	1 / Pack
822358	210	297	Portrait	No thoroughfare	1 / Pack
822362	297	105	Portrait	No thoroughfare	1 / Pack
822359	297	420	Portrait	No thoroughfare	1 / Pack
Aluminium					
822368	150	50	Landscape	No thoroughfare	1 / Pack
822370	450	150	Landscape	No thoroughfare	1 / Pack
822365	148	210	Portrait	No thoroughfare	1 / Pack
822366	210	297	Portrait	No thoroughfare	1 / Pack
822369	297	105	Portrait	No thoroughfare	1 / Pack
822367	297	420	Portrait	No thoroughfare	1 / Pack
Laminated Polyester					
822352	150	50	Landscape	No thoroughfare	1 / Pack
822353	297	74	Landscape	No thoroughfare	1 / Pack
822355	450	150	Landscape	No thoroughfare	1 / Pack
822356	600	200	Landscape	No thoroughfare	1 / Pack
822349	148	210	Portrait	No thoroughfare	1 / Pack
822350	210	297	Portrait	No thoroughfare	1 / Pack
822354	297	105	Portrait	No thoroughfare	1 / Pack
822351	297	420	Portrait	No thoroughfare	1 / Pack



PICTOGRAMS ON ROLLS

Order Ref.	Diameter (mm)	Total Qty/Pack
Laminated Polyester		
822289	25	250 / Roll
822291	50	250 / Roll
822293	100	250 / Roll



PHOTOLUMINESCENT SIGNS

Order Ref.	Diameter (mm)	Class	Total Qty/Pack
Class B Photoluminescent Polyester			
835909	150	Class B	1 / Pack
Class C Photoluminescent Polyester			
835912	150	Class C	1 / Pack
Class B Photoluminescent Polypropylene			
835906	150	Class B	1 / Pack
Class C Photoluminescent Polypropylene			
835908	150	Class C	1 / Pack
Class C Photoluminescent Aluminium			
835905	150	Class C	1 / Pack

Complies with EN ISO 7010

P005 : Not DRINKING WATER

Pointing out that water is not drinkable is crucial. This can avoid an infection due to water unsuitable for consumption.



SIGNS

Order Ref.	Diameter (mm)	Total Qty/Pack
Laminated Polyester		
822441	50	2 / Pack
822443	100	1 / Pack
822444	200	1 / Pack
822445	315	1 / Pack
Polypropylene		
822447	100	1 / Pack
822448	200	1 / Pack
822449	315	1 / Pack
Aluminium		
822451	100	1 / Pack
822452	200	1 / Pack
822453	315	1 / Pack

FLOOR MARKING

Order Ref.	Diameter (mm)	Total Qty/Pack
Anti-skid Laminated Polyester		
822446	500	1 / Pack

MINI-PICTOGRAMS

Order Ref.	Diameter (mm)	Total Qty/Pack
Laminated Polyester		
822439	25	7 / Pack
138978	30	15 / Pack
Vinyl		
822437	15	54 / Pack

SIGNS WITH TEXT



Order Ref.	Width (mm)	Height (mm)	Layout	Legend	Total Qty/Pack
Polypropylene					
822509	150	50	Landscape	Not drinking water	1 / Pack
822510	297	74	Landscape	Not drinking water	1 / Pack
822512	450	150	Landscape	Not drinking water	1 / Pack
822513	600	200	Landscape	Not drinking water	1 / Pack
822506	148	210	Portrait	Not drinking water	1 / Pack
822507	210	297	Portrait	Not drinking water	1 / Pack
822511	297	105	Portrait	Not drinking water	1 / Pack
822508	297	420	Portrait	Not drinking water	1 / Pack
Aluminium					
822517	150	50	Landscape	Not drinking water	1 / Pack
822519	450	150	Landscape	Not drinking water	1 / Pack
822514	148	210	Portrait	Not drinking water	1 / Pack
822515	210	297	Portrait	Not drinking water	1 / Pack
822518	297	105	Portrait	Not drinking water	1 / Pack
822516	297	420	Portrait	Not drinking water	1 / Pack
Laminated Polyester					
822501	150	50	Landscape	Not drinking water	1 / Pack
822502	297	74	Landscape	Not drinking water	1 / Pack
822504	450	150	Landscape	Not drinking water	1 / Pack
822505	600	200	Landscape	Not drinking water	1 / Pack
822498	148	210	Portrait	Not drinking water	1 / Pack
822499	210	297	Portrait	Not drinking water	1 / Pack
822503	297	105	Portrait	Not drinking water	1 / Pack
822500	297	420	Portrait	Not drinking water	1 / Pack



PICTOGRAMS ON ROLLS

Order Ref.	Diameter (mm)	Total Qty/Pack
Laminated Polyester		
822438	25	250 / Roll
822440	50	250 / Roll
822442	100	250 / Roll

i For all material properties and applications, see pages 4-5

BRADY Customise-it See page 196 to order your custom-made signs.

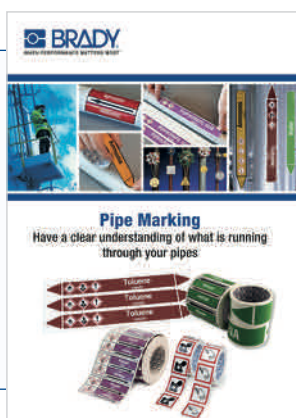

Correct identification of pipes guarantees a better overview of a building's structure. Accidents, injuries and damage can be avoided. Contact your Brady distributor to find out more about our full range of pipe markers.



P006 : No ACCESS FOR FORK LIFT TRUCKS AND OTHER INDUSTRIAL VEHICLES

To make the coexistence of pedestrians and drivers easier in an environment, the rules must be clear and indicated. This symbol indicates a zone prohibited for drivers.



SIGNS

Order Ref.	Diameter (mm)	Total Qty/Pack
Laminated Polyester		
822590	50	2 / Pack
822592	100	1 / Pack
822593	200	1 / Pack
822594	315	1 / Pack
Polypropylene		
822596	100	1 / Pack
822597	200	1 / Pack
822598	315	1 / Pack
822599	400	1 / Pack
Aluminium		
822600	100	1 / Pack
822601	200	1 / Pack
822602	315	1 / Pack

FLOOR MARKING

Order Ref.	Diameter (mm)	Total Qty/Pack
Anti-skid Laminated Polyester		
822595	500	1 / Pack

MINI-PICTOGRAMS

Order Ref.	Diameter (mm)	Total Qty/Pack
Laminated Polyester		
822588	25	7 / Pack
Vinyl		
822586	15	54 / Pack



PICTOGRAMS ON ROLLS

Order Ref.	Diameter (mm)	Total Qty/Pack
Laminated Polyester		
822587	25	250 / Roll
822589	50	250 / Roll
822591	100	250 / Roll



SIGNS WITH TEXT



Order Ref.	Width (mm)	Height (mm)	Layout	Legend	Total Qty/Pack
Polypropylene					
822658	150	50	Landscape	No access for fork lift trucks and other industrial vehicles	1 / Pack
822659	297	74	Landscape	No access for fork lift trucks and other industrial vehicles	1 / Pack
822661	450	150	Landscape	No access for fork lift trucks and other industrial vehicles	1 / Pack
822662	600	200	Landscape	No access for fork lift trucks and other industrial vehicles	1 / Pack
822655	148	210	Portrait	No access for fork lift trucks and other industrial vehicles	1 / Pack
822656	210	297	Portrait	No access for fork lift trucks and other industrial vehicles	1 / Pack
822660	297	105	Portrait	No access for fork lift trucks and other industrial vehicles	1 / Pack
822657	297	420	Portrait	No access for fork lift trucks and other industrial vehicles	1 / Pack
Aluminium					
822666	150	50	Landscape	No access for fork lift trucks and other industrial vehicles	1 / Pack
822668	450	150	Landscape	No access for fork lift trucks and other industrial vehicles	1 / Pack
822663	148	210	Portrait	No access for fork lift trucks and other industrial vehicles	1 / Pack
822664	210	297	Portrait	No access for fork lift trucks and other industrial vehicles	1 / Pack
822667	297	105	Portrait	No access for fork lift trucks and other industrial vehicles	1 / Pack
822665	297	420	Portrait	No access for fork lift trucks and other industrial vehicles	1 / Pack
Laminated Polyester					
822650	150	50	Landscape	No access for fork lift trucks and other industrial vehicles	1 / Pack
822651	297	74	Landscape	No access for fork lift trucks and other industrial vehicles	1 / Pack
822653	450	150	Landscape	No access for fork lift trucks and other industrial vehicles	1 / Pack
822654	600	200	Landscape	No access for fork lift trucks and other industrial vehicles	1 / Pack
822647	148	210	Portrait	No access for fork lift trucks and other industrial vehicles	1 / Pack
822648	210	297	Portrait	No access for fork lift trucks and other industrial vehicles	1 / Pack
822652	297	105	Portrait	No access for fork lift trucks and other industrial vehicles	1 / Pack
822649	297	420	Portrait	No access for fork lift trucks and other industrial vehicles	1 / Pack

i For all material properties and applications, see pages 4-5

BRADY Customise-it See page 196 to order your custom-made signs.

Complies with EN ISO 7010

P007 : No access for people with active implanted cardiac devices

Certain environments and activities are prohibited for people wearing a pacemaker to preserve their safety. Pointing these out is therefore vital.



SIGNS

Order Ref.	Diameter (mm)	Total Qty/Pack
Laminated Polyester		
822739	50	2 / Pack
822741	100	1 / Pack
822742	200	1 / Pack
822743	315	1 / Pack
Polypropylene		
822745	100	1 / Pack
822746	200	1 / Pack
822747	315	1 / Pack
Aluminium		
822749	100	1 / Pack
822750	200	1 / Pack
822751	315	1 / Pack

FLOOR MARKING

Order Ref.	Diameter (mm)	Total Qty/Pack
Anti-skid Laminated Polyester		
822744	500	1 / Pack

MINI-PICTOGRAMS

Order Ref.	Diameter (mm)	Total Qty/Pack
Laminated Polyester		
822737	25	7 / Pack
Vinyl		
822735	15	54 / Pack



PICTOGRAMS ON ROLLS

Order Ref.	Diameter (mm)	Total Qty/Pack
Laminated Polyester		
822736	25	250 / Roll
822738	50	250 / Roll
822740	100	250 / Roll

SIGNS WITH TEXT



Order Ref.	Width (mm)	Height (mm)	Layout	Legend	Total Qty/Pack
Polypropylene					
822807	150	50	Land-scape	No access for people with active implanted cardiac devices	1 / Pack
822808	297	74	Land-scape	No access for people with active implanted cardiac devices	1 / Pack
822810	450	150	Land-scape	No access for people with active implanted cardiac devices	1 / Pack
822811	600	200	Land-scape	No access for people with active implanted cardiac devices	1 / Pack
822804	148	210	Portrait	No access for people with active implanted cardiac devices	1 / Pack
822805	210	297	Portrait	No access for people with active implanted cardiac devices	1 / Pack
822809	297	105	Portrait	No access for people with active implanted cardiac devices	1 / Pack
822806	297	420	Portrait	No access for people with active implanted cardiac devices	1 / Pack
Aluminium					
822815	150	50	Land-scape	No access for people with active implanted cardiac devices	1 / Pack
822817	450	150	Land-scape	No access for people with active implanted cardiac devices	1 / Pack
822812	148	210	Portrait	No access for people with active implanted cardiac devices	1 / Pack
822813	210	297	Portrait	No access for people with active implanted cardiac devices	1 / Pack
822816	297	105	Portrait	No access for people with active implanted cardiac devices	1 / Pack
822814	297	420	Portrait	No access for people with active implanted cardiac devices	1 / Pack
Laminated Polyester					
822799	150	50	Land-scape	No access for people with active implanted cardiac devices	1 / Pack
822800	297	74	Land-scape	No access for people with active implanted cardiac devices	1 / Pack
822802	450	150	Land-scape	No access for people with active implanted cardiac devices	1 / Pack
822803	600	200	Land-scape	No access for people with active implanted cardiac devices	1 / Pack
822796	148	210	Portrait	No access for people with active implanted cardiac devices	1 / Pack
822797	210	297	Portrait	No access for people with active implanted cardiac devices	1 / Pack
822801	297	105	Portrait	No access for people with active implanted cardiac devices	1 / Pack
822798	297	420	Portrait	No access for people with active implanted cardiac devices	1 / Pack

i For all material properties and applications, see pages 4-5

BRADY Customise-it See page 196 to order your custom-made signs.



PHOTOLUMINESCENT SIGNS

Order Ref.	Diameter (mm)	Class	Total Qty/Pack
Class B Photoluminescent Polyester			
835924	150	Class B	1 / Pack
Class C Photoluminescent Polyester			
835925	150	Class C	1 / Pack
Class B Photoluminescent Polypropylene			
835922	150	Class B	1 / Pack
Class C Photoluminescent Polypropylene			
835923	150	Class C	1 / Pack
Class C Photoluminescent Aluminium			
835921	150	Class C	1 / Pack



P008 : No METALLIC ARTICLES OR WATCHES

Metallic objects are sometimes banned, for example to ensure the correct operation of some machines.



SIGNS

Order Ref.	Diameter (mm)	Total Qty/Pack
Laminated Polyester		
822888	50	2 / Pack
822890	100	1 / Pack
822891	200	1 / Pack
822892	315	1 / Pack
Polypropylene		
822894	100	1 / Pack
822895	200	1 / Pack
822896	315	1 / Pack
Aluminium		
822898	100	1 / Pack
822899	200	1 / Pack
822900	315	1 / Pack

MINI-PICTOGRAMS

Order Ref.	Diameter (mm)	Total Qty/Pack
Laminated Polyester		
822886	25	7 / Pack
Vinyl		
822884	15	54 / Pack

SIGNS WITH TEXT



Order Ref.	Width (mm)	Height (mm)	Layout	Legend	Total Qty/Pack
Polypropylene					
822956	150	50	Landscape	No metallic articles or watches	1 / Pack
822957	297	74	Landscape	No metallic articles or watches	1 / Pack
822959	450	150	Landscape	No metallic articles or watches	1 / Pack
822960	600	200	Landscape	No metallic articles or watches	1 / Pack
822953	148	210	Portrait	No metallic articles or watches	1 / Pack
822954	210	297	Portrait	No metallic articles or watches	1 / Pack
822958	297	105	Portrait	No metallic articles or watches	1 / Pack
822955	297	420	Portrait	No metallic articles or watches	1 / Pack
Aluminium					
822964	150	50	Landscape	No metallic articles or watches	1 / Pack
822966	450	150	Landscape	No metallic articles or watches	1 / Pack
822961	148	210	Portrait	No metallic articles or watches	1 / Pack
822962	210	297	Portrait	No metallic articles or watches	1 / Pack
822965	297	105	Portrait	No metallic articles or watches	1 / Pack
822963	297	420	Portrait	No metallic articles or watches	1 / Pack
Laminated Polyester					
822948	150	50	Landscape	No metallic articles or watches	1 / Pack
822949	297	74	Landscape	No metallic articles or watches	1 / Pack
822951	450	150	Landscape	No metallic articles or watches	1 / Pack
822952	600	200	Landscape	No metallic articles or watches	1 / Pack
822945	148	210	Portrait	No metallic articles or watches	1 / Pack
822946	210	297	Portrait	No metallic articles or watches	1 / Pack
822950	297	105	Portrait	No metallic articles or watches	1 / Pack
822947	297	420	Portrait	No metallic articles or watches	1 / Pack



PICTOGRAMS ON ROLLS

Order Ref.	Diameter (mm)	Total Qty/Pack
Laminated Polyester		
822885	25	250 / Roll
822887	50	250 / Roll
822889	100	250 / Roll



PHOTOLUMINESCENT SIGNS

Order Ref.	Diameter (mm)	Class	Total Qty/Pack
Class B Photoluminescent Polyester			
835930	150	Class B	1 / Pack
Class C Photoluminescent Polyester			
835931	150	Class C	1 / Pack
Class B Photoluminescent Polypropylene			
835927	150	Class B	1 / Pack
Class C Photoluminescent Polypropylene			
835929	150	Class C	1 / Pack
Class C Photoluminescent Aluminium			
835926	150	Class C	1 / Pack

i For all material properties and applications, see pages 4-5

BRADY Customise-it See page 196 to order your custom-made signs.

Complies with EN ISO 7010

P009 : No CLIMBING

To avoid any falls or damage to equipment, a sign banning climbing must sometimes be put up.



SIGNS

Order Ref.	Diameter (mm)	Total Qty/Pack
Laminated Polyester		
135747	100	1 / Pack
135748	150	1 / Pack
135749	200	1 / Pack
138840	315	1 / Pack
Polypropylene		
135741	100	1 / Pack
135742	150	1 / Pack
135743	200	1 / Pack
138894	315	1 / Pack
Aluminium		
135744	100	1 / Pack
135745	150	1 / Pack
135746	200	1 / Pack



PHOTOLUMINESCENT SIGNS

Order Ref.	Diameter (mm)	Class	Total Qty/Pack
Class B Photoluminescent Polyester			
135756	100	Class B	1 / Pack
135757	150	Class B	1 / Pack
135758	200	Class B	1 / Pack
Class C Photoluminescent Polyester			
135765	100	Class C	1 / Pack
135766	150	Class C	1 / Pack
135767	200	Class C	1 / Pack
Class B Photoluminescent Polypropylene			
135750	100	Class B	1 / Pack
135751	150	Class B	1 / Pack
135752	200	Class B	1 / Pack
Class C Photoluminescent Polypropylene			
135759	100	Class C	1 / Pack
135760	150	Class C	1 / Pack
135761	200	Class C	1 / Pack
Class C Photoluminescent Aluminium			
135762	100	Class C	1 / Pack
135763	150	Class C	1 / Pack
135764	200	Class C	1 / Pack

Complies with EN ISO 7010

P010 : Do NOT TOUCH

Prohibiting touching can be indicated for various reasons: avoiding an injury, preventing fragile objects from being touched etc.



SIGNS

Order Ref.	Diameter (mm)	Total Qty/Pack
Laminated Polyester		
823037	50	2 / Pack
823039	100	1 / Pack
823040	200	1 / Pack
823041	315	1 / Pack
Polypropylene		
823043	100	1 / Pack
823044	200	1 / Pack
823045	315	1 / Pack
Aluminium		
823047	100	1 / Pack
823048	200	1 / Pack
823049	315	1 / Pack

SIGNS WITH TEXT



Order Ref.	Width (mm)	Height (mm)	Layout	Legend	Total Qty/Pack
Polypropylene					
823105	150	50	Landscape	Do not touch	1 / Pack
823106	297	74	Landscape	Do not touch	1 / Pack
823108	450	150	Landscape	Do not touch	1 / Pack
823109	600	200	Landscape	Do not touch	1 / Pack
823102	148	210	Portrait	Do not touch	1 / Pack
823103	210	297	Portrait	Do not touch	1 / Pack
823107	297	105	Portrait	Do not touch	1 / Pack
823104	297	420	Portrait	Do not touch	1 / Pack
Aluminium					
823113	150	50	Landscape	Do not touch	1 / Pack
823115	450	150	Landscape	Do not touch	1 / Pack
823110	148	210	Portrait	Do not touch	1 / Pack
823111	210	297	Portrait	Do not touch	1 / Pack
823114	297	105	Portrait	Do not touch	1 / Pack
823112	297	420	Portrait	Do not touch	1 / Pack
Laminated Polyester					
823097	150	50	Landscape	Do not touch	1 / Pack
823098	297	74	Landscape	Do not touch	1 / Pack
823100	450	150	Landscape	Do not touch	1 / Pack
823101	600	200	Landscape	Do not touch	1 / Pack
823094	148	210	Portrait	Do not touch	1 / Pack
823095	210	297	Portrait	Do not touch	1 / Pack
823099	297	105	Portrait	Do not touch	1 / Pack
823096	297	420	Portrait	Do not touch	1 / Pack

MINI-PICTOGRAMS

Order Ref.	Diameter (mm)	Total Qty/Pack
Laminated Polyester		
823035	25	7 / Pack
Vinyl		
823033	15	54 / Pack

PHOTOLUMINESCENT SIGNS

Order Ref.	Diameter (mm)	Class	Total Qty/Pack
Class B Photoluminescent Polyester			
835936	150	Class B	1 / Pack
Class C Photoluminescent Polyester			
835937	150	Class C	1 / Pack
Class B Photoluminescent Polypropylene			
835934	150	Class B	1 / Pack
Class C Photoluminescent Polypropylene			
835935	150	Class C	1 / Pack
Class C Photoluminescent Aluminium			
835933	150	Class C	1 / Pack



PICTOGRAMS ON ROLLS

Order Ref.	Diameter (mm)	Total Qty/Pack
Laminated Polyester		
823034	25	250 / Roll
823036	50	250 / Roll
823038	100	250 / Roll



P011 : Do NOT EXTINGUISH WITH WATER

Some fires must absolutely not be put out with water, at the risk of worsening the situation.



SIGNS

Order Ref.	Diameter (mm)	Total Qty/Pack
Laminated Polyester		
823186	50	2 / Pack
823188	100	1 / Pack
823189	200	1 / Pack
823190	315	1 / Pack
Polypropylene		
823192	100	1 / Pack
823193	200	1 / Pack
823194	315	1 / Pack
Aluminium		
823196	100	1 / Pack
823197	200	1 / Pack
823198	315	1 / Pack

FLOOR MARKING

Order Ref.	Diameter (mm)	Total Qty/Pack
Anti-skid Laminated Polyester		
823191	500	1 / Pack

MINI-PICTOGRAMS

Order Ref.	Diameter (mm)	Total Qty/Pack
Laminated Polyester		
823184	25	7 / Pack
Vinyl		
823182	15	54 / Pack

SIGNS WITH TEXT



Order Ref.	Width (mm)	Height (mm)	Layout	Legend	Total Qty/Pack
Polypropylene					
823254	150	50	Landscape	Do not extinguish with water	1 / Pack
823255	297	74	Landscape	Do not extinguish with water	1 / Pack
823257	450	150	Landscape	Do not extinguish with water	1 / Pack
823258	600	200	Landscape	Do not extinguish with water	1 / Pack
823251	148	210	Portrait	Do not extinguish with water	1 / Pack
823252	210	297	Portrait	Do not extinguish with water	1 / Pack
823256	297	105	Portrait	Do not extinguish with water	1 / Pack
823253	297	420	Portrait	Do not extinguish with water	1 / Pack
Aluminium					
823262	150	50	Landscape	Do not extinguish with water	1 / Pack
823264	450	150	Landscape	Do not extinguish with water	1 / Pack
823259	148	210	Portrait	Do not extinguish with water	1 / Pack
823260	210	297	Portrait	Do not extinguish with water	1 / Pack
823263	297	105	Portrait	Do not extinguish with water	1 / Pack
823261	297	420	Portrait	Do not extinguish with water	1 / Pack
Laminated Polyester					
823246	150	50	Landscape	Do not extinguish with water	1 / Pack
823247	297	74	Landscape	Do not extinguish with water	1 / Pack
823249	450	150	Landscape	Do not extinguish with water	1 / Pack
823250	600	200	Landscape	Do not extinguish with water	1 / Pack
823243	148	210	Portrait	Do not extinguish with water	1 / Pack
823244	210	297	Portrait	Do not extinguish with water	1 / Pack
823248	297	105	Portrait	Do not extinguish with water	1 / Pack
823245	297	420	Portrait	Do not extinguish with water	1 / Pack



PICTOGRAMS ON ROLLS

Order Ref.	Diameter (mm)	Total Qty/Pack
Laminated Polyester		
823183	25	250 / Roll
823185	50	250 / Roll
823187	100	250 / Roll



PHOTOLUMINESCENT SIGNS

Order Ref.	Diameter (mm)	Class	Total Qty/Pack
Class B Photoluminescent Polyester			
835941	150	Class B	1 / Pack
Class C Photoluminescent Polyester			
835942	150	Class C	1 / Pack
Class B Photoluminescent Polypropylene			
835939	150	Class B	1 / Pack
Class C Photoluminescent Polypropylene			
835940	150	Class C	1 / Pack
Class C Photoluminescent Aluminium			
835938	150	Class C	1 / Pack

i For all material properties and applications, see pages 4-5

BRADY Customise-it See page 196 to order your custom-made signs.

Complies with EN ISO 7010

P012 : No HEAVY LOAD

Placing heavy loads in unsuitable locations can have detrimental consequences. This symbol helps to avoid regrettable situations.



SIGNS

Order Ref.	Diameter (mm)	Total Qty/Pack
Laminated Polyester		
823335	50	2 / Pack
823337	100	1 / Pack
823338	200	1 / Pack
823339	315	1 / Pack
Polypropylene		
823341	100	1 / Pack
823342	200	1 / Pack
823343	315	1 / Pack
Aluminium		
823345	100	1 / Pack
823346	200	1 / Pack
823347	315	1 / Pack

MINI-PICTOGRAMS

Order Ref.	Diameter (mm)	Total Qty/Pack
Laminated Polyester		
823333	25	7 / Pack
138987	30	15 / Pack
Vinyl		
823331	15	54 / Pack



PICTOGRAMS ON ROLLS

Order Ref.	Diameter (mm)	Total Qty/Pack
Laminated Polyester		
823332	25	250 / Roll
823334	50	250 / Roll
823336	100	250 / Roll

SIGNS WITH TEXT



Order Ref.	Width (mm)	Height (mm)	Layout	Legend	Total Qty/Pack
Polypropylene					
823403	150	50	Landscape	No heavy load	1 / Pack
823404	297	74	Landscape	No heavy load	1 / Pack
823406	450	150	Landscape	No heavy load	1 / Pack
823407	600	200	Landscape	No heavy load	1 / Pack
823400	148	210	Portrait	No heavy load	1 / Pack
823401	210	297	Portrait	No heavy load	1 / Pack
823405	297	105	Portrait	No heavy load	1 / Pack
823402	297	420	Portrait	No heavy load	1 / Pack
Aluminium					
823411	150	50	Landscape	No heavy load	1 / Pack
823404	297	74	Landscape	No heavy load	1 / Pack
823408	148	210	Portrait	No heavy load	1 / Pack
823409	210	297	Portrait	No heavy load	1 / Pack
823412	297	105	Portrait	No heavy load	1 / Pack
823410	297	420	Portrait	No heavy load	1 / Pack
Laminated Polyester					
823395	150	50	Landscape	No heavy load	1 / Pack
823396	297	74	Landscape	No heavy load	1 / Pack
823398	450	150	Landscape	No heavy load	1 / Pack
823399	600	200	Landscape	No heavy load	1 / Pack
823392	148	210	Portrait	No heavy load	1 / Pack
823393	210	297	Portrait	No heavy load	1 / Pack
823397	297	105	Portrait	No heavy load	1 / Pack
823394	297	420	Portrait	No heavy load	1 / Pack



PHOTOLUMINESCENT SIGNS

Order Ref.	Diameter (mm)	Class	Total Qty/Pack
Class B Photoluminescent Polyester			
835946	150	Class B	1 / Pack
Class C Photoluminescent Polyester			
835952	150	Class C	1 / Pack
Class B Photoluminescent Polypropylene			
835944	150	Class B	1 / Pack
Class C Photoluminescent Polypropylene			
835945	150	Class C	1 / Pack
Class C Photoluminescent Aluminium			
835943	150	Class C	1 / Pack

i For all material properties and applications, see pages 4-5

BRADY Customise-it See page 196 to order your custom-made signs.



P013 : No ACTIVATED MOBILE PHONES

While mobile phones are omnipresent in everyone's daily life, using them may be prohibited in certain environments for various reasons.



SIGNS

Order Ref.	Diameter (mm)	Total Qty/ Pack
Laminated Polyester		
823484	50	2 / Pack
823486	100	1 / Pack
823487	200	1 / Pack
823488	315	1 / Pack
Polypropylene		
823490	100	1 / Pack
823491	200	1 / Pack
823492	315	1 / Pack
Aluminium		
823494	100	1 / Pack
823495	200	1 / Pack
823496	315	1 / Pack

FLOOR MARKING

Order Ref.	Diameter (mm)	Total Qty/ Pack
Anti-skid Laminated Polyester		
823489	500	1 / Pack

MINI-PICTOGRAMS

Order Ref.	Diameter (mm)	Total Qty/ Pack
Laminated Polyester		
823482	25	7 / Pack
Vinyl		
823480	15	54 / Pack

SIGNS WITH TEXT



Order Ref.	Width (mm)	Height (mm)	Layout	Legend	Total Qty/ Pack
Polypropylene					
823552	150	50	Landscape	No activated mobile phones	1 / Pack
823553	297	74	Landscape	No activated mobile phones	1 / Pack
823555	450	150	Landscape	No activated mobile phones	1 / Pack
823556	600	200	Landscape	No activated mobile phones	1 / Pack
823549	148	210	Portrait	No activated mobile phones	1 / Pack
823550	210	297	Portrait	No activated mobile phones	1 / Pack
823554	297	105	Portrait	No activated mobile phones	1 / Pack
823551	297	420	Portrait	No activated mobile phones	1 / Pack
Aluminium					
823560	150	50	Landscape	No activated mobile phones	1 / Pack
823562	450	150	Landscape	No activated mobile phones	1 / Pack
823557	148	210	Portrait	No activated mobile phones	1 / Pack
823558	210	297	Portrait	No activated mobile phones	1 / Pack
823561	297	105	Portrait	No activated mobile phones	1 / Pack
823559	297	420	Portrait	No activated mobile phones	1 / Pack
Laminated Polyester					
823544	150	50	Landscape	No activated mobile phones	1 / Pack
823545	297	74	Landscape	No activated mobile phones	1 / Pack
823547	450	150	Landscape	No activated mobile phones	1 / Pack
823548	600	200	Landscape	No activated mobile phones	1 / Pack
823541	148	210	Portrait	No activated mobile phones	1 / Pack
823542	210	297	Portrait	No activated mobile phones	1 / Pack
823546	297	105	Portrait	No activated mobile phones	1 / Pack
823543	297	420	Portrait	No activated mobile phones	1 / Pack



PICTOGRAMS ON ROLLS

Order Ref.	Diameter (mm)	Total Qty/ Pack
Laminated Polyester		
823481	25	250 / Roll
823483	50	250 / Roll
823485	100	250 / Roll



PHOTOLUMINESCENT SIGNS

Order Ref.	Diameter (mm)	Class	Total Qty/ Pack
Class B Photoluminescent Polyester			
835979	150	Class B	1 / Pack
836762	200	Class B	1 / Pack
Class C Photoluminescent Polyester			
835980	150	Class C	1 / Pack
Class B Photoluminescent Polypropylene			
835969	150	Class B	1 / Pack
836760	200	Class B	1 / Pack
836761	300	Class B	1 / Pack
Class C Photoluminescent Polypropylene			
835977	150	Class C	1 / Pack
Class C Photoluminescent Aluminium			
835968	150	Class C	1 / Pack

i For all material properties and applications, see pages 4-5

BRADY Customise-it See page 196 to order your custom-made signs.

Complies with EN ISO 7010

P014 : No Access for Persons with Metallic Implants

For their safety, persons with metallic implants may be banned from accessing certain areas. Pointing this out is therefore vital.



SIGNS

Order Ref.	Diameter (mm)	Total Qty/Pack
Laminated Polyester		
823633	50	2 / Pack
823635	100	1 / Pack
823636	200	1 / Pack
823637	315	1 / Pack
Polypropylene		
823639	100	1 / Pack
823640	200	1 / Pack
823641	315	1 / Pack
Aluminium		
823643	100	1 / Pack
823644	200	1 / Pack
823645	315	1 / Pack

FLOOR MARKING

Order Ref.	Diameter (mm)	Total Qty/Pack
Anti-skid Laminated Polyester		
823638	500	1 / Pack

MINI-PICTOGRAMS

Order Ref.	Diameter (mm)	Total Qty/Pack
Laminated Polyester		
823631	25	7 / Pack
Vinyl		
823629	15	54 / Pack



PICTOGRAMS ON ROLLS

Order Ref.	Diameter (mm)	Total Qty/Pack
Laminated Polyester		
823630	25	250 / Roll
823632	50	250 / Roll
823634	100	250 / Roll



PHOTOLUMINESCENT SIGNS

Order Ref.	Diameter (mm)	Class	Total Qty/Pack
Class B Photoluminescent Polyester			
835985	150	Class B	1 / Pack
Class C Photoluminescent Polyester			
835986	150	Class C	1 / Pack
Class B Photoluminescent Polypropylene			
835982	150	Class B	1 / Pack
Class C Photoluminescent Polypropylene			
835984	150	Class C	1 / Pack
Class C Photoluminescent Aluminium			
835981	150	Class C	1 / Pack

SIGNS WITH TEXT



Order Ref.	Width (mm)	Height (mm)	Layout	Legend	Total Qty/Pack
Polypropylene					
823701	150	50	Landscape	No access for persons with metallic implants	1 / Pack
823702	297	74	Landscape	No access for persons with metallic implants	1 / Pack
823704	450	150	Landscape	No access for persons with metallic implants	1 / Pack
823705	600	200	Landscape	No access for persons with metallic implants	1 / Pack
823698	148	210	Portrait	No access for persons with metallic implants	1 / Pack
823699	210	297	Portrait	No access for persons with metallic implants	1 / Pack
823703	297	105	Portrait	No access for persons with metallic implants	1 / Pack
823700	297	420	Portrait	No access for persons with metallic implants	1 / Pack
Aluminium					
823709	150	50	Landscape	No access for persons with metallic implants	1 / Pack
823711	450	150	Landscape	No access for persons with metallic implants	1 / Pack
823706	148	210	Portrait	No access for persons with metallic implants	1 / Pack
823707	210	297	Portrait	No access for persons with metallic implants	1 / Pack
823710	297	105	Portrait	No access for persons with metallic implants	1 / Pack
823708	297	420	Portrait	No access for persons with metallic implants	1 / Pack
Laminated Polyester					
823693	150	50	Landscape	No access for persons with metallic implants	1 / Pack
823694	297	74	Landscape	No access for persons with metallic implants	1 / Pack
823696	450	150	Landscape	No access for persons with metallic implants	1 / Pack
823697	600	200	Landscape	No access for persons with metallic implants	1 / Pack
823690	148	210	Portrait	No access for persons with metallic implants	1 / Pack
823691	210	297	Portrait	No access for persons with metallic implants	1 / Pack
823695	297	105	Portrait	No access for persons with metallic implants	1 / Pack
823692	297	420	Portrait	No access for persons with metallic implants	1 / Pack

i For all material properties and applications, see pages 4-5

BRADY Customise-it See page 196 to order your custom-made signs.



P015 : No REACHING IN

To avoid an accident, indicating in specific locations that hands must be kept clear may be important.



SIGNS

Order Ref.	Diameter (mm)	Total Qty/Pack
Laminated Polyester		
823782	50	2 / Pack
823784	100	1 / Pack
823785	200	1 / Pack
823786	315	1 / Pack
Polypropylene		
823788	100	1 / Pack
823789	200	1 / Pack
823790	315	1 / Pack
Aluminium		
823792	100	1 / Pack
823793	200	1 / Pack
823794	315	1 / Pack

FLOOR MARKING

Order Ref.	Diameter (mm)	Total Qty/Pack
Anti-skid Laminated Polyester		
823787	500	1 / Pack

MINI-PICTOGRAMS

Order Ref.	Diameter (mm)	Total Qty/Pack
Laminated Polyester		
138984	10	54 / Pack
823780	25	7 / Pack
138985	30	15 / Pack
Vinyl		
823778	15	54 / Pack

SIGNS WITH TEXT



Order Ref.	Width (mm)	Height (mm)	Layout	Legend	Total Qty/Pack
Polypropylene					
823850	150	50	Landscape	No reaching in	1 / Pack
823851	297	74	Landscape	No reaching in	1 / Pack
823853	450	150	Landscape	No reaching in	1 / Pack
823854	600	200	Landscape	No reaching in	1 / Pack
823847	148	210	Portrait	No reaching in	1 / Pack
823848	210	297	Portrait	No reaching in	1 / Pack
823852	297	105	Portrait	No reaching in	1 / Pack
823849	297	420	Portrait	No reaching in	1 / Pack
Aluminium					
823858	150	50	Landscape	No reaching in	1 / Pack
823860	450	150	Landscape	No reaching in	1 / Pack
823855	148	210	Portrait	No reaching in	1 / Pack
823856	210	297	Portrait	No reaching in	1 / Pack
823859	297	105	Portrait	No reaching in	1 / Pack
823857	297	420	Portrait	No reaching in	1 / Pack
Laminated Polyester					
823842	150	50	Landscape	No reaching in	1 / Pack
823843	297	74	Landscape	No reaching in	1 / Pack
823845	450	150	Landscape	No reaching in	1 / Pack
823846	600	200	Landscape	No reaching in	1 / Pack
823839	148	210	Portrait	No reaching in	1 / Pack
823840	210	297	Portrait	No reaching in	1 / Pack
823844	297	105	Portrait	No reaching in	1 / Pack
823841	297	420	Portrait	No reaching in	1 / Pack



PICTOGRAMS ON ROLLS

Order Ref.	Diameter (mm)	Total Qty/Pack
Laminated Polyester		
823779	25	250 / Roll
823781	50	250 / Roll
823783	100	250 / Roll



PHOTOLUMINESCENT SIGNS

Order Ref.	Diameter (mm)	Class	Total Qty/Pack
Class B Photoluminescent Polyester			
835994	150	Class B	1 / Pack
Class C Photoluminescent Polyester			
835995	150	Class C	1 / Pack
Class B Photoluminescent Polypropylene			
835988	150	Class B	1 / Pack
Class C Photoluminescent Polypropylene			
835992	150	Class C	1 / Pack
Class C Photoluminescent Aluminium			
835987	150	Class C	1 / Pack

i For all material properties and applications, see pages 4-5

BRADY Customise-it See page 196 to order your custom-made signs.

Complies with EN ISO 7010

P016 : Do NOT SPRAY WITH WATER

To avoid any damage, spraying some components with water may be prohibited.



SIGNS

Order Ref.	Diameter (mm)	Total Qty/Pack
Laminated Polyester		
831087	50	2 / Pack
831089	100	1 / Pack
831090	200	1 / Pack
831091	315	1 / Pack
Polypropylene		
831093	100	1 / Pack
831094	200	1 / Pack
831095	315	1 / Pack
831096	400	1 / Pack
Aluminium		
831097	100	1 / Pack
831098	200	1 / Pack
831099	315	1 / Pack

FLOOR MARKING

Order Ref.	Diameter (mm)	Total Qty/Pack
Anti-skid Laminated Polyester		
831092	500	1 / Pack

MINI-PICTOGRAMS

Order Ref.	Diameter (mm)	Total Qty/Pack
Laminated Polyester		
138981	20	18 / Pack
831085	25	7 / Pack
Vinyl		
831083	15	54 / Pack



PICTOGRAMS ON ROLLS

Order Ref.	Diameter (mm)	Total Qty/Pack
Laminated Polyester		
831084	25	250 / Roll
831086	50	250 / Roll
831088	100	250 / Roll



PHOTOLUMINESCENT SIGNS

Order Ref.	Diameter (mm)	Class	Total Qty/Pack
Class B Photoluminescent Polyester			
835999	150	Class B	1 / Pack
Class C Photoluminescent Polyester			
836011	150	Class C	1 / Pack
Class B Photoluminescent Polypropylene			
835997	150	Class B	1 / Pack
Class C Photoluminescent Polypropylene			
835998	150	Class C	1 / Pack
Class C Photoluminescent Aluminium			
835996	150	Class C	1 / Pack

i For all material properties and applications, see pages 4-5

BRADY Customise-it See page 196 to order your custom-made signs.

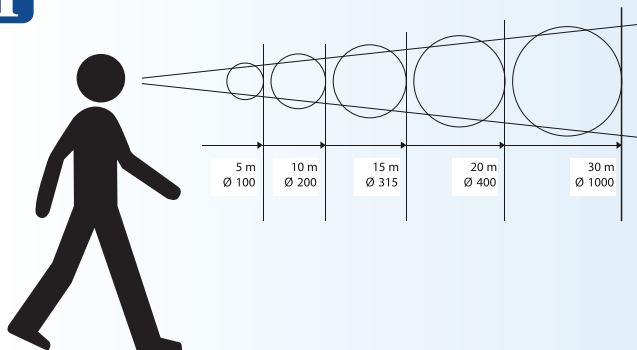

READING DISTANCE

Sign sizes depend on reading distance. The diagram opposite allows you to ensure that dimensions of a pictogram meet European Directives as closely as possible. Photoluminescent signs must be used where natural lighting is inadequate (especially to mark exits and emergency exits).



P017 : No PUSHING

Faced with a fragile structure, it is sometimes important to point out that pushing is banned.



SIGNS

Order Ref.	Diameter (mm)	Total Qty/Pack
Laminated Polyester		
823931	50	2 / Pack
823933	100	1 / Pack
823934	200	1 / Pack
823935	315	1 / Pack
Polypropylene		
823937	100	1 / Pack
823938	200	1 / Pack
823939	315	1 / Pack
Aluminium		
823941	100	1 / Pack
823942	200	1 / Pack
823943	315	1 / Pack

FLOOR MARKING

Order Ref.	Diameter (mm)	Total Qty/Pack
Anti-skid Laminated Polyester		
823936	500	1 / Pack

MINI-PICTOGRAMS

Order Ref.	Diameter (mm)	Total Qty/Pack
Laminated Polyester		
138986	20	18 / Pack
823929	25	7 / Pack
Vinyl		
823927	15	54 / Pack

SIGNS WITH TEXT



Order Ref.	Width (mm)	Height (mm)	Layout	Legend	Total Qty/Pack
Polypropylene					
823999	150	50	Landscape	No pushing	1 / Pack
824000	297	74	Landscape	No pushing	1 / Pack
824002	450	150	Landscape	No pushing	1 / Pack
824003	600	200	Landscape	No pushing	1 / Pack
823996	148	210	Portrait	No pushing	1 / Pack
823997	210	297	Portrait	No pushing	1 / Pack
824001	297	105	Portrait	No pushing	1 / Pack
823998	297	420	Portrait	No pushing	1 / Pack
Aluminium					
824007	150	50	Landscape	No pushing	1 / Pack
824009	450	150	Landscape	No pushing	1 / Pack
824004	148	210	Portrait	No pushing	1 / Pack
824005	210	297	Portrait	No pushing	1 / Pack
824008	297	105	Portrait	No pushing	1 / Pack
824006	297	420	Portrait	No pushing	1 / Pack
Laminated Polyester					
823991	150	50	Landscape	No pushing	1 / Pack
823992	297	74	Landscape	No pushing	1 / Pack
823994	450	150	Landscape	No pushing	1 / Pack
823995	600	200	Landscape	No pushing	1 / Pack
823988	148	210	Portrait	No pushing	1 / Pack
823989	210	297	Portrait	No pushing	1 / Pack
823993	297	105	Portrait	No pushing	1 / Pack
823990	297	420	Portrait	No pushing	1 / Pack



PICTOGRAMS ON ROLLS

Order Ref.	Diameter (mm)	Total Qty/Pack
Laminated Polyester		
823928	25	250 / Roll
823930	50	250 / Roll
823932	100	250 / Roll



PHOTOLUMINESCENT SIGNS

Order Ref.	Diameter (mm)	Class	Total Qty/Pack
Class B Photoluminescent Polyester			
836023	150	Class B	1 / Pack
Class C Photoluminescent Polyester			
836024	150	Class C	1 / Pack
Class B Photoluminescent Polypropylene			
836016	150	Class B	1 / Pack
Class C Photoluminescent Polypropylene			
836022	150	Class C	1 / Pack
Class C Photoluminescent Aluminium			
836013	150	Class C	1 / Pack

i For all material properties and applications, see pages 4-5

BRADY Customise-it See page 196 to order your custom-made signs.

Complies with EN ISO 7010

P018 : No SITTING

As much to avoid damage as to avoid an injury, specifying that sitting down is prohibited may be necessary.



SIGNS

Order Ref.	Diameter (mm)	Total Qty/Pack
Laminated Polyester		
824080	50	2 / Pack
824082	100	1 / Pack
824083	200	1 / Pack
824084	315	1 / Pack
Polypropylene		
824086	100	1 / Pack
824087	200	1 / Pack
824088	315	1 / Pack
Aluminium		
824090	100	1 / Pack
824091	200	1 / Pack
824092	315	1 / Pack

FLOOR MARKING

Order Ref.	Diameter (mm)	Total Qty/Pack
Anti-skid Laminated Polyester		
824085	500	1 / Pack

MINI-PICTOGRAMS

Order Ref.	Diameter (mm)	Total Qty/Pack
Laminated Polyester		
824078	25	7 / Pack
Vinyl		
824076	15	54 / Pack

SIGNS WITH TEXT



Order Ref.	Width (mm)	Height (mm)	Layout	Legend	Total Qty/Pack
Polypropylene					
824148	150	50	Landscape	No sitting	1 / Pack
824149	297	74	Landscape	No sitting	1 / Pack
824151	450	150	Landscape	No sitting	1 / Pack
824152	600	200	Landscape	No sitting	1 / Pack
824145	148	210	Portrait	No sitting	1 / Pack
824146	210	297	Portrait	No sitting	1 / Pack
824150	297	105	Portrait	No sitting	1 / Pack
824147	297	420	Portrait	No sitting	1 / Pack
Aluminium					
824156	150	50	Landscape	No sitting	1 / Pack
824158	450	150	Landscape	No sitting	1 / Pack
824153	148	210	Portrait	No sitting	1 / Pack
824154	210	297	Portrait	No sitting	1 / Pack
824157	297	105	Portrait	No sitting	1 / Pack
824155	297	420	Portrait	No sitting	1 / Pack
Laminated Polyester					
824140	150	50	Landscape	No sitting	1 / Pack
824141	297	74	Landscape	No sitting	1 / Pack
824143	450	150	Landscape	No sitting	1 / Pack
824144	600	200	Landscape	No sitting	1 / Pack
824137	148	210	Portrait	No sitting	1 / Pack
824138	210	297	Portrait	No sitting	1 / Pack
824142	297	105	Portrait	No sitting	1 / Pack
824139	297	420	Portrait	No sitting	1 / Pack



PICTOGRAMS ON ROLLS

Order Ref.	Diameter (mm)	Total Qty/Pack
Laminated Polyester		
824077	25	250 / Roll
824079	50	250 / Roll
824081	100	250 / Roll



PHOTOLUMINESCENT SIGNS

Order Ref.	Diameter (mm)	Class	Total Qty/Pack
Class B Photoluminescent Polyester			
836028	150	Class B	1 / Pack
Class C Photoluminescent Polyester			
836029	150	Class C	1 / Pack
Class B Photoluminescent Polypropylene			
836026	150	Class B	1 / Pack
Class C Photoluminescent Polypropylene			
836027	150	Class C	1 / Pack
Class C Photoluminescent Aluminium			
836025	150	Class C	1 / Pack

i For all material properties and applications, see pages 4-5

BRADY Customise-it See page 196 to order your custom-made signs.



P019 : No STEPPING ON SURFACE

In the case of a fragile structure or sometimes when carrying out work, specifying a ban on walking on this surface may be necessary.



SIGNS

Order Ref.	Diameter (mm)	Total Qty/Pack
Laminated Polyester		
824229	50	2 / Pack
824231	100	1 / Pack
824232	200	1 / Pack
824233	315	1 / Pack
Polypropylene		
824235	100	1 / Pack
824236	200	1 / Pack
824237	315	1 / Pack
Aluminium		
824239	100	1 / Pack
824240	200	1 / Pack
824241	315	1 / Pack

FLOOR MARKING

Order Ref.	Diameter (mm)	Total Qty/Pack
Anti-skid Laminated Polyester		
824234	500	1 / Pack

MINI-PICTOGRAMS

Order Ref.	Diameter (mm)	Total Qty/Pack
Laminated Polyester		
824227	25	7 / Pack
Vinyl		
824225	15	54 / Pack

SIGNS WITH TEXT



Order Ref.	Width (mm)	Height (mm)	Layout	Legend	Total Qty/Pack
Polypropylene					
824297	150	50	Landscape	No stepping on surface	1 / Pack
824298	297	74	Landscape	No stepping on surface	1 / Pack
824300	450	150	Landscape	No stepping on surface	1 / Pack
824301	600	200	Landscape	No stepping on surface	1 / Pack
824294	148	210	Portrait	No stepping on surface	1 / Pack
824295	210	297	Portrait	No stepping on surface	1 / Pack
824299	297	105	Portrait	No stepping on surface	1 / Pack
824296	297	420	Portrait	No stepping on surface	1 / Pack
Aluminium					
824305	150	50	Landscape	No stepping on surface	1 / Pack
824307	450	150	Landscape	No stepping on surface	1 / Pack
824302	148	210	Portrait	No stepping on surface	1 / Pack
824303	210	297	Portrait	No stepping on surface	1 / Pack
824306	297	105	Portrait	No stepping on surface	1 / Pack
824304	297	420	Portrait	No stepping on surface	1 / Pack
Laminated Polyester					
824289	150	50	Landscape	No stepping on surface	1 / Pack
824290	297	74	Landscape	No stepping on surface	1 / Pack
824292	450	150	Landscape	No stepping on surface	1 / Pack
824293	600	200	Landscape	No stepping on surface	1 / Pack
824286	148	210	Portrait	No stepping on surface	1 / Pack
824287	210	297	Portrait	No stepping on surface	1 / Pack
824291	297	105	Portrait	No stepping on surface	1 / Pack
824288	297	420	Portrait	No stepping on surface	1 / Pack



PICTOGRAMS ON ROLLS

Order Ref.	Diameter (mm)	Total Qty/Pack
Laminated Polyester		
824226	25	250 / Roll
824228	50	250 / Roll
824230	100	250 / Roll



PHOTOLUMINESCENT SIGNS

Order Ref.	Diameter (mm)	Class	Total Qty/Pack
Class B Photoluminescent Polyester			
836033	150	Class B	1 / Pack
Class C Photoluminescent Polyester			
836034	150	Class C	1 / Pack
Class B Photoluminescent Polypropylene			
836031	150	Class B	1 / Pack
Class C Photoluminescent Polypropylene			
836032	150	Class C	1 / Pack
Class C Photoluminescent Aluminium			
836030	150	Class C	1 / Pack

i For all material properties and applications, see pages 4-5

BRADY Customise-it See page 196 to order your custom-made signs.

Complies with EN ISO 7010

P020 : Do NOT USE LIFT IN THE EVENT OF FIRE

Taking a lift in the event of a fire can be extremely dangerous, this ban must therefore be made very visible to avoid people becoming trapped inside.



SIGNS

Order Ref.	Diameter (mm)	Total Qty/Pack
Laminated Polyester		
824378	50	2 / Pack
824380	100	1 / Pack
824381	200	1 / Pack
824382	315	1 / Pack
Polypropylene		
824384	100	1 / Pack
824385	200	1 / Pack
824386	315	1 / Pack
Aluminium		
824388	100	1 / Pack
824389	200	1 / Pack
824390	315	1 / Pack

FLOOR MARKING

Order Ref.	Diameter (mm)	Total Qty/Pack
Anti-skid Laminated Polyester		
824383	500	1 / Pack

MINI-PICTOGRAMS

Order Ref.	Diameter (mm)	Total Qty/Pack
Laminated Polyester		
824376	25	7 / Pack
Vinyl		
824374	15	54 / Pack



PICTOGRAMS ON ROLLS

Order Ref.	Diameter (mm)	Total Qty/Pack
Laminated Polyester		
824375	25	250 / Roll
824377	50	250 / Roll
824379	100	250 / Roll



PHOTOLUMINESCENT SIGNS WITH TEXT

Order Ref.	Width (mm)	Height (mm)	Class	Legend	Total Qty/Pack
Class B Photoluminescent Polyester					
836039	300	300	Class B	In the event of fire do not use this lift	1 / Pack
836038	250	100	Class B	In the event of fire do not use this lift	1 / Pack
Class B Photoluminescent Polypropylene					
836037	300	300	Class B	In the event of fire do not use this lift	1 / Pack
836036	250	100	Class B	In the event of fire do not use this lift	1 / Pack
Class C Photoluminescent Aluminium					
836035	100	100	Class C	In the event of fire do not use this lift	1 / Pack

SIGNS WITH TEXT



Order Ref.	Width (mm)	Height (mm)	Layout	Legend	Total Qty/Pack
Polypropylene					
824446	150	50	Landscape	Do not use lift in the event of fire	1 / Pack
824447	297	74	Landscape	Do not use lift in the event of fire	1 / Pack
824449	450	150	Landscape	Do not use lift in the event of fire	1 / Pack
824450	600	200	Landscape	Do not use lift in the event of fire	1 / Pack
824443	148	210	Portrait	Do not use lift in the event of fire	1 / Pack
824444	210	297	Portrait	Do not use lift in the event of fire	1 / Pack
824448	297	105	Portrait	Do not use lift in the event of fire	1 / Pack
824445	297	420	Portrait	Do not use lift in the event of fire	1 / Pack
Aluminium					
824454	150	50	Landscape	Do not use lift in the event of fire	1 / Pack
824456	450	150	Landscape	Do not use lift in the event of fire	1 / Pack
824451	148	210	Portrait	Do not use lift in the event of fire	1 / Pack
824452	210	297	Portrait	Do not use lift in the event of fire	1 / Pack
824455	297	105	Portrait	Do not use lift in the event of fire	1 / Pack
824453	297	420	Portrait	Do not use lift in the event of fire	1 / Pack
Laminated Polyester					
824438	150	50	Landscape	Do not use lift in the event of fire	1 / Pack
824439	297	74	Landscape	Do not use lift in the event of fire	1 / Pack
824441	450	150	Landscape	Do not use lift in the event of fire	1 / Pack
824442	600	200	Landscape	Do not use lift in the event of fire	1 / Pack
824435	148	210	Portrait	Do not use lift in the event of fire	1 / Pack
824436	210	297	Portrait	Do not use lift in the event of fire	1 / Pack
824440	297	105	Portrait	Do not use lift in the event of fire	1 / Pack
824437	297	420	Portrait	Do not use lift in the event of fire	1 / Pack

i For all material properties and applications, see pages 4-5

BRADY Customise-it See page 196 to order your custom-made signs.



P021 : No dogs

Dogs may be prohibited in certain places, this symbol therefore clarifies this ban. However, guide dogs or service dogs are often exempt from this ban. It is therefore appreciated if this is indicated.



SIGNS

Order Ref.	Diameter (mm)	Total Qty/Pack
Laminated Polyester		
824527	50	2 / Pack
824529	100	1 / Pack
824530	200	1 / Pack
824531	315	1 / Pack
Polypropylene		
824533	100	1 / Pack
824534	200	1 / Pack
824535	315	1 / Pack
824536	400	1 / Pack
Aluminium		
824537	100	1 / Pack
824538	200	1 / Pack
824539	315	1 / Pack

FLOOR MARKING

Order Ref.	Diameter (mm)	Total Qty/Pack
Anti-skid Laminated Polyester		
824532	500	1 / Pack

MINI-PICTOGRAMS

Order Ref.	Diameter (mm)	Total Qty/Pack
Laminated Polyester		
824525	25	7 / Pack
Vinyl		
824523	15	54 / Pack



PICTOGRAMS ON ROLLS

Order Ref.	Diameter (mm)	Total Qty/Pack
Laminated Polyester		
824524	25	250 / Roll
824526	50	250 / Roll
824528	100	250 / Roll

SIGNS WITH TEXT



Order Ref.	Width (mm)	Height (mm)	Layout	Legend	Total Qty/Pack
Polypropylene					
824595	150	50	Landscape	No dogs	1 / Pack
824596	297	74	Landscape	No dogs	1 / Pack
824598	450	150	Landscape	No dogs	1 / Pack
824599	600	200	Landscape	No dogs	1 / Pack
824592	148	210	Portrait	No dogs	1 / Pack
824593	210	297	Portrait	No dogs	1 / Pack
824597	297	105	Portrait	No dogs	1 / Pack
824594	297	420	Portrait	No dogs	1 / Pack
Aluminium					
824603	150	50	Landscape	No dogs	1 / Pack
824605	450	150	Landscape	No dogs	1 / Pack
824600	148	210	Portrait	No dogs	1 / Pack
824601	210	297	Portrait	No dogs	1 / Pack
824604	297	105	Portrait	No dogs	1 / Pack
824602	297	420	Portrait	No dogs	1 / Pack
Laminated Polyester					
824587	150	50	Landscape	No dogs	1 / Pack
824588	297	74	Landscape	No dogs	1 / Pack
824590	450	150	Landscape	No dogs	1 / Pack
824591	600	200	Landscape	No dogs	1 / Pack
824584	148	210	Portrait	No dogs	1 / Pack
824585	210	297	Portrait	No dogs	1 / Pack
824589	297	105	Portrait	No dogs	1 / Pack
824586	297	420	Portrait	No dogs	1 / Pack



PHOTOLUMINESCENT SIGNS

Order Ref.	Diameter (mm)	Class	Total Qty/Pack
Class B Photoluminescent Polyester			
836044	150	Class B	1 / Pack
Class C Photoluminescent Polyester			
836045	150	Class C	1 / Pack
Class B Photoluminescent Polypropylene			
836042	150	Class B	1 / Pack
Class C Photoluminescent Polypropylene			
836043	150	Class C	1 / Pack
Class C Photoluminescent Aluminium			
836041	150	Class C	1 / Pack

Complies with EN ISO 7010

P022 : No EATING OR DRINKING

Eating or drinking in certain places may be prohibited. This must therefore be clearly indicated.



SIGNS

Order Ref.	Diameter (mm)	Total Qty/Pack
Laminated Polyester		
824676	50	2 / Pack
824678	100	1 / Pack
824679	200	1 / Pack
824680	315	1 / Pack
Polypropylene		
824682	100	1 / Pack
824683	200	1 / Pack
824684	315	1 / Pack
Aluminium		
824686	100	1 / Pack
824687	200	1 / Pack
824688	315	1 / Pack

FLOOR MARKING

Order Ref.	Diameter (mm)	Total Qty/Pack
Anti-skid Laminated Polyester		
824681	500	1 / Pack

MINI-PICTOGRAMS

Order Ref.	Diameter (mm)	Total Qty/Pack
Laminated Polyester		
824674	25	7 / Pack
Vinyl		
824672	15	54 / Pack



SIGNS WITH TEXT



Order Ref.	Width (mm)	Height (mm)	Layout	Legend	Total Qty/ Pack
Polypropylene					
824744	150	50	Landscape	No eating or drinking	1 / Pack
824745	297	74	Landscape	No eating or drinking	1 / Pack
824747	450	150	Landscape	No eating or drinking	1 / Pack
824748	600	200	Landscape	No eating or drinking	1 / Pack
824741	148	210	Portrait	No eating or drinking	1 / Pack
824742	210	297	Portrait	No eating or drinking	1 / Pack
824746	297	105	Portrait	No eating or drinking	1 / Pack
824743	297	420	Portrait	No eating or drinking	1 / Pack
Aluminium					
824752	150	50	Landscape	No eating or drinking	1 / Pack
824754	450	150	Landscape	No eating or drinking	1 / Pack
824749	148	210	Portrait	No eating or drinking	1 / Pack
824750	210	297	Portrait	No eating or drinking	1 / Pack
824753	297	105	Portrait	No eating or drinking	1 / Pack
824751	297	420	Portrait	No eating or drinking	1 / Pack
Laminated Polyester					
824736	150	50	Landscape	No eating or drinking	1 / Pack
824737	297	74	Landscape	No eating or drinking	1 / Pack
824739	450	150	Landscape	No eating or drinking	1 / Pack
824740	600	200	Landscape	No eating or drinking	1 / Pack
824733	148	210	Portrait	No eating or drinking	1 / Pack
824734	210	297	Portrait	No eating or drinking	1 / Pack
824738	297	105	Portrait	No eating or drinking	1 / Pack
824735	297	420	Portrait	No eating or drinking	1 / Pack



PICTOGRAMS ON ROLLS

Order Ref.	Diameter (mm)	Total Qty/Pack
Laminated Polyester		
824673	25	250 / Roll
824675	50	250 / Roll
824677	100	250 / Roll



PHOTOLUMINESCENT SIGNS

Order Ref.	Diameter (mm)	Class	Total Qty/ Pack
Class B Photoluminescent Polyester			
836051	150	Class B	1 / Pack
Class C Photoluminescent Polyester			
836053	150	Class C	1 / Pack
Class B Photoluminescent Polypropylene			
836049	150	Class B	1 / Pack
Class C Photoluminescent Polypropylene			
836050	150	Class C	1 / Pack
Class C Photoluminescent Aluminium			
836048	150	Class C	1 / Pack

i For all material properties and applications, see pages 4-5

BRADY Customise-it See page 196 to order your custom-made signs.

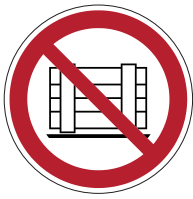

P023 : Do NOT OBSTRUCT

Not obstructing certain zones allows an emergency exit to be left clear.



SIGNS

Order Ref.	Diameter (mm)	Total Qty/Pack
Laminated Polyester		
824825	50	2 / Pack
824827	100	1 / Pack
824828	200	1 / Pack
824829	315	1 / Pack
Polypropylene		
824831	100	1 / Pack
824832	200	1 / Pack
824833	315	1 / Pack
Aluminium		
824835	100	1 / Pack
824836	200	1 / Pack
824837	315	1 / Pack

FLOOR MARKING

Order Ref.	Diameter (mm)	Total Qty/Pack
Anti-skid Laminated Polyester		
824830	500	1 / Pack

MINI-PICTOGRAMS

Order Ref.	Diameter (mm)	Total Qty/Pack
Laminated Polyester		
824823	25	7 / Pack
Vinyl		
824821	15	54 / Pack

SIGNS WITH TEXT



Order Ref.	Width (mm)	Height (mm)	Layout	Legend	Total Qty/Pack
Polypropylene					
824893	150	50	Landscape	Do not obstruct	1 / Pack
824894	297	74	Landscape	Do not obstruct	1 / Pack
824896	450	150	Landscape	Do not obstruct	1 / Pack
824897	600	200	Landscape	Do not obstruct	1 / Pack
824890	148	210	Portrait	Do not obstruct	1 / Pack
824891	210	297	Portrait	Do not obstruct	1 / Pack
824895	297	105	Portrait	Do not obstruct	1 / Pack
824892	297	420	Portrait	Do not obstruct	1 / Pack
Aluminium					
824901	150	50	Landscape	Do not obstruct	1 / Pack
824903	450	150	Landscape	Do not obstruct	1 / Pack
824898	148	210	Portrait	Do not obstruct	1 / Pack
824899	210	297	Portrait	Do not obstruct	1 / Pack
824902	297	105	Portrait	Do not obstruct	1 / Pack
824900	297	420	Portrait	Do not obstruct	1 / Pack
Laminated Polyester					
824885	150	50	Landscape	Do not obstruct	1 / Pack
824886	297	74	Landscape	Do not obstruct	1 / Pack
824888	450	150	Landscape	Do not obstruct	1 / Pack
824889	600	200	Landscape	Do not obstruct	1 / Pack
824882	148	210	Portrait	Do not obstruct	1 / Pack
824883	210	297	Portrait	Do not obstruct	1 / Pack
824887	297	105	Portrait	Do not obstruct	1 / Pack
824884	297	420	Portrait	Do not obstruct	1 / Pack



PICTOGRAMS ON ROLLS

Order Ref.	Diameter (mm)	Total Qty/Pack
Laminated Polyester		
824822	25	250 / Roll
824824	50	250 / Roll
824826	100	250 / Roll



PHOTOLUMINESCENT SIGNS

Order Ref.	Diameter (mm)	Class	Total Qty/Pack
Class B Photoluminescent Polyester			
836057	150	Class B	1 / Pack
Class C Photoluminescent Polyester			
836058	150	Class C	1 / Pack
Class B Photoluminescent Polypropylene			
836055	150	Class B	1 / Pack
Class C Photoluminescent Polypropylene			
836056	150	Class C	1 / Pack
Class C Photoluminescent Aluminium			
836054	150	Class C	1 / Pack

i For all material properties and applications, see pages 4-5

BRADY Customise-it See page 196 to order your custom-made signs.

Complies with EN ISO 7010

P024 : Do NOT WALK OR STAND HERE

Advising that walking and standing are prohibited may be important for the safety of pedestrians.



SIGNS

Order Ref.	Diameter (mm)	Total Qty/Pack
Laminated Polyester		
824974	50	2 / Pack
824976	100	1 / Pack
824977	200	1 / Pack
824978	315	1 / Pack
Polypropylene		
824980	100	1 / Pack
824981	200	1 / Pack
824982	315	1 / Pack
824983	400	1 / Pack
Aluminium		
824984	100	1 / Pack
824985	200	1 / Pack
824986	315	1 / Pack

FLOOR MARKING

Order Ref.	Diameter (mm)	Total Qty/Pack
Anti-skid Laminated Polyester		
824979	500	1 / Pack

MINI-PICTOGRAMS

Order Ref.	Diameter (mm)	Total Qty/Pack
Laminated Polyester		
824972	25	7 / Pack
Vinyl		
824970	15	54 / Pack

SIGNS WITH TEXT



Order Ref.	Width (mm)	Height (mm)	Layout	Legend	Total Qty/Pack
Polypropylene					
825042	150	50	Landscape	Do not walk or stand here	1 / Pack
825043	297	74	Landscape	Do not walk or stand here	1 / Pack
825045	450	150	Landscape	Do not walk or stand here	1 / Pack
825046	600	200	Landscape	Do not walk or stand here	1 / Pack
825039	148	210	Portrait	Do not walk or stand here	1 / Pack
825040	210	297	Portrait	Do not walk or stand here	1 / Pack
825044	297	105	Portrait	Do not walk or stand here	1 / Pack
825041	297	420	Portrait	Do not walk or stand here	1 / Pack
Aluminium					
825050	150	50	Landscape	Do not walk or stand here	1 / Pack
825052	450	150	Landscape	Do not walk or stand here	1 / Pack
825047	148	210	Portrait	Do not walk or stand here	1 / Pack
825048	210	297	Portrait	Do not walk or stand here	1 / Pack
825051	297	105	Portrait	Do not walk or stand here	1 / Pack
825049	297	420	Portrait	Do not walk or stand here	1 / Pack
Laminated Polyester					
825034	150	50	Landscape	Do not walk or stand here	1 / Pack
825035	297	74	Landscape	Do not walk or stand here	1 / Pack
825037	450	150	Landscape	Do not walk or stand here	1 / Pack
825038	600	200	Landscape	Do not walk or stand here	1 / Pack
825031	148	210	Portrait	Do not walk or stand here	1 / Pack
825032	210	297	Portrait	Do not walk or stand here	1 / Pack
825036	297	105	Portrait	Do not walk or stand here	1 / Pack
825033	297	420	Portrait	Do not walk or stand here	1 / Pack



PICTOGRAMS ON ROLLS

Order Ref.	Diameter (mm)	Total Qty/Pack
Laminated Polyester		
824971	25	250 / Roll
824973	50	250 / Roll
824975	100	250 / Roll



PHOTOLUMINESCENT SIGNS

Order Ref.	Diameter (mm)	Class	Total Qty/Pack
Class B Photoluminescent Polyester			
836063	150	Class B	1 / Pack
Class C Photoluminescent Polyester			
836064	150	Class C	1 / Pack
Class B Photoluminescent Polypropylene			
836061	150	Class B	1 / Pack
Class C Photoluminescent Polypropylene			
836062	150	Class C	1 / Pack
Class C Photoluminescent Aluminium			
836060	150	Class C	1 / Pack

i For all material properties and applications, see pages 4-5

BRADY Customise-it See page 196 to order your custom-made signs.



P025 : Do NOT USE THIS INCOMPLETE SCAFFOLD

When being erected, incomplete scaffolding can be dangerous. Indicating that it is incomplete is therefore important to avoid an accident.



SIGNS

Order Ref.	Diameter (mm)	Total Qty/Pack
Laminated Polyester		
825123	50	2 / Pack
825125	100	1 / Pack
825126	200	1 / Pack
825127	315	1 / Pack
Polypropylene		
825129	100	1 / Pack
825130	200	1 / Pack
825131	315	1 / Pack
Aluminium		
825133	100	1 / Pack
825134	200	1 / Pack
825135	315	1 / Pack

FLOOR MARKING

Order Ref.	Diameter (mm)	Total Qty/Pack
Anti-skid Laminated Polyester		
825128	500	1 / Pack

MINI-PICTOGRAMS

Order Ref.	Diameter (mm)	Total Qty/Pack
Laminated Polyester		
825121	25	7 / Pack
Vinyl		
825119	15	54 / Pack



PICTOGRAMS ON ROLLS

Order Ref.	Diameter (mm)	Total Qty/Pack
Laminated Polyester		
825120	25	250 / Roll
825122	50	250 / Roll
825124	100	250 / Roll



PHOTOLUMINESCENT SIGNS

Order Ref.	Diameter (mm)	Class	Total Qty/Pack
Class B Photoluminescent Polyester			
836068	150	Class B	1 / Pack
Class C Photoluminescent Polyester			
836069	150	Class C	1 / Pack
Class B Photoluminescent Polypropylene			
836066	150	Class B	1 / Pack
Class C Photoluminescent Polypropylene			
836067	150	Class C	1 / Pack
Class C Photoluminescent Aluminium			
836065	150	Class C	1 / Pack

SIGNS WITH TEXT



Order Ref.	Width (mm)	Height (mm)	Layout	Legend	Total Qty/Pack
Polypropylene					
825191	150	50	Landscape	Do not use this incomplete scaffold	1 / Pack
825192	297	74	Landscape	Do not use this incomplete scaffold	1 / Pack
825194	450	150	Landscape	Do not use this incomplete scaffold	1 / Pack
825195	600	200	Landscape	Do not use this incomplete scaffold	1 / Pack
825188	148	210	Portrait	Do not use this incomplete scaffold	1 / Pack
825189	210	297	Portrait	Do not use this incomplete scaffold	1 / Pack
825193	297	105	Portrait	Do not use this incomplete scaffold	1 / Pack
825190	297	420	Portrait	Do not use this incomplete scaffold	1 / Pack
Aluminium					
825199	150	50	Landscape	Do not use this incomplete scaffold	1 / Pack
825201	450	150	Landscape	Do not use this incomplete scaffold	1 / Pack
825196	148	210	Portrait	Do not use this incomplete scaffold	1 / Pack
825197	210	297	Portrait	Do not use this incomplete scaffold	1 / Pack
825200	297	105	Portrait	Do not use this incomplete scaffold	1 / Pack
825198	297	420	Portrait	Do not use this incomplete scaffold	1 / Pack
Laminated Polyester					
825183	150	50	Landscape	Do not use this incomplete scaffold	1 / Pack
825184	297	74	Landscape	Do not use this incomplete scaffold	1 / Pack
825186	450	150	Landscape	Do not use this incomplete scaffold	1 / Pack
825187	600	200	Landscape	Do not use this incomplete scaffold	1 / Pack
825180	148	210	Portrait	Do not use this incomplete scaffold	1 / Pack
825181	210	297	Portrait	Do not use this incomplete scaffold	1 / Pack
825185	297	105	Portrait	Do not use this incomplete scaffold	1 / Pack
825182	297	420	Portrait	Do not use this incomplete scaffold	1 / Pack



Communication of the status of an installation at any moment using the range of visual tagging. Contact your Brady distributor for more information.



For all material properties and applications, see pages 4-5

BRADY
Customise-it

See page 196 to order your custom-made signs.

Complies with EN ISO 7010

P026 : Do NOT USE THIS DEVICE IN A BATHTUB, SHOWER OR WATER-FILLED RESERVOIR

Some products, generally electric, must never be used in installations where there is contact with water. Specifying this can avoid an accident.



SIGNS

Order Ref.	Diameter (mm)	Total Qty/Pack
Laminated Polyester		
825272	50	2 / Pack
825274	100	1 / Pack
825275	200	1 / Pack
825276	315	1 / Pack
Polypropylene		
825278	100	1 / Pack
825279	200	1 / Pack
825280	315	1 / Pack
Aluminium		
825282	100	1 / Pack
825283	200	1 / Pack
825284	315	1 / Pack

FLOOR MARKING

Order Ref.	Diameter (mm)	Total Qty/Pack
Anti-skid Laminated Polyester		
825277	500	1 / Pack

MINI-PICTOGRAMS

Order Ref.	Diameter (mm)	Total Qty/Pack
Laminated Polyester		
825270	25	7 / Pack
Vinyl		
825268	15	54 / Pack



PICTOGRAMS ON ROLLS

Order Ref.	Diameter (mm)	Total Qty/Pack
Laminated Polyester		
825269	25	250 / Roll
825271	50	250 / Roll
825273	100	250 / Roll



PHOTOLUMINESCENT SIGNS

Order Ref.	Diameter (mm)	Class	Total Qty/Pack
Class B Photoluminescent Polyester			
836073	150	Class B	1 / Pack
Class C Photoluminescent Polyester			
836074	150	Class C	1 / Pack
Class B Photoluminescent Polypropylene			
836071	150	Class B	1 / Pack
Class C Photoluminescent Polypropylene			
836072	150	Class C	1 / Pack
Class C Photoluminescent Aluminium			
836070	150	Class C	1 / Pack

SIGNS WITH TEXT



Order Ref.	Width (mm)	Height (mm)	Layout	Legend	Total Qty/Pack
Polypropylene					
825340	150	50	Land-scape	Do not use this device in a bathtub, shower or water-filled reservoir	1 / Pack
825341	297	74	Land-scape	Do not use this device in a bathtub, shower or water-filled reservoir	1 / Pack
825343	450	150	Land-scape	Do not use this device in a bathtub, shower or water-filled reservoir	1 / Pack
825344	600	200	Land-scape	Do not use this device in a bathtub, shower or water-filled reservoir	1 / Pack
825337	148	210	Portrait	Do not use this device in a bathtub, shower or water-filled reservoir	1 / Pack
825338	210	297	Portrait	Do not use this device in a bathtub, shower or water-filled reservoir	1 / Pack
825342	297	105	Portrait	Do not use this device in a bathtub, shower or water-filled reservoir	1 / Pack
825339	297	420	Portrait	Do not use this device in a bathtub, shower or water-filled reservoir	1 / Pack
Aluminium					
825348	150	50	Land-scape	Do not use this device in a bathtub, shower or water-filled reservoir	1 / Pack
825350	450	150	Land-scape	Do not use this device in a bathtub, shower or water-filled reservoir	1 / Pack
825345	148	210	Portrait	Do not use this device in a bathtub, shower or water-filled reservoir	1 / Pack
825346	210	297	Portrait	Do not use this device in a bathtub, shower or water-filled reservoir	1 / Pack
825349	297	105	Portrait	Do not use this device in a bathtub, shower or water-filled reservoir	1 / Pack
825347	297	420	Portrait	Do not use this device in a bathtub, shower or water-filled reservoir	1 / Pack
Laminated Polyester					
825332	150	50	Land-scape	Do not use this device in a bathtub, shower or water-filled reservoir	1 / Pack
825333	297	74	Land-scape	Do not use this device in a bathtub, shower or water-filled reservoir	1 / Pack
825335	450	150	Land-scape	Do not use this device in a bathtub, shower or water-filled reservoir	1 / Pack
825336	600	200	Land-scape	Do not use this device in a bathtub, shower or water-filled reservoir	1 / Pack
825329	148	210	Portrait	Do not use this device in a bathtub, shower or water-filled reservoir	1 / Pack
825330	210	297	Portrait	Do not use this device in a bathtub, shower or water-filled reservoir	1 / Pack
825334	297	105	Portrait	Do not use this device in a bathtub, shower or water-filled reservoir	1 / Pack
825331	297	420	Portrait	Do not use this device in a bathtub, shower or water-filled reservoir	1 / Pack

i For all material properties and applications, see pages 4-5

BRADY Customise-it See page 196 to order your custom-made signs.



P027 : Do NOT USE THIS LIFT FOR PEOPLE

Some lifts are restricted to the transport of goods and cannot be used by people.



SIGNS

Order Ref.	Diameter (mm)	Total Qty/Pack
Laminated Polyester		
825421	50	2 / Pack
825423	100	1 / Pack
825424	200	1 / Pack
825425	315	1 / Pack
Polypropylene		
825427	100	1 / Pack
825428	200	1 / Pack
825429	315	1 / Pack
Aluminium		
825431	100	1 / Pack
825432	200	1 / Pack
825433	315	1 / Pack

FLOOR MARKING

Order Ref.	Diameter (mm)	Total Qty/Pack
Anti-skid Laminated Polyester		
825426	500	1 / Pack

MINI-PICTOGRAMS

Order Ref.	Diameter (mm)	Total Qty/Pack
Laminated Polyester		
825419	25	7 / Pack
Vinyl		
825417	15	54 / Pack



PICTOGRAMS ON ROLLS

Order Ref.	Diameter (mm)	Total Qty/Pack
Laminated Polyester		
825418	25	250 / Roll
825420	50	250 / Roll
825422	100	250 / Roll



PHOTOLUMINESCENT SIGNS

Order Ref.	Diameter (mm)	Class	Total Qty/Pack
Class B Photoluminescent Polyester			
836078	150	Class B	1 / Pack
Class C Photoluminescent Polyester			
836079	150	Class C	1 / Pack
Class B Photoluminescent Polypropylene			
836076	150	Class B	1 / Pack
Class C Photoluminescent Polypropylene			
836077	150	Class C	1 / Pack
Class C Photoluminescent Aluminium			
836075	150	Class C	1 / Pack

SIGNS WITH TEXT



Order Ref.	Width (mm)	Height (mm)	Layout	Legend	Total Qty/Pack
Polypropylene					
825489	150	50	Landscape	Do not use this lift for people	1 / Pack
825490	297	74	Landscape	Do not use this lift for people	1 / Pack
825492	450	150	Landscape	Do not use this lift for people	1 / Pack
825493	600	200	Landscape	Do not use this lift for people	1 / Pack
825486	148	210	Portrait	Do not use this lift for people	1 / Pack
825487	210	297	Portrait	Do not use this lift for people	1 / Pack
825491	297	105	Portrait	Do not use this lift for people	1 / Pack
825488	297	420	Portrait	Do not use this lift for people	1 / Pack
Aluminium					
825497	150	50	Landscape	Do not use this lift for people	1 / Pack
825499	450	150	Landscape	Do not use this lift for people	1 / Pack
825494	148	210	Portrait	Do not use this lift for people	1 / Pack
825495	210	297	Portrait	Do not use this lift for people	1 / Pack
825498	297	105	Portrait	Do not use this lift for people	1 / Pack
825496	297	420	Portrait	Do not use this lift for people	1 / Pack
Laminated Polyester					
825481	150	50	Landscape	Do not use this lift for people	1 / Pack
825482	297	74	Landscape	Do not use this lift for people	1 / Pack
825484	450	150	Landscape	Do not use this lift for people	1 / Pack
825485	600	200	Landscape	Do not use this lift for people	1 / Pack
825478	148	210	Portrait	Do not use this lift for people	1 / Pack
825479	210	297	Portrait	Do not use this lift for people	1 / Pack
825483	297	105	Portrait	Do not use this lift for people	1 / Pack
825480	297	420	Portrait	Do not use this lift for people	1 / Pack

i For all material properties and applications, see pages 4-5

BRADY Customise-it See page 196 to order your custom-made signs.

Complies with EN ISO 7010

P028 : Do NOT WEAR GLOVES

To protect the hands, gloves are sometimes compulsory. However, in other circumstances, these same gloves are prohibited.



SIGNS

Order Ref.	Diameter (mm)	Total Qty/Pack
Laminated Polyester		
825570	50	2 / Pack
825572	100	1 / Pack
825573	200	1 / Pack
825574	315	1 / Pack
Polypropylene		
825576	100	1 / Pack
825577	200	1 / Pack
825578	315	1 / Pack
Aluminium		
825580	100	1 / Pack
825581	200	1 / Pack
825582	315	1 / Pack

MINI-PICTOGRAMS

Order Ref.	Diameter (mm)	Total Qty/Pack
Laminated Polyester		
825568	25	7 / Pack
Vinyl		
825566	15	54 / Pack

SIGNS WITH TEXT



Order Ref.	Width (mm)	Height (mm)	Layout	Legend	Total Qty/Pack
Polypropylene					
825638	150	50	Landscape	Do not wear gloves	1 / Pack
825639	297	74	Landscape	Do not wear gloves	1 / Pack
825641	450	150	Landscape	Do not wear gloves	1 / Pack
825642	600	200	Landscape	Do not wear gloves	1 / Pack
825635	148	210	Portrait	Do not wear gloves	1 / Pack
825636	210	297	Portrait	Do not wear gloves	1 / Pack
825640	297	105	Portrait	Do not wear gloves	1 / Pack
825637	297	420	Portrait	Do not wear gloves	1 / Pack
Aluminium					
825646	150	50	Landscape	Do not wear gloves	1 / Pack
825648	450	150	Landscape	Do not wear gloves	1 / Pack
825643	148	210	Portrait	Do not wear gloves	1 / Pack
825644	210	297	Portrait	Do not wear gloves	1 / Pack
825647	297	105	Portrait	Do not wear gloves	1 / Pack
825645	297	420	Portrait	Do not wear gloves	1 / Pack
Laminated Polyester					
825630	150	50	Landscape	Do not wear gloves	1 / Pack
825631	297	74	Landscape	Do not wear gloves	1 / Pack
825633	450	150	Landscape	Do not wear gloves	1 / Pack
825634	600	200	Landscape	Do not wear gloves	1 / Pack
825627	148	210	Portrait	Do not wear gloves	1 / Pack
825628	210	297	Portrait	Do not wear gloves	1 / Pack
825632	297	105	Portrait	Do not wear gloves	1 / Pack
825629	297	420	Portrait	Do not wear gloves	1 / Pack



PICTOGRAMS ON ROLLS

Order Ref.	Diameter (mm)	Total Qty/Pack
Laminated Polyester		
825567	25	250 / Roll
825569	50	250 / Roll
825571	100	250 / Roll



PHOTOLUMINESCENT SIGNS

Order Ref.	Diameter (mm)	Class	Total Qty/Pack
Class B Photoluminescent Polyester			
836083	150	Class B	1 / Pack
Class C Photoluminescent Polyester			
836084	150	Class C	1 / Pack
Class B Photoluminescent Polypropylene			
836081	150	Class B	1 / Pack
Class C Photoluminescent Polypropylene			
836082	150	Class C	1 / Pack
Class C Photoluminescent Aluminium			
836080	150	Class C	1 / Pack

i For all material properties and applications, see pages 4-5

BRADY Customise-it See page 196 to order your custom-made signs.



P029 : No PHOTOGRAPHY

In order to protect work or secrets, or simply to avoid distractions, photography may be prohibited.



SIGNS

Order Ref.	Diameter (mm)	Total Qty/Pack
Laminated Polyester		
825719	50	2 / Pack
825721	100	1 / Pack
825722	200	1 / Pack
825723	315	1 / Pack
Polypropylene		
825725	100	1 / Pack
825726	200	1 / Pack
825727	315	1 / Pack
Aluminium		
825729	100	1 / Pack
825730	200	1 / Pack
825731	315	1 / Pack

FLOOR MARKING

Order Ref.	Diameter (mm)	Total Qty/Pack
Anti-skid Laminated Polyester		
825724	500	1 / Pack

MINI-PICTOGRAMS

Order Ref.	Diameter (mm)	Total Qty/Pack
Laminated Polyester		
825717	25	7 / Pack
Vinyl		
825715	15	54 / Pack

SIGNS WITH TEXT

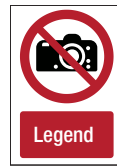

Order Ref.	Width (mm)	Height (mm)	Layout	Legend	Total Qty/Pack
Polypropylene					
825787	150	50	Landscape	No photography	1 / Pack
825788	297	74	Landscape	No photography	1 / Pack
825790	450	150	Landscape	No photography	1 / Pack
825791	600	200	Landscape	No photography	1 / Pack
825784	148	210	Portrait	No photography	1 / Pack
825785	210	297	Portrait	No photography	1 / Pack
825789	297	105	Portrait	No photography	1 / Pack
825786	297	420	Portrait	No photography	1 / Pack
Aluminium					
825795	150	50	Landscape	No photography	1 / Pack
825797	450	150	Landscape	No photography	1 / Pack
825792	148	210	Portrait	No photography	1 / Pack
825793	210	297	Portrait	No photography	1 / Pack
825796	297	105	Portrait	No photography	1 / Pack
825794	297	420	Portrait	No photography	1 / Pack
Laminated Polyester					
825779	150	50	Landscape	No photography	1 / Pack
825780	297	74	Landscape	No photography	1 / Pack
825782	450	150	Landscape	No photography	1 / Pack
825783	600	200	Landscape	No photography	1 / Pack
825776	148	210	Portrait	No photography	1 / Pack
825777	210	297	Portrait	No photography	1 / Pack
825781	297	105	Portrait	No photography	1 / Pack
825778	297	420	Portrait	No photography	1 / Pack



PICTOGRAMS ON ROLLS

Order Ref.	Diameter (mm)	Total Qty/Pack
Laminated Polyester		
825716	25	250 / Roll
825718	50	250 / Roll
825720	100	250 / Roll



PHOTOLUMINESCENT SIGNS

Order Ref.	Diameter (mm)	Class	Total Qty/Pack
Class B Photoluminescent Polyester			
836088	150	Class B	1 / Pack
Class C Photoluminescent Polyester			
836089	150	Class C	1 / Pack
Class B Photoluminescent Polypropylene			
836086	150	Class B	1 / Pack
Class C Photoluminescent Polypropylene			
836087	150	Class C	1 / Pack
Class C Photoluminescent Aluminium			
836085	150	Class C	1 / Pack

i For all material properties and applications, see pages 4-5

BRADY Customise-it See page 196 to order your custom-made signs.

Complies with EN ISO 7010

P030 : Do NOT TIE KNOTS IN ROPE

A knot in a rope could damage an installation or cause an incident. It is therefore sometimes preferable to provide a reminder of this.



SIGNS

Order Ref.	Diameter (mm)	Total Qty/Pack
Laminated Polyester		
825868	50	2 / Pack
825870	100	1 / Pack
825871	200	1 / Pack
825872	315	1 / Pack
Polypropylene		
825874	100	1 / Pack
825875	200	1 / Pack
825876	315	1 / Pack
Aluminium		
825878	100	1 / Pack
825879	200	1 / Pack
825880	315	1 / Pack

MINI-PICTOGRAMS

Order Ref.	Diameter (mm)	Total Qty/Pack
Laminated Polyester		
825866	25	7 / Pack
Vinyl		
825864	15	54 / Pack



PICTOGRAMS ON ROLLS

Order Ref.	Diameter (mm)	Total Qty/Pack
Laminated Polyester		
825865	25	250 / Roll
825867	50	250 / Roll
825869	100	250 / Roll



PHOTOLUMINESCENT SIGNS

Order Ref.	Diameter (mm)	Class	Total Qty/Pack
Class B Photoluminescent Polyester			
836093	150	Class B	1 / Pack
Class C Photoluminescent Polyester			
836094	150	Class C	1 / Pack
Class B Photoluminescent Polypropylene			
836091	150	Class B	1 / Pack
Class C Photoluminescent Polypropylene			
836092	150	Class C	1 / Pack
Class C Photoluminescent Aluminium			
836090	150	Class C	1 / Pack

SIGNS WITH TEXT



Order Ref.	Width (mm)	Height (mm)	Layout	Legend	Total Qty/Pack
Polypropylene					
825936	150	50	Landscape	Do not tie knots in rope	1 / Pack
825937	297	74	Landscape	Do not tie knots in rope	1 / Pack
825939	450	150	Landscape	Do not tie knots in rope	1 / Pack
825940	600	200	Landscape	Do not tie knots in rope	1 / Pack
825933	148	210	Portrait	Do not tie knots in rope	1 / Pack
825934	210	297	Portrait	Do not tie knots in rope	1 / Pack
825938	297	105	Portrait	Do not tie knots in rope	1 / Pack
825935	297	420	Portrait	Do not tie knots in rope	1 / Pack
Aluminium					
825944	150	50	Landscape	Do not tie knots in rope	1 / Pack
825946	450	150	Landscape	Do not tie knots in rope	1 / Pack
825941	148	210	Portrait	Do not tie knots in rope	1 / Pack
825942	210	297	Portrait	Do not tie knots in rope	1 / Pack
825945	297	105	Portrait	Do not tie knots in rope	1 / Pack
825943	297	420	Portrait	Do not tie knots in rope	1 / Pack
Laminated Polyester					
825928	150	50	Landscape	Do not tie knots in rope	1 / Pack
825929	297	74	Landscape	Do not tie knots in rope	1 / Pack
825931	450	150	Landscape	Do not tie knots in rope	1 / Pack
825932	600	200	Landscape	Do not tie knots in rope	1 / Pack
825925	148	210	Portrait	Do not tie knots in rope	1 / Pack
825926	210	297	Portrait	Do not tie knots in rope	1 / Pack
825930	297	105	Portrait	Do not tie knots in rope	1 / Pack
825927	297	420	Portrait	Do not tie knots in rope	1 / Pack

i For all material properties and applications, see pages 4-5

BRADY Customise-it See page 196 to order your custom-made signs.



P031 : Do NOT ALTER THE STATE OF THE SWITCH

Altering the state of a switch always has consequences. However, in certain circumstances, it is essential to give a reminder that this position must not be changed.



SIGNS

Order Ref.	Diameter (mm)	Total Qty/Pack
Laminated Polyester		
826017	50	2 / Pack
826019	100	1 / Pack
826020	200	1 / Pack
826021	315	1 / Pack
Polypropylene		
826023	100	1 / Pack
826024	200	1 / Pack
826025	315	1 / Pack
Aluminium		
826027	100	1 / Pack
826028	200	1 / Pack
826029	315	1 / Pack

MINI-PICTOGRAMS

Order Ref.	Diameter (mm)	Total Qty/Pack
Laminated Polyester		
826015	25	7 / Pack
Vinyl		
826013	15	54 / Pack



PICTOGRAMS ON ROLLS

Order Ref.	Diameter (mm)	Total Qty/Pack
Laminated Polyester		
826014	25	250 / Roll
826016	50	250 / Roll
826018	100	250 / Roll



PHOTOLUMINESCENT SIGNS

Order Ref.	Diameter (mm)	Class	Total Qty/Pack
Class B Photoluminescent Polyester			
836098	150	Class B	1 / Pack
Class C Photoluminescent Polyester			
836099	150	Class C	1 / Pack
Class B Photoluminescent Polypropylene			
836096	150	Class B	1 / Pack
Class C Photoluminescent Polypropylene			
836097	150	Class C	1 / Pack
Class C Photoluminescent Aluminium			
836095	150	Class C	1 / Pack

SIGNS WITH TEXT



Order Ref.	Width (mm)	Height (mm)	Layout	Legend	Total Qty/Pack
Polypropylene					
826085	150	50	Landscape	Do not alter the switch	1 / Pack
826086	297	74	Landscape	Do not alter the switch	1 / Pack
826088	450	150	Landscape	Do not alter the switch	1 / Pack
826089	600	200	Landscape	Do not alter the switch	1 / Pack
826082	148	210	Portrait	Do not alter the switch	1 / Pack
826083	210	297	Portrait	Do not alter the switch	1 / Pack
826087	297	105	Portrait	Do not alter the switch	1 / Pack
826084	297	420	Portrait	Do not alter the switch	1 / Pack
Aluminium					
826093	150	50	Landscape	Do not alter the switch	1 / Pack
826095	450	150	Landscape	Do not alter the switch	1 / Pack
826090	148	210	Portrait	Do not alter the switch	1 / Pack
826091	210	297	Portrait	Do not alter the switch	1 / Pack
826094	297	105	Portrait	Do not alter the switch	1 / Pack
826092	297	420	Portrait	Do not alter the switch	1 / Pack
Laminated Polyester					
826077	150	50	Landscape	Do not alter the switch	1 / Pack
826078	297	74	Landscape	Do not alter the switch	1 / Pack
826080	450	150	Landscape	Do not alter the switch	1 / Pack
826081	600	200	Landscape	Do not alter the switch	1 / Pack
826074	148	210	Portrait	Do not alter the switch	1 / Pack
826075	210	297	Portrait	Do not alter the switch	1 / Pack
826079	297	105	Portrait	Do not alter the switch	1 / Pack
826076	297	420	Portrait	Do not alter the switch	1 / Pack

i For all material properties and applications, see pages 4-5

BRADY Customise-it See page 196 to order your custom-made signs.

Complies with EN ISO 7010

P032 : Do NOT USE FOR FACE GRINDING

Flat surfaces can be ground using the different faces of the grinder. However, some tools cannot be used for flat grinding, this must therefore be pointed out.



SIGNS

Order Ref.	Diameter (mm)	Total Qty/Pack
Laminated Polyester		
826166	50	2 / Pack
826168	100	1 / Pack
826169	200	1 / Pack
826170	315	1 / Pack
Polypropylene		
826172	100	1 / Pack
826173	200	1 / Pack
826174	315	1 / Pack
Aluminium		
826176	100	1 / Pack
826177	200	1 / Pack
826178	315	1 / Pack

SIGNS WITH TEXT



Order Ref.	Width (mm)	Height (mm)	Layout	Legend	Total Qty/Pack
Polypropylene					
826234	150	50	Landscape	Do not use for face grinding	1 / Pack
826235	297	74	Landscape	Do not use for face grinding	1 / Pack
826237	450	150	Landscape	Do not use for face grinding	1 / Pack
826238	600	200	Landscape	Do not use for face grinding	1 / Pack
826231	148	210	Portrait	Do not use for face grinding	1 / Pack
826232	210	297	Portrait	Do not use for face grinding	1 / Pack
826236	297	105	Portrait	Do not use for face grinding	1 / Pack
826233	297	420	Portrait	Do not use for face grinding	1 / Pack
Aluminium					
826242	150	50	Landscape	Do not use for face grinding	1 / Pack
826244	450	150	Landscape	Do not use for face grinding	1 / Pack
826239	148	210	Portrait	Do not use for face grinding	1 / Pack
826240	210	297	Portrait	Do not use for face grinding	1 / Pack
826243	297	105	Portrait	Do not use for face grinding	1 / Pack
826241	297	420	Portrait	Do not use for face grinding	1 / Pack
Laminated Polyester					
826226	150	50	Landscape	Do not use for face grinding	1 / Pack
826227	297	74	Landscape	Do not use for face grinding	1 / Pack
826229	450	150	Landscape	Do not use for face grinding	1 / Pack
826230	600	200	Landscape	Do not use for face grinding	1 / Pack
826223	148	210	Portrait	Do not use for face grinding	1 / Pack
826224	210	297	Portrait	Do not use for face grinding	1 / Pack
826228	297	105	Portrait	Do not use for face grinding	1 / Pack
826225	297	420	Portrait	Do not use for face grinding	1 / Pack



PICTOGRAMS ON ROLLS

Order Ref.	Diameter (mm)	Total Qty/Pack
Laminated Polyester		
826163	25	250 / Roll
826165	50	250 / Roll
826167	100	250 / Roll

Complies with EN ISO 7010

P033 : Do NOT USE FOR WET GRINDING

The surfaces can be ground using the different faces of the grinder. However, some tools cannot be used for wet grinding, this must therefore be pointed out.



SIGNS

Order Ref.	Diameter (mm)	Total Qty/Pack
Laminated Polyester		
826315	50	2 / Pack
826317	100	1 / Pack
826318	200	1 / Pack
826319	315	1 / Pack
Polypropylene		
826321	100	1 / Pack
826322	200	1 / Pack
826323	315	1 / Pack
Aluminium		
826325	100	1 / Pack
826326	200	1 / Pack
826327	315	1 / Pack

SIGNS WITH TEXT



Order Ref.	Width (mm)	Height (mm)	Layout	Legend	Total Qty/Pack
Polypropylene					
826383	150	50	Landscape	Do not use for wet grinding	1 / Pack
826384	297	74	Landscape	Do not use for wet grinding	1 / Pack
826386	450	150	Landscape	Do not use for wet grinding	1 / Pack
826387	600	200	Landscape	Do not use for wet grinding	1 / Pack
826380	148	210	Portrait	Do not use for wet grinding	1 / Pack
826381	210	297	Portrait	Do not use for wet grinding	1 / Pack
826385	297	105	Portrait	Do not use for wet grinding	1 / Pack
826382	297	420	Portrait	Do not use for wet grinding	1 / Pack
Aluminium					
826391	150	50	Landscape	Do not use for wet grinding	1 / Pack
826393	450	150	Landscape	Do not use for wet grinding	1 / Pack
826388	148	210	Portrait	Do not use for wet grinding	1 / Pack
826389	210	297	Portrait	Do not use for wet grinding	1 / Pack
826392	297	105	Portrait	Do not use for wet grinding	1 / Pack
826390	297	420	Portrait	Do not use for wet grinding	1 / Pack
Laminated Polyester					
826375	150	50	Landscape	Do not use for wet grinding	1 / Pack
826376	297	74	Landscape	Do not use for wet grinding	1 / Pack
826378	450	150	Landscape	Do not use for wet grinding	1 / Pack
826379	600	200	Landscape	Do not use for wet grinding	1 / Pack
826372	148	210	Portrait	Do not use for wet grinding	1 / Pack
826373	210	297	Portrait	Do not use for wet grinding	1 / Pack
826377	297	105	Portrait	Do not use for wet grinding	1 / Pack
826374	297	420	Portrait	Do not use for wet grinding	1 / Pack



PICTOGRAMS ON ROLLS

Order Ref.	Diameter (mm)	Total Qty/Pack
Laminated Polyester		
826312	25	250 / Roll
826314	50	250 / Roll
826316	100	250 / Roll



P034 : Do NOT USE WITH HAND-HELD GRINDING MACHINE

Certain products cannot be ground with a hand-held grinding machine.



SIGNS

Order Ref.	Diameter (mm)	Total Qty/Pack
Laminated Polyester		
826464	50	2 / Pack
826466	100	1 / Pack
826467	200	1 / Pack
826468	315	1 / Pack
Polypropylene		
826470	100	1 / Pack
826471	200	1 / Pack
826472	315	1 / Pack
Aluminium		
826474	100	1 / Pack
826475	200	1 / Pack
826476	315	1 / Pack

MINI-PICTOGRAMS

Order Ref.	Diameter (mm)	Total Qty/Pack
Laminated Polyester		
826462	25	7 / Pack
Vinyl		
826460	15	54 / Pack

SIGNS WITH TEXT



Order Ref.	Width (mm)	Height (mm)	Layout	Legend	Total Qty/Pack
Polypropylene					
826532	150	50	Landscape	Do not use with hand-held grinding machine	1 / Pack
826533	297	74	Landscape	Do not use with hand-held grinding machine	1 / Pack
826535	450	150	Landscape	Do not use with hand-held grinding machine	1 / Pack
826536	600	200	Landscape	Do not use with hand-held grinding machine	1 / Pack
826529	148	210	Portrait	Do not use with hand-held grinding machine	1 / Pack
826530	210	297	Portrait	Do not use with hand-held grinding machine	1 / Pack
826534	297	105	Portrait	Do not use with hand-held grinding machine	1 / Pack
826531	297	420	Portrait	Do not use with hand-held grinding machine	1 / Pack
Aluminium					
826540	150	50	Landscape	Do not use with hand-held grinding machine	1 / Pack
826542	450	150	Landscape	Do not use with hand-held grinding machine	1 / Pack
826537	148	210	Portrait	Do not use with hand-held grinding machine	1 / Pack
826538	210	297	Portrait	Do not use with hand-held grinding machine	1 / Pack
826541	297	105	Portrait	Do not use with hand-held grinding machine	1 / Pack
826539	297	420	Portrait	Do not use with hand-held grinding machine	1 / Pack
Laminated Polyester					
826524	150	50	Landscape	Do not use with hand-held grinding machine	1 / Pack
826525	297	74	Landscape	Do not use with hand-held grinding machine	1 / Pack
826527	450	150	Landscape	Do not use with hand-held grinding machine	1 / Pack
826528	600	200	Landscape	Do not use with hand-held grinding machine	1 / Pack
826521	148	210	Portrait	Do not use with hand-held grinding machine	1 / Pack
826522	210	297	Portrait	Do not use with hand-held grinding machine	1 / Pack
826526	297	105	Portrait	Do not use with hand-held grinding machine	1 / Pack
826523	297	420	Portrait	Do not use with hand-held grinding machine	1 / Pack



PICTOGRAMS ON ROLLS

Order Ref.	Diameter (mm)	Total Qty/Pack
Laminated Polyester		
826461	25	250 / Roll
826463	50	250 / Roll
826465	100	250 / Roll

i LOCKOUT/TAGOUT SYSTEMS

Lockout/Tagout is a procedure created to protect workers involved in the maintenance and servicing of tools against the accidental starting of the various energy sources. This is obtained by mechanically isolating, identifying and locking these energy sources. Contact your Brady distributor to find out more about our full range of lockout/tagout systems.

Lockout / Tagout

Solutions for Hazardous Energy Control
Create, visualise and manage your Isolation Programme

Complies with EN ISO 7010

P035 : Do NOT WEAR METAL-STUDED FOOTWEAR

Metal-studded footwear can represent a risk if it is worn in an unsuitable environment. It is therefore vital to point out that it is prohibited.



SIGNS

Order Ref.	Diameter (mm)	Total Qty/Pack
Laminated Polyester		
831336	50	2 / Pack
831338	100	1 / Pack
831339	200	1 / Pack
831340	315	1 / Pack
Polypropylene		
831342	100	1 / Pack
831343	200	1 / Pack
831344	315	1 / Pack
Aluminium		
831346	100	1 / Pack
831347	200	1 / Pack
831348	315	1 / Pack

FLOOR MARKING

Order Ref.	Diameter (mm)	Total Qty/Pack
Anti-skid Laminated Polyester		
831341	500	1 / Pack

MINI-PICTOGRAMS

Order Ref.	Diameter (mm)	Total Qty/Pack
Laminated Polyester		
831334	25	7 / Pack
831335	50	250 / Roll



PICTOGRAMS ON ROLLS

Order Ref.	Diameter (mm)	Total Qty/Pack
Laminated Polyester		
831333	25	250 / Roll
831335	50	250 / Roll
831337	100	250 / Roll



PHOTOLUMINESCENT SIGNS

Order Ref.	Diameter (mm)	Class	Total Qty/Pack
Class B Photoluminescent Polyester			
836118	150	Class B	1 / Pack
Class C Photoluminescent Polyester			
836119	150	Class C	1 / Pack
Class B Photoluminescent Polypropylene			
836116	150	Class B	1 / Pack
Class C Photoluminescent Polypropylene			
836117	150	Class C	1 / Pack
Class C Photoluminescent Aluminium			
836115	150	Class C	1 / Pack

Complies with EN ISO 7010

P036 : No CHILDREN ALLOWED

For their safety, children are not allowed in certain places.



SIGNS

Order Ref.	Diameter (mm)	Total Qty/Pack
Laminated Polyester		
831353	50	2 / Pack
831355	100	1 / Pack
831356	200	1 / Pack
831357	315	1 / Pack
Polypropylene		
831359	100	1 / Pack
831360	200	1 / Pack
831361	315	1 / Pack
Aluminium		
831363	100	1 / Pack
831364	200	1 / Pack
831365	315	1 / Pack

FLOOR MARKING

Order Ref.	Diameter (mm)	Total Qty/Pack
Anti-skid Laminated Polyester		
831358	500	1 / Pack

MINI-PICTOGRAMS

Order Ref.	Diameter (mm)	Total Qty/Pack
Laminated Polyester		
831351	25	7 / Pack
Vinyl		
831349	15	54 / Pack



PICTOGRAMS ON ROLLS

Order Ref.	Diameter (mm)	Total Qty/Pack
Laminated Polyester		
831350	25	250 / Roll
831352	50	250 / Roll
831354	100	250 / Roll



PHOTOLUMINESCENT SIGNS

Order Ref.	Diameter (mm)	Class	Total Qty/Pack
Class B Photoluminescent Polyester			
836123	150	Class B	1 / Pack
Class C Photoluminescent Polyester			
836124	150	Class C	1 / Pack
Class B Photoluminescent Polypropylene			
836121	150	Class B	1 / Pack
Class C Photoluminescent Polypropylene			
836122	150	Class C	1 / Pack
Class C Photoluminescent Aluminium			
836120	150	Class C	1 / Pack

i For all material properties and applications, see pages 4-5

BRADY Customise-it See page 196 to order your custom-made signs.



P037 : Do NOT LEAVE THE TOW-TRACK

In mountain resorts, some rules must be respected for the safety of everyone. One of them bans getting off the ski lift.



SIGNS

Order Ref.	Diameter (mm)	Total Qty/Pack
Laminated Polyester		
135774	100	1 / Pack
135775	150	1 / Pack
135776	200	1 / Pack
Polypropylene		
135768	100	1 / Pack
135769	150	1 / Pack
135770	200	1 / Pack
Aluminium		
135771	100	1 / Pack
135772	150	1 / Pack
135773	200	1 / Pack



PHOTOLUMINESCENT SIGNS

Order Ref.	Diameter (mm)	Class	Total Qty/Pack
Class B Photoluminescent Polyester			
135783	100	Class B	1 / Pack
135784	150	Class B	1 / Pack
135785	200	Class B	1 / Pack
Class C Photoluminescent Polyester			
135792	100	Class C	1 / Pack
135793	150	Class C	1 / Pack
135794	200	Class C	1 / Pack
Class B Photoluminescent Polypropylene			
135777	100	Class B	1 / Pack
135778	150	Class B	1 / Pack
135779	200	Class B	1 / Pack
Class C Photoluminescent Polypropylene			
135786	100	Class C	1 / Pack
135787	150	Class C	1 / Pack
135788	200	Class C	1 / Pack
Class C Photoluminescent Aluminium			
135789	100	Class C	1 / Pack
135790	150	Class C	1 / Pack
135791	200	Class C	1 / Pack



P038 : Do NOT SWING THE CHAIR

In mountain resorts, some rules must be respected for the safety of everyone. One of them prohibits swinging the chairs.



SIGNS

Order Ref.	Diameter (mm)	Total Qty/Pack
Laminated Polyester		
135802	100	1 / Pack
135803	150	1 / Pack
135804	200	1 / Pack
Polypropylene		
135795	100	1 / Pack
135796	150	1 / Pack
135797	200	1 / Pack
Aluminium		
135799	100	1 / Pack
135800	150	1 / Pack
135801	200	1 / Pack



PHOTOLUMINESCENT SIGNS

Order Ref.	Diameter (mm)	Class	Total Qty/Pack
Class B Photoluminescent Polyester			
135811	100	Class B	1 / Pack
135812	150	Class B	1 / Pack
135813	200	Class B	1 / Pack
Class C Photoluminescent Polyester			
135820	100	Class C	1 / Pack
135821	150	Class C	1 / Pack
135822	200	Class C	1 / Pack
Class B Photoluminescent Polypropylene			
135805	100	Class B	1 / Pack
135806	150	Class B	1 / Pack
135807	200	Class B	1 / Pack
Class C Photoluminescent Polypropylene			
135814	100	Class C	1 / Pack
135815	150	Class C	1 / Pack
135816	200	Class C	1 / Pack
Class C Photoluminescent Aluminium			
135817	100	Class C	1 / Pack
135818	150	Class C	1 / Pack
135819	200	Class C	1 / Pack

i For all material properties and applications, see pages 4-5

BRADY Customise-it See page 196 to order your custom-made signs.

Complies with EN ISO 7010

P040 : Do NOT SET OFF FIREWORKS

Prohibits people from setting of fireworks in areas where this would be dangerous or otherwise highly unwanted.



SIGNS

Order Ref.	Diameter (mm)	Total Qty/Pack
Laminated Polyester		
196777	50	2 / Pack
196778	100	1 / Pack
196779	200	1 / Pack
196780	315	1 / Pack
Polypropylene		
196781	100	1 / Pack
196782	200	1 / Pack
196783	315	1 / Pack
Aluminium		
196784	100	1 / Pack
196785	200	1 / Pack
196786	315	1 / Pack

FLOOR MARKING

Order Ref.	Diameter (mm)	Total Qty/Pack
Anti-skid Laminated Polyester		
196820	500	1 / Pack

MINI-PICTOGRAMS

Order Ref.	Diameter (mm)	Total Qty/Pack
Laminated Polyester		
196814	20	18 / Pack
196815	25	7 / Pack
196816	30	15 / Pack
Vinyl		
196813	15	54 / Pack

PICTOGRAMS ON ROLLS



Order Ref.	Diameter (mm)	Total Qty/Pack
Laminated Polyester		
196817	25	250 / Pack
196818	50	250 / Pack
196819	100	250 / Pack

SIGNS WITH TEXT



Order Ref.	Width (mm)	Height (mm)	Layout	Legend	Total Qty/Pack
Polypropylene					
196794	150	50	Landscape	Do not set off fireworks	1 / Pack
196795	297	105	Landscape	Do not set off fireworks	1 / Pack
196796	450	150	Landscape	Do not set off fireworks	1 / Pack
196797	600	200	Landscape	Do not set off fireworks	1 / Pack
196798	148	210	Portrait	Do not set off fireworks	1 / Pack
196799	210	297	Portrait	Do not set off fireworks	1 / Pack
196800	297	420	Portrait	Do not set off fireworks	1 / Pack
Aluminium					
196803	150	50	Landscape	Do not set off fireworks	1 / Pack
196804	297	105	Landscape	Do not set off fireworks	1 / Pack
196805	450	150	Landscape	Do not set off fireworks	1 / Pack
196806	148	210	Portrait	Do not set off fireworks	1 / Pack
196807	210	297	Portrait	Do not set off fireworks	1 / Pack
196808	297	420	Portrait	Do not set off fireworks	1 / Pack
Laminated Polyester					
196787	150	50	Landscape	Do not set off fireworks	1 / Pack
196788	297	105	Landscape	Do not set off fireworks	1 / Pack
196789	450	150	Landscape	Do not set off fireworks	1 / Pack
196790	600	200	Landscape	Do not set off fireworks	1 / Pack
196791	148	210	Portrait	Do not set off fireworks	1 / Pack
196792	210	297	Portrait	Do not set off fireworks	1 / Pack
196793	297	420	Portrait	Do not set off fireworks	1 / Pack

PHOTOLUMINESCENT SIGNS



Order Ref.	Diameter (mm)	Total Qty/Pack
Class B Photoluminescent Polyester		
196809	150	1 / Pack
Class C Photoluminescent Polyester		
196810	150	1 / Pack
Class B Photoluminescent Polypropylene		
196811	150	1 / Pack
Class C Photoluminescent Polypropylene		
196812	150	1 / Pack
Class C Photoluminescent Aluminium		
197585	150	1 / Pack

i For all material properties and applications, see pages 4-5

BRADY Customise-it See page 196 to order your custom-made signs.



P041 : No LEANING AGAINST

Prohibits people from leaning against large or stacked objects that could easily fall over.



SIGNS

Order Ref.	Diameter (mm)	Total Qty/ Pack
Laminated Polyester		
196881	50	2 / Pack
196882	100	1 / Pack
196883	200	1 / Pack
196884	315	1 / Pack
Polypropylene		
196885	100	1 / Pack
196886	200	1 / Pack
196887	315	1 / Pack
Aluminium		
196888	100	1 / Pack
196889	200	1 / Pack
196890	315	1 / Pack

FLOOR MARKING

Order Ref.	Diameter (mm)	Total Qty/ Pack
Anti-skid Laminated Polyester		
196922	500	1 / Pack

MINI-PICTOGRAMS

Order Ref.	Diameter (mm)	Total Qty/ Pack
Laminated Polyester		
196916	20	18 / Pack
196917	25	7 / Pack
196918	30	15 / Pack
Vinyl		
196915	15	54 / Pack



PICTOGRAMS ON ROLLS

Order Ref.	Diameter (mm)	Total Qty/ Pack
Laminated Polyester		
196919	25	250 / Pack
196920	50	250 / Pack
196921	100	250 / Pack

SIGNS WITH TEXT



Order Ref.	Width (mm)	Height (mm)	Layout	Legend	Total Qty/ Pack
Polypropylene					
196898	150	50	Landscape	Do not lean against	1 / Pack
196899	297	105	Landscape	Do not lean against	1 / Pack
196900	450	150	Landscape	Do not lean against	1 / Pack
196901	600	200	Landscape	Do not lean against	1 / Pack
196902	148	210	Portrait	Do not lean against	1 / Pack
196903	210	297	Portrait	Do not lean against	1 / Pack
196904	297	420	Portrait	Do not lean against	1 / Pack
Aluminium					
196905	150	50	Landscape	Do not lean against	1 / Pack
196906	297	105	Landscape	Do not lean against	1 / Pack
196907	450	150	Landscape	Do not lean against	1 / Pack
196908	148	210	Portrait	Do not lean against	1 / Pack
196909	210	297	Portrait	Do not lean against	1 / Pack
196910	297	420	Portrait	Do not lean against	1 / Pack
Laminated Polyester					
196891	150	50	Landscape	Do not lean against	1 / Pack
196892	297	105	Landscape	Do not lean against	1 / Pack
196893	450	150	Landscape	Do not lean against	1 / Pack
196894	600	200	Landscape	Do not lean against	1 / Pack
196895	148	210	Portrait	Do not lean against	1 / Pack
196896	210	297	Portrait	Do not lean against	1 / Pack
196897	297	420	Portrait	Do not lean against	1 / Pack

PHOTOLUMINESCENT SIGNS



Order Ref.	Diameter (mm)	Class	Total Qty/ Pack
Class B Photoluminescent Polyester			
196911	150	Class B	1 / Pack
Class C Photoluminescent Polyester			
196912	150	Class C	1 / Pack
Class B Photoluminescent Polypropylene			
196913	150	Class B	1 / Pack
Class C Photoluminescent Polypropylene			
196914	150	Class C	1 / Pack
Class C Photoluminescent Aluminium			
197586	150	Class C	1 / Pack

i For all material properties and applications, see pages 4-5

BRADY Customise-it See page 196 to order your custom-made signs.

Complies with EN ISO 7010

P042 : NOT FOR PREGNANT WOMEN

To prohibit pregnant women undertaking hazardous actions or activities



SIGNS

Order Ref.	Diameter (mm)	Total Qty/ Pack
Laminated Polyester		
196983	50	2 / Pack
196984	100	1 / Pack
196985	200	1 / Pack
196986	315	1 / Pack
Polypropylene		
196987	100	1 / Pack
196988	200	1 / Pack
196989	315	1 / Pack
Aluminium		
196990	100	1 / Pack
196991	200	1 / Pack
196992	315	1 / Pack

FLOOR MARKING

Order Ref.	Diameter (mm)	Total Qty/ Pack
Anti-skid Laminated Polyester		
197028	500	1 / Pack

MINI-PICTOGRAMS

Order Ref.	Diameter (mm)	Total Qty/ Pack
Laminated Polyester		
197021	20	18 / Pack
197022	25	7 / Pack
197023	30	15 / Pack
Vinyl		
197019	15	54 / Pack



PICTOGRAMS ON ROLLS

Order Ref.	Diameter (mm)	Total Qty/ Pack
Laminated Polyester		
197025	25	250 / Pack
197026	50	250 / Pack
197027	100	250 / Pack

SIGNS WITH TEXT



Order Ref.	Width (mm)	Height (mm)	Layout	Legend	Total Qty/ Pack
Polypropylene					
197000	150	50	Landscape	No pregnant women allowed	1 / Pack
197001	297	105	Landscape	No pregnant women allowed	1 / Pack
197002	450	150	Landscape	No pregnant women allowed	1 / Pack
197003	600	200	Landscape	No pregnant women allowed	1 / Pack
197004	148	210	Portrait	No pregnant women allowed	1 / Pack
197005	210	297	Portrait	No pregnant women allowed	1 / Pack
197006	297	420	Portrait	No pregnant women allowed	1 / Pack
Aluminium					
197007	150	50	Landscape	No pregnant women allowed	1 / Pack
197008	297	105	Landscape	No pregnant women allowed	1 / Pack
197009	450	150	Landscape	No pregnant women allowed	1 / Pack
197010	148	210	Portrait	No pregnant women allowed	1 / Pack
197011	210	297	Portrait	No pregnant women allowed	1 / Pack
197013	297	420	Portrait	No pregnant women allowed	1 / Pack
Laminated Polyester					
196993	150	50	Landscape	No pregnant women allowed	1 / Pack
196994	297	105	Landscape	No pregnant women allowed	1 / Pack
196995	450	150	Landscape	No pregnant women allowed	1 / Pack
196996	600	200	Landscape	No pregnant women allowed	1 / Pack
196997	148	210	Portrait	No pregnant women allowed	1 / Pack
196998	210	297	Portrait	No pregnant women allowed	1 / Pack
196999	297	420	Portrait	No pregnant women allowed	1 / Pack

PHOTOLUMINESCENT SIGNS



Order Ref.	Diameter (mm)	Class	Total Qty/ Pack
Class B Photoluminescent Polyester			
197014	150	Class B	1 / Pack
Class C Photoluminescent Polyester			
197015	150	Class C	1 / Pack
Class B Photoluminescent Polypropylene			
197017	150	Class B	1 / Pack
Class C Photoluminescent Polypropylene			
197018	150	Class C	1 / Pack
Class C Photoluminescent Aluminium			
197587	150	Class C	1 / Pack

i For all material properties and applications, see pages 4-5

BRADY Customise-it See page 196 to order your custom-made signs.



P043 : NOT FOR PEOPLE IN THE STATE OF INTOXICATION

Clearly indicates that a facility or area is out of bounds for anyone in the state of intoxication.



SIGNS

Order Ref.	Diameter (mm)	Total Qty/ Pack
Laminated Polyester		
198157	50	2 / Pack
198158	100	1 / Pack
198159	200	1 / Pack
198160	315	1 / Pack
Polypropylene		
198161	100	1 / Pack
198162	200	1 / Pack
198163	315	1 / Pack
Aluminium		
198164	100	1 / Pack
198165	200	1 / Pack
198166	315	1 / Pack

FLOOR MARKING

Order Ref.	Diameter (mm)	Total Qty/ Pack
Anti-skid Laminated Polyester		
198199	500	1 / Pack

MINI-PICTOGRAMS

Order Ref.	Diameter (mm)	Total Qty/ Pack
Laminated Polyester		
198193	20	18 / Pack
198194	25	7 / Pack
198195	30	15 / Pack
Vinyl		
198192	15	54 / Pack



PICTOGRAMS ON ROLLS

Order Ref.	Diameter (mm)	Total Qty/ Pack
Laminated Polyester		
198196	25	250 / Pack
198197	50	250 / Pack
198198	100	250 / Pack

SIGNS WITH TEXT



Order Ref.	Width (mm)	Height (mm)	Layout	Legend	Total Qty/ Pack
Laminated Polyester					
198167	150	50	Landscape	Do not use while intoxicated	1 / Pack
198168	297	105	Landscape	Do not use while intoxicated	1 / Pack
198169	450	150	Landscape	Do not use while intoxicated	1 / Pack
198170	600	200	Landscape	Do not use while intoxicated	1 / Pack
198171	148	210	Portrait	Do not use while intoxicated	1 / Pack
198172	210	297	Portrait	Do not use while intoxicated	1 / Pack
198173	297	420	Portrait	Do not use while intoxicated	1 / Pack
Polypropylene					
198174	150	50	Landscape	Do not use while intoxicated	1 / Pack
198175	297	105	Landscape	Do not use while intoxicated	1 / Pack
198176	450	150	Landscape	Do not use while intoxicated	1 / Pack
198177	600	200	Landscape	Do not use while intoxicated	1 / Pack
198178	148	210	Portrait	Do not use while intoxicated	1 / Pack
198179	210	297	Portrait	Do not use while intoxicated	1 / Pack
198180	297	420	Portrait	Do not use while intoxicated	1 / Pack
Aluminium					
198181	150	50	Landscape	Do not use while intoxicated	1 / Pack
198182	297	105	Landscape	Do not use while intoxicated	1 / Pack
198183	450	150	Landscape	Do not use while intoxicated	1 / Pack
198184	148	210	Portrait	Do not use while intoxicated	1 / Pack
198185	210	297	Portrait	Do not use while intoxicated	1 / Pack
198186	297	420	Portrait	Do not use while intoxicated	1 / Pack

PHOTOLUMINESCENT SIGNS



Order Ref.	Diameter (mm)	Total Qty/ Pack
Class B Photoluminescent Polyester		
198187	150	1 / Pack
Class C Photoluminescent Polyester		
198188	150	1 / Pack
Class B Photoluminescent Polypropylene		
198189	150	1 / Pack
Class C Photoluminescent Polypropylene		
198190	150	1 / Pack
Class C Photoluminescent Aluminium		
198191	150	1 / Pack

i For all material properties and applications, see pages 4-5

BRADY Customise-it See page 196 to order your custom-made signs.

Complies with EN ISO 7010

P044 : USE OF SMART GLASSES PROHIBITED

Clearly indicates that the wearing of smart glasses is not allowed at a facility for security or privacy reasons.



SIGNS

Order Ref.	Diameter (mm)	Total Qty/ Pack
Laminated Polyester		
198260	50	2 / Pack
198261	100	1 / Pack
198262	200	1 / Pack
198263	315	1 / Pack
Polypropylene		
198264	100	1 / Pack
198265	200	1 / Pack
198266	315	1 / Pack
Aluminium		
198267	100	1 / Pack
198268	200	1 / Pack
198269	315	1 / Pack

FLOOR MARKING

Order Ref.	Diameter (mm)	Total Qty/ Pack
Anti-skid Laminated Polyester		
198302	500	1 / Pack

MINI-PICTOGRAMS

Order Ref.	Diameter (mm)	Total Qty/ Pack
Laminated Polyester		
198296	20	18 / Pack
198297	25	7 / Pack
198298	30	15 / Pack
Vinyl		
198295	15	54 / Pack



PICTOGRAMS ON ROLLS

Order Ref.	Diameter (mm)	Total Qty/ Pack
Laminated Polyester		
198299	25	250 / Pack
198300	50	250 / Pack
198301	100	250 / Pack

SIGNS WITH TEXT

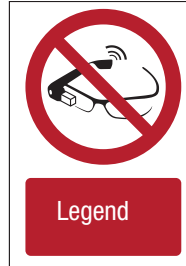

Order Ref.	Width (mm)	Height (mm)	Layout	Legend	Total Qty/ Pack
Laminated Polyester					
198270	150	50	Landscape	Do not use smart glasses	1 / Pack
198271	297	105	Landscape	Do not use smart glasses	1 / Pack
198272	450	150	Landscape	Do not use smart glasses	1 / Pack
198273	600	200	Landscape	Do not use smart glasses	1 / Pack
198274	148	210	Portrait	Do not use smart glasses	1 / Pack
198275	210	297	Portrait	Do not use smart glasses	1 / Pack
198276	297	420	Portrait	Do not use smart glasses	1 / Pack
Polypropylene					
198277	150	50	Landscape	Do not use smart glasses	1 / Pack
198278	297	105	Landscape	Do not use smart glasses	1 / Pack
198279	450	150	Landscape	Do not use smart glasses	1 / Pack
198280	600	200	Landscape	Do not use smart glasses	1 / Pack
198281	148	210	Portrait	Do not use smart glasses	1 / Pack
198282	210	297	Portrait	Do not use smart glasses	1 / Pack
198283	297	420	Portrait	Do not use smart glasses	1 / Pack
Aluminium					
198284	150	50	Landscape	Do not use smart glasses	1 / Pack
198285	297	105	Landscape	Do not use smart glasses	1 / Pack
198286	450	150	Landscape	Do not use smart glasses	1 / Pack
198287	148	210	Portrait	Do not use smart glasses	1 / Pack
198288	210	297	Portrait	Do not use smart glasses	1 / Pack
198289	297	420	Portrait	Do not use smart glasses	1 / Pack

PHOTOLUMINESCENT SIGNS



Order Ref.	Diameter (mm)	Total Qty/ Pack
Class B Photoluminescent Polyester		
198290	150	1 / Pack
Class C Photoluminescent Polyester		
198291	150	1 / Pack
Class B Photoluminescent Polypropylene		
198292	150	1 / Pack
Class C Photoluminescent Polypropylene		
198293	150	1 / Pack
Class C Photoluminescent Aluminium		
198294	150	1 / Pack

i For all material properties and applications, see pages 4-5

BRADY Customise-it See page 196 to order your custom-made signs.



P046 : Do NOT STRETCH OUT OF TOBOGGAN

This prohibition sign informs the general public of the proper code of conduct at a facility with a toboggan slide.



SIGNS

Order Ref.	Diameter (mm)	Total Qty/ Pack
Laminated Polyester		
197951	50	2 / Pack
197952	100	1 / Pack
197953	200	1 / Pack
197954	315	1 / Pack
Polypropylene		
197955	100	1 / Pack
197956	200	1 / Pack
197957	315	1 / Pack
Aluminium		
197958	100	1 / Pack
197959	200	1 / Pack
197960	315	1 / Pack

FLOOR MARKING

Order Ref.	Diameter (mm)	Total Qty/ Pack
Anti-skid Laminated Polyester		
197993	500	1 / Pack

MINI-PICTOGRAMS

Order Ref.	Diameter (mm)	Total Qty/ Pack
Laminated Polyester		
197987	20	18 / Pack
197988	25	7 / Pack
197989	30	15 / Pack
Vinyl		
197986	15	54 / Pack



PICTOGRAMS ON ROLLS

Order Ref.	Diameter (mm)	Total Qty/ Pack
Laminated Polyester		
197990	25	250 / Pack
197991	50	250 / Pack
197992	100	250 / Pack

SIGNS WITH TEXT



Order Ref.	Width (mm)	Height (mm)	Legend	Total Qty/ Pack
Laminated Polyester				
197961	150	50	Do not lean out of the toboggan	1 / Pack
197962	297	105	Do not lean out of the toboggan	1 / Pack
197963	450	150	Do not lean out of the toboggan	1 / Pack
197964	600	200	Do not lean out of the toboggan	1 / Pack
197965	148	210	Do not lean out of the toboggan	1 / Pack
197966	210	297	Do not lean out of the toboggan	1 / Pack
197967	297	420	Do not lean out of the toboggan	1 / Pack
Polypropylene				
197968	150	50	Do not lean out of the toboggan	1 / Pack
197969	297	105	Do not lean out of the toboggan	1 / Pack
197970	450	150	Do not lean out of the toboggan	1 / Pack
197971	600	200	Do not lean out of the toboggan	1 / Pack
197972	148	210	Do not lean out of the toboggan	1 / Pack
197973	210	297	Do not lean out of the toboggan	1 / Pack
197974	297	420	Do not lean out of the toboggan	1 / Pack
Aluminium				
197975	150	50	Do not lean out of the toboggan	1 / Pack
197976	297	105	Do not lean out of the toboggan	1 / Pack
197977	450	150	Do not lean out of the toboggan	1 / Pack
197978	148	210	Do not lean out of the toboggan	1 / Pack
197979	210	297	Do not lean out of the toboggan	1 / Pack
197980	297	420	Do not lean out of the toboggan	1 / Pack

PHOTOLUMINESCENT SIGNS



Order Ref.	Diameter (mm)	Total Qty/ Pack
Class B Photoluminescent Polyester		
197981	150	1 / Pack
Class C Photoluminescent Polyester		
197982	150	1 / Pack
Class B Photoluminescent Polypropylene		
197983	150	1 / Pack
Class C Photoluminescent Polypropylene		
197984	150	1 / Pack
Class C Photoluminescent Aluminium		
197985	150	1 / Pack

i For all material properties and applications, see pages 4-5

BRADY Customise-it See page 196 to order your custom-made signs.

Complies with EN ISO 7010

P047 : Do NOT RAM INTO TOBOGGAN

This prohibition sign informs the general public of the proper code of conduct at a facility with a toboggan slide.



SIGNS

Order Ref.	Diameter (mm)	Total Qty/ Pack
Laminated Polyester		
198054	50	2 / Pack
198055	100	1 / Pack
198056	200	1 / Pack
198057	315	1 / Pack
Polypropylene		
198058	100	1 / Pack
198059	200	1 / Pack
198060	315	1 / Pack
Aluminium		
198061	100	1 / Pack
198062	200	1 / Pack
198063	315	1 / Pack

FLOOR MARKING

Order Ref.	Diameter (mm)	Total Qty/ Pack
Anti-skid Laminated Polyester		
198096	500	1 / Pack

MINI-PICTOGRAMS

Order Ref.	Diameter (mm)	Total Qty/ Pack
Laminated Polyester		
198090	20	18 / Pack
198091	25	7 / Pack
198092	30	15 / Pack
Vinyl		
198089	15	54 / Pack



PICTOGRAMS ON ROLLS

Order Ref.	Diameter (mm)	Total Qty/ Pack
Laminated Polyester		
198093	25	250 / Pack
198094	50	250 / Pack
198095	100	250 / Pack

SIGNS WITH TEXT



Order Ref.	Width (mm)	Height (mm)	Legend	Total Qty/ Pack
Laminated Polyester				
198064	150	50	Do not ram into toboggan	1 / Pack
198065	297	105	Do not ram into toboggan	1 / Pack
198066	450	150	Do not ram into toboggan	1 / Pack
198067	600	200	Do not ram into toboggan	1 / Pack
198068	148	210	Do not ram into toboggan	1 / Pack
198069	210	297	Do not ram into toboggan	1 / Pack
198070	297	420	Do not ram into toboggan	1 / Pack
Polypropylene				
198071	150	50	Do not ram into toboggan	1 / Pack
198072	297	105	Do not ram into toboggan	1 / Pack
198073	450	150	Do not ram into toboggan	1 / Pack
198074	600	200	Do not ram into toboggan	1 / Pack
198075	148	210	Do not ram into toboggan	1 / Pack
198076	210	297	Do not ram into toboggan	1 / Pack
198077	297	420	Do not ram into toboggan	1 / Pack
Aluminium				
198078	150	50	Do not ram into toboggan	1 / Pack
198079	297	105	Do not ram into toboggan	1 / Pack
198080	450	150	Do not ram into toboggan	1 / Pack
198081	148	210	Do not ram into toboggan	1 / Pack
198082	210	297	Do not ram into toboggan	1 / Pack
198083	297	420	Do not ram into toboggan	1 / Pack

PHOTOLUMINESCENT SIGNS



Order Ref.	Diameter (mm)	Total Qty/ Pack
Class B Photoluminescent Polyester		
198084	150	1 / Pack
Class C Photoluminescent Polyester		
198085	150	1 / Pack
Class B Photoluminescent Polypropylene		
198086	150	1 / Pack
Class C Photoluminescent Polypropylene		
198087	150	1 / Pack
Class C Photoluminescent Aluminium		
198088	150	1 / Pack

i For all material properties and applications, see pages 4-5

BRADY Customise-it See page 196 to order your custom-made signs.



PIC 209 (=PIC 2110) : No ACCESS FOR UNAUTHORISED PERSONS

It is important to be able to limit access to certain spaces to authorised people. This limitation may be for safety reasons or just simply to keep some spaces 'private'.



SIGNS

Order Ref.	Diameter (mm)	Total Qty/Pack
Laminated Polyester		
250019	100	1 / Pack
250020	200	1 / Pack
222922	315	1 / Pack
Polypropylene		
222923	100	1 / Pack
Aluminium		
257999	100	1 / Pack
255016	200	1 / Pack
255017	315	1 / Pack

FLOOR MARKING

Order Ref.	Diameter (mm)	Total Qty/Pack
Anti-skid Laminated Polyester		
223653	500	1 / Pack

SIGNS WITH TEXT

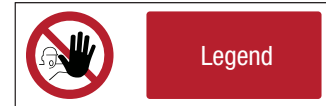

Order Ref.	Width (mm)	Height (mm)	Layout	Legend	Total Qty/Pack
Polypropylene					
195924	148	210	Portrait	No access for unauthorised persons	1 / Pack
195922	150	450	Portrait	No access for unauthorised persons	1 / Pack
195923	210	297	Portrait	No access for unauthorised persons	1 / Pack



PICTOGRAMS ON ROLLS

Order Ref.	Diameter (mm)	Total Qty/Pack
Laminated Polyester		
251960	25	250 / Roll
223325	50	250 / Roll
223326	100	250 / Roll

PHOTOLUMINESCENT SIGNS WITH TEXT



Order Ref.	Width (mm)	Height (mm)	Class	Legend	Total Qty/Pack
Class B Photoluminescent Polyester					
836127	200	100	Class B	No admittance Authorised personnel only	1 / Pack
836128	250	100	Class B	No admittance Authorised personnel only	1 / Pack
Class B Photoluminescent Polypropylene					
836125	200	100	Class B	No admittance Authorised personnel only	1 / Pack
836126	250	100	Class B	No admittance Authorised personnel only	1 / Pack



PIC 900 : No SMOKING OF ELECTRONIC CIGARETTES

With the appearance of electronic cigarettes, it has been necessary to clarify the places where they are prohibited or authorised, to avoid any confusion. For information, the texts of interior laws and regulations generally prohibit smoking, without defining the nature of this smoking. This ban therefore applies to tobacco cigarettes and to electronic cigarettes.



SIGNS

Order Ref.	Diameter (mm)	Total Qty/Pack
Laminated Polyester		
138478	100	1 Sign(s) / Pack
138479	200	1 Sign(s) / Pack
Polypropylene		
138480	100	1 Sign(s) / Pack
138481	200	1 Sign(s) / Pack

SIGNS WITH TEXT



PICTOGRAMS ON ROLLS

Order Ref.	Diameter (mm)	Total Qty/Pack
Laminated Polyester		
138477	50	250 / Pack

Order Ref.	Width (mm)	Height (mm)	Legend	Total Qty/Pack
Laminated Polyester				
138482	210	297	No smoking of electronic cigarettes	1 / Pack
Polypropylene				
138487	210	297	No smoking of electronic cigarettes	1 / Pack

TRAFFIC SIGNS

To encourage fluid and harmonised traffic flow between employees and visitors, Brady offers a range of parking signs which help with arrival, movement, directions, parking and accessibility for your space.

PIC 225 : NO PARKING



SIGNS

Order Ref.	Diameter (mm)	Total Qty/Pack
Laminated Polyester		
250051	100	1 / Pack
250052	200	1 / Pack
222928	315	1 / Pack
Polypropylene		
222929	100	1 / Pack
252049	200	1 / Pack
252050	315	1 / Pack
252051	400	1 / Pack
Aluminium		
241531	100	1 / Pack
241532	200	1 / Pack
241533	315	1 / Pack

FLOOR MARKING

Order Ref.	Diameter (mm)	Total Qty/Pack
Anti-skid Laminated Polyester		
223657	500	1 / Pack

PIC 228 : PROHIBITED FOR ALL TYPES OF VEHICLES



SIGNS

Order Ref.	Diameter (mm)	Total Qty/Pack
Laminated Polyester		
250057	100	1 / Pack
250058	200	1 / Pack
222926	315	1 / Pack
Polypropylene		
252059	315	1 / Pack
252060	400	1 / Pack
Aluminium		
241534	100	1 / Pack
241535	200	1 / Pack
255026	315	1 / Pack

PIC 226 : NO STOPPING (CLEARWAY)



SIGNS

Order Ref.	Diameter (mm)	Total Qty/Pack
Laminated Polyester		
250053	100	1 / Pack
250054	200	1 / Pack
222940	315	1 / Pack
Polypropylene		
252052	200	1 / Pack
252053	315	1 / Pack
252054	400	1 / Pack
Aluminium		
241548	100	1 / Pack
241549	200	1 / Pack
255024	315	1 / Pack

PIC 229 : NO ENTRY



SIGNS

Order Ref.	Diameter (mm)	Total Qty/Pack
Laminated Polyester		
250059	100	1 / Pack
250060	200	1 / Pack
222924	315	1 / Pack
Polypropylene		
222925	100	1 / Pack
252061	200	1 / Pack
252062	315	1 / Pack
252063	400	1 / Pack
Aluminium		
241529	100	1 / Pack
241530	200	1 / Pack
255027	315	1 / Pack

MINI-PICTOGRAMS

Order Ref.	Diameter (mm)	Total Qty/Pack
Vinyl		
286814	15	54 / Pack
286688	24	18 / Pack

FLOOR MARKING

Order Ref.	Diameter (mm)	Total Qty/Pack
Anti-skid Laminated Polyester		
223658	500	1 / Pack

PIC 227 : NO WAITING



SIGNS

Order Ref.	Diameter (mm)	Total Qty/Pack
Laminated Polyester		
250055	100	1 / Pack
250056	200	1 / Pack
222930	315	1 / Pack
Polypropylene		
252056	315	1 / Pack
252057	400	1 / Pack
Aluminium		
241550	100	1 / Pack
241551	200	1 / Pack
255025	315	1 / Pack

PICTOGRAMS ON ROLLS





















Order Ref.	Diameter (mm)	Total Qty/Pack
Laminated Polyester		
223345	25	250 / Roll
223346	50	250 / Roll
223347	100	250 / Roll

i For all material properties and applications, see pages 4-5

BRADY Customise-it See page 196 to order your custom-made signs.

Mandatory

Legend		
	M001 : General mandatory sign	155
	M002 : Refer to instruction manual/ booklet	156
	M003 : Wear ear protection	157
	M004 : Wear eye protection	158
	M005 : Connect an earth terminal to the ground	159
	M006 : Disconnect mains plug from electrical outlet	160
	M007 : Opaque eye protection must be worn	161
	M008 : Wear safety footwear	162
	M009 : Wear protective gloves	163
	M010 : Wear protective clothing	164
	M011 : Wash your hands	165
	M012 : Use handrail	166
	M013 : Wear face shield	167
	M014 : Wear head protection	168
	M015 : Wear high visibility clothing	169
	M016 : Wear a mask	170
	M017 : Wear respiratory protection	171
	M018 : Wear safety harness	172
	M019 : Wear welding mask	173
	M020 : Wear safety belts	174
	M021 : Disconnect before carrying out maintenance or repair	175

Legend		
	M022 : Use barrier cream	176
	M023 : Use footbridge	177
	M024 : Use this walkway	178
	M025 : Infants must be protected with opaque eye protection	179
	M026 : Use protective apron	180
	M027 : Check guard	181
	M028 : Keep locked	181
	M029 : Sound horn	182
	M030 : Use litter bin	182
	M031 : Use table saw adjustable guard	183
	M032 : Wear anti-static footwear	183
	M033 : Close safety bar of chairlift	184
	M034 : Open safety bar of chairlift	184
	M035 : Immediately leave the tow- track in the event of falling	185
	M036 : Lift ski tips	185
	M037 : Close and secure hatches in launch sequence	186
	M038 : Start engine in launch sequence	186
	M039 : Lower lifeboat to the water in launch sequence	187
	M040 : Lower liferaft to the water in launch sequence	187
	M041 : Lower rescue boat to the water in launch sequence	187
	M042 : Release falls in launch sequence	187

Legend		
	M043 : Start water spray in launch sequence	188
	M044 : Start air supply in launch sequence	188
	M045 : Release lifeboat gripes in launch sequence	188
	M046 : Secure gas cylinders	189
	M047 : Use self-contained breathing appliance	189
	M048 : Use gas detector	190
	M049 : Wear protective roll sport equipment	190
	M050 : Alighting from toboggan to the left	191
	M051 : Alighting from toboggan to the right	191
	M052 : Keep distances	192
	PIC 269 : Wear protective headgear	193
	PIC 280 : Wear protective footwear	192
	PIC 281 : Wear life jacket	194
	PIC 283 : Wear protective headgear	193
	PIC 286 : Wear hairnet	193
	PIC 1216 : Wheelchair access	194
	PIC 2209 : Wear lab coats	194
	PIC 2600 : Smoking allowed	195
	PIC 901 : Electronic cigarettes allowed	195

Complies with EN ISO 7010

M001 : GENERAL MANDATORY SIGN

The M001 obligation symbol is the most general and basic. For this reason, it must be positioned with a caption clarifying the obligation.



SIGNS

Order Ref.	Diameter (mm)	Total Qty/Pack
Laminated Polyester		
814160	50	2 / Pack
814162	100	1 / Pack
814163	200	1 / Pack
814164	315	1 / Pack
Polypropylene		
814166	100	1 / Pack
814167	200	1 / Pack
814168	315	1 / Pack
814169	400	1 / Pack
Aluminium		
814170	100	1 / Pack
814171	200	1 / Pack
814172	315	1 / Pack

MINI-PICTOGRAMS

Order Ref.	Diameter (mm)	Total Qty/Pack
Laminated Polyester		
814158	25	7 / Pack
Vinyl		
814156	15	54 / Pack



PICTOGRAMS ON ROLLS

Order Ref.	Diameter (mm)	Total Qty/Pack
Laminated Polyester		
814157	25	250 / Roll
814159	50	250 / Roll
814161	100	250 / Roll

i For all material properties and applications, see pages 4-5

BRADY Customise-it See page 196 to order your custom-made signs.

i



The M001 obligation symbol is the most general and basic. For this reason, it must be positioned with a caption clarifying the obligation.

The explanation next to the symbol may be printed using a Brady printer (see page 236)



SIGNS WITH TEXT



Order Ref.	Width (mm)	Height (mm)	Layout	Legend	Total Qty/Pack
Polypropylene					
814228	150	50	Landscape	Keep fire door shut	1 / Pack
814229	297	74	Landscape	Keep fire door shut	1 / Pack
814230	297	105	Landscape	Keep fire door shut	1 / Pack
814231	450	150	Landscape	Keep fire door shut	1 / Pack
814232	600	200	Landscape	Keep fire door shut	1 / Pack
814225	148	210	Portrait	Keep fire door shut	1 / Pack
814226	210	297	Portrait	Keep fire door shut	1 / Pack
814227	297	420	Portrait	Keep fire door shut	1 / Pack
Aluminium					
814236	150	50	Landscape	Keep fire door shut	1 / Pack
814237	297	105	Landscape	Keep fire door shut	1 / Pack
814238	450	150	Landscape	Keep fire door shut	1 / Pack
814233	148	210	Portrait	Keep fire door shut	1 / Pack
814234	210	297	Portrait	Keep fire door shut	1 / Pack
814235	297	420	Portrait	Keep fire door shut	1 / Pack
Laminated Polyester					
814220	150	50	Landscape	Keep fire door shut	1 / Pack
814221	297	74	Landscape	Keep fire door shut	1 / Pack
814222	297	105	Landscape	Keep fire door shut	1 / Pack
814223	450	150	Landscape	Keep fire door shut	1 / Pack
814224	600	200	Landscape	Keep fire door shut	1 / Pack
814217	148	210	Portrait	Keep fire door shut	1 / Pack
814218	210	297	Portrait	Keep fire door shut	1 / Pack
814219	297	420	Portrait	Keep fire door shut	1 / Pack

PHOTOLUMINESCENT SIGNS WITH TEXT



Order Ref.	Width (mm)	Height (mm)	Class	Legend	Total Qty/Pack
Class B Photoluminescent Polyester					
835541	100	100	Class B	Fire escape keep clear	1 / Pack
835581	100	100	Class B	This door to be kept shut when not in use	1 / Pack
835525	250	100	Class B	Employees only	1 / Pack
835527	250	100	Class B	Fire door keep locked	1 / Pack
835542	250	100	Class B	Fire escape keep clear	1 / Pack
835561	250	100	Class B	Automatic fire door keep clear	1 / Pack
Class B Photoluminescent Polypropylene					
835562	100	100	Class B	This door to be kept shut when not in use	1 / Pack
835524	250	100	Class B	Employees only	1 / Pack
835526	250	100	Class B	Fire door keep locked	1 / Pack
835529	250	100	Class B	Fire escape keep clear	1 / Pack





M002 : REFER TO INSTRUCTION MANUAL/BOOKLET

During first use or maintenance, reading the instructions is invaluable. It is therefore a good idea to remind operators.



SIGNS

Order Ref.	Diameter (mm)	Total Qty/Pack
Laminated Polyester		
818120	50	2 / Pack
818122	100	1 / Pack
818123	200	1 / Pack
818124	315	1 / Pack
Polypropylene		
818126	100	1 / Pack
818127	200	1 / Pack
818128	315	1 / Pack
818129	400	1 / Pack
Aluminium		
818130	100	1 / Pack
818131	200	1 / Pack
818132	315	1 / Pack

MINI-PICTOGRAMS

Order Ref.	Diameter (mm)	Total Qty/Pack
Laminated Polyester		
818118	25	7 / Pack
138994	30	15 / Pack
Vinyl		
818116	15	54 / Pack



PICTOGRAMS ON ROLLS

Order Ref.	Diameter (mm)	Total Qty/Pack
Laminated Polyester		
818117	25	250 / Roll
818119	50	250 / Roll
818121	100	250 / Roll



PHOTOLUMINESCENT SIGNS

Order Ref.	Diameter (mm)	Class	Total Qty/Pack
Class B Photoluminescent Polyester			
835595	150	Class B	1 / Pack
Class C Photoluminescent Polyester			
835600	150	Class C	1 / Pack
Class B Photoluminescent Polypropylene			
835590	150	Class B	1 / Pack
Class C Photoluminescent Polypropylene			
835593	150	Class C	1 / Pack
Class C Photoluminescent Aluminium			
835582	150	Class C	1 / Pack

SIGNS WITH TEXT



Order Ref.	Width (mm)	Height (mm)	Layout	Legend	Total Qty/Pack
Polypropylene					
818188	150	50	Land-scape	Refer to instruction manual/booklet	1 / Pack
818189	297	74	Land-scape	Refer to instruction manual/booklet	1 / Pack
818190	297	105	Land-scape	Refer to instruction manual/booklet	1 / Pack
818191	450	150	Land-scape	Refer to instruction manual/booklet	1 / Pack
818192	600	200	Land-scape	Refer to instruction manual/booklet	1 / Pack
818185	148	210	Portrait	Refer to instruction manual/booklet	1 / Pack
818186	210	297	Portrait	Refer to instruction manual/booklet	1 / Pack
818187	297	420	Portrait	Refer to instruction manual/booklet	1 / Pack
Aluminium					
818196	150	50	Land-scape	Refer to instruction manual/booklet	1 / Pack
818197	297	105	Land-scape	Refer to instruction manual/booklet	1 / Pack
818198	450	150	Land-scape	Refer to instruction manual/booklet	1 / Pack
818193	148	210	Portrait	Refer to instruction manual/booklet	1 / Pack
818194	210	297	Portrait	Refer to instruction manual/booklet	1 / Pack
818195	297	420	Portrait	Refer to instruction manual/booklet	1 / Pack
Laminated Polyester					
818180	150	50	Land-scape	Refer to instruction manual/booklet	1 / Pack
818181	297	74	Land-scape	Refer to instruction manual/booklet	1 / Pack
818182	297	105	Land-scape	Refer to instruction manual/booklet	1 / Pack
818183	450	150	Land-scape	Refer to instruction manual/booklet	1 / Pack
818184	600	200	Land-scape	Refer to instruction manual/booklet	1 / Pack
818177	148	210	Portrait	Refer to instruction manual/booklet	1 / Pack
818178	210	297	Portrait	Refer to instruction manual/booklet	1 / Pack
818179	297	420	Portrait	Refer to instruction manual/booklet	1 / Pack

i For all material properties and applications, see pages 4-5

BRADY Customise-it See page 196 to order your custom-made signs.

Complies with EN ISO 7010

M003 : WEAR EAR PROTECTION

To protect the health and hearing of workers, hearing protection must be worn in case of exposure to significant or continuous noise.



SIGNS

Order Ref.	Diameter (mm)	Total Qty/Pack
Laminated Polyester		
818269	50	2 / Pack
818271	100	1 / Pack
818272	200	1 / Pack
818273	315	1 / Pack
Polypropylene		
818275	100	1 / Pack
818276	200	1 / Pack
818277	315	1 / Pack
818278	400	1 / Pack
Aluminium		
818279	100	1 / Pack
818280	200	1 / Pack
818281	315	1 / Pack

FLOOR MARKING

Order Ref.	Diameter (mm)	Total Qty/Pack
Anti-skid Laminated Polyester		
818274	500	1 / Pack

MINI-PICTOGRAMS

Order Ref.	Diameter (mm)	Total Qty/Pack
Laminated Polyester		
138970	24	18 / Pack
818267	25	7 / Pack
Vinyl		
818265	15	54 / Pack



PICTOGRAMS ON ROLLS

Order Ref.	Diameter (mm)	Total Qty/Pack
Laminated Polyester		
818266	25	250 / Roll
818268	50	250 / Roll
818270	100	250 / Roll

i For all material properties and applications, see pages 4-5

BRADY Customise-it See page 196 to order your custom-made signs.

SIGNS WITH TEXT



Order Ref.	Width (mm)	Height (mm)	Layout	Legend	Total Qty/Pack
Polypropylene					
818337	150	50	Landscape	Wear ear protection	1 / Pack
818338	297	74	Landscape	Wear ear protection	1 / Pack
818339	297	105	Landscape	Wear ear protection	1 / Pack
818340	450	150	Landscape	Wear ear protection	1 / Pack
818341	600	200	Landscape	Wear ear protection	1 / Pack
818334	148	210	Portrait	Wear ear protection	1 / Pack
818335	210	297	Portrait	Wear ear protection	1 / Pack
818336	297	420	Portrait	Wear ear protection	1 / Pack
Aluminium					
818345	150	50	Landscape	Wear ear protection	1 / Pack
818346	297	105	Landscape	Wear ear protection	1 / Pack
818347	450	150	Landscape	Wear ear protection	1 / Pack
818342	148	210	Portrait	Wear ear protection	1 / Pack
818343	210	297	Portrait	Wear ear protection	1 / Pack
818344	297	420	Portrait	Wear ear protection	1 / Pack
Laminated Polyester					
818329	150	50	Landscape	Wear ear protection	1 / Pack
818330	297	74	Landscape	Wear ear protection	1 / Pack
818331	297	105	Landscape	Wear ear protection	1 / Pack
818332	450	150	Landscape	Wear ear protection	1 / Pack
818333	600	200	Landscape	Wear ear protection	1 / Pack
818326	148	210	Portrait	Wear ear protection	1 / Pack
818327	210	297	Portrait	Wear ear protection	1 / Pack
818328	297	420	Portrait	Wear ear protection	1 / Pack

PHOTOLUMINESCENT SIGNS



Order Ref.	Diameter (mm)	Class	Total Qty/Pack
Class B Photoluminescent Polyester			
836745	150	Class B	1 / Pack
836746	200	Class B	1 / Pack

PHOTOLUMINESCENT SIGNS WITH TEXT



Order Ref.	Width (mm)	Height (mm)	Class	Legend	Total Qty/Pack
Class B Photoluminescent Polyester					
835611	250	100	Class B	Ear protectors must be worn in this area	1 / Pack
835615	300	400	Class B	Ear protectors must be worn in this area	1 / Pack
Class B Photoluminescent Polypropylene					
835601	250	100	Class B	Ear protectors must be worn in this area	1 / Pack
835609	300	400	Class B	Ear protectors must be worn in this area	1 / Pack



M004 : WEAR EYE PROTECTION

For certain interventions or tasks, wearing protective glasses may save a worker's sight. Reminding people of this PPE obligation will help them to remember and to wear the right equipment.



SIGNS

Order Ref.	Diameter (mm)	Total Qty/Pack
Laminated Polyester		
818418	50	2 / Pack
818420	100	1 / Pack
818421	200	1 / Pack
818422	315	1 / Pack
Polypropylene		
818424	100	1 / Pack
818425	200	1 / Pack
818426	315	1 / Pack
818427	400	1 / Pack
Aluminium		
818428	100	1 / Pack
818429	200	1 / Pack
818430	315	1 / Pack

FLOOR MARKING

Order Ref.	Diameter (mm)	Total Qty/Pack
Anti-skid Laminated Polyester		
818423	500	1 / Pack

MINI-PICTOGRAMS

Order Ref.	Diameter (mm)	Total Qty/Pack
Laminated Polyester		
139139	24	18 / Pack
818416	25	7 / Pack
Vinyl		
818414	15	54 / Pack

PICTOGRAMS ON ROLLS

Order Ref.	Diameter (mm)	Total Qty/Pack
Laminated Polyester		
818415	25	250 / Roll
818417	50	250 / Roll
818419	100	250 / Roll



i For all material properties and applications, see pages 4-5

BRADY Customise-it

See page 196 to order your custom-made signs.

SIGNS WITH TEXT



Order Ref.	Width (mm)	Height (mm)	Layout	Legend	Total Qty/Pack
Polypropylene					
818486	150	50	Landscape	Wear eye protection	1 / Pack
818487	297	74	Landscape	Wear eye protection	1 / Pack
818488	297	105	Landscape	Wear eye protection	1 / Pack
818489	450	150	Landscape	Wear eye protection	1 / Pack
818490	600	200	Landscape	Wear eye protection	1 / Pack
818483	148	210	Portrait	Wear eye protection	1 / Pack
818484	210	297	Portrait	Wear eye protection	1 / Pack
818485	297	420	Portrait	Wear eye protection	1 / Pack
Aluminium					
818494	150	50	Landscape	Wear eye protection	1 / Pack
818495	297	105	Landscape	Wear eye protection	1 / Pack
818496	450	150	Landscape	Wear eye protection	1 / Pack
818491	148	210	Portrait	Wear eye protection	1 / Pack
818492	210	297	Portrait	Wear eye protection	1 / Pack
818493	297	420	Portrait	Wear eye protection	1 / Pack
Laminated Polyester					
818478	150	50	Landscape	Wear eye protection	1 / Pack
818479	297	74	Landscape	Wear eye protection	1 / Pack
818480	297	105	Landscape	Wear eye protection	1 / Pack
818481	450	150	Landscape	Wear eye protection	1 / Pack
818482	600	200	Landscape	Wear eye protection	1 / Pack
818475	148	210	Portrait	Wear eye protection	1 / Pack
818476	210	297	Portrait	Wear eye protection	1 / Pack
818477	297	420	Portrait	Wear eye protection	1 / Pack



PHOTOLUMINESCENT SIGNS

Order Ref.	Diameter (mm)	Class	Total Qty/Pack
Class B Photoluminescent Polyester			
836747	150	Class B	1 / Pack
836748	200	Class B	1 / Pack

PHOTOLUMINESCENT SIGNS WITH TEXT



Order Ref.	Width (mm)	Height (mm)	Class	Legend	Total Qty/Pack
Class B Photoluminescent Polyester					
835620	300	400	Class B	Eye protection must be worn	1 / Pack
Class B Photoluminescent Polypropylene					
835618	300	400	Class B	Eye protection must be worn	1 / Pack

Complies with EN ISO 7010

M005 : CONNECT AN EARTH TERMINAL TO THE GROUND

Earthing may be obligatory to avoid an accident, so it is worth stating this in this context.

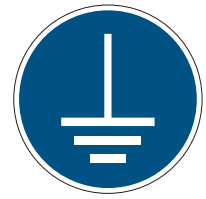

SIGNS

Order Ref.	Diameter (mm)	Total Qty/Pack
Laminated Polyester		
818567	50	2 / Pack
818569	100	1 / Pack
818570	200	1 / Pack
818571	315	1 / Pack
Polypropylene		
818573	100	1 / Pack
818574	200	1 / Pack
818575	315	1 / Pack
818576	400	1 / Pack
Aluminium		
818577	100	1 / Pack
818578	200	1 / Pack
818579	315	1 / Pack

FLOOR MARKING

Order Ref.	Diameter (mm)	Total Qty/Pack
Anti-skid Laminated Polyester		
818572	500	1 / Pack

MINI-PICTOGRAMS

Order Ref.	Diameter (mm)	Total Qty/Pack
Laminated Polyester		
818565	25	7 / Pack
Vinyl		
818563	15	54 / Pack



PICTOGRAMS ON ROLLS

Order Ref.	Diameter (mm)	Total Qty/Pack
Laminated Polyester		
818564	25	250 / Roll
818566	50	250 / Roll
818568	100	250 / Roll

i For all material properties and applications, see pages 4-5

BRADY Customise-it See page 196 to order your custom-made signs.

SIGNS WITH TEXT



Order Ref.	Width (mm)	Height (mm)	Layout	Legend	Total Qty/Pack
Polypropylene					
818635	150	50	Landscape	Connect an earth terminal to the ground	1 / Pack
818636	297	74	Landscape	Connect an earth terminal to the ground	1 / Pack
818637	297	105	Landscape	Connect an earth terminal to the ground	1 / Pack
818638	450	150	Landscape	Connect an earth terminal to the ground	1 / Pack
818639	600	200	Landscape	Connect an earth terminal to the ground	1 / Pack
818632	148	210	Portrait	Connect an earth terminal to the ground	1 / Pack
818633	210	297	Portrait	Connect an earth terminal to the ground	1 / Pack
818634	297	420	Portrait	Connect an earth terminal to the ground	1 / Pack
Aluminium					
818643	150	50	Landscape	Connect an earth terminal to the ground	1 / Pack
818644	297	105	Landscape	Connect an earth terminal to the ground	1 / Pack
818645	450	150	Landscape	Connect an earth terminal to the ground	1 / Pack
818640	148	210	Portrait	Connect an earth terminal to the ground	1 / Pack
818641	210	297	Portrait	Connect an earth terminal to the ground	1 / Pack
818642	297	420	Portrait	Connect an earth terminal to the ground	1 / Pack
Laminated Polyester					
818627	150	50	Landscape	Connect an earth terminal to the ground	1 / Pack
818628	297	74	Landscape	Connect an earth terminal to the ground	1 / Pack
818629	297	105	Landscape	Connect an earth terminal to the ground	1 / Pack
818630	450	150	Landscape	Connect an earth terminal to the ground	1 / Pack
818631	600	200	Landscape	Connect an earth terminal to the ground	1 / Pack
818624	148	210	Portrait	Connect an earth terminal to the ground	1 / Pack
818625	210	297	Portrait	Connect an earth terminal to the ground	1 / Pack
818626	297	420	Portrait	Connect an earth terminal to the ground	1 / Pack



PHOTOLUMINESCENT SIGNS

Order Ref.	Diameter (mm)	Class	Total Qty/Pack
Class B Photoluminescent Polyester			
835634	150	Class B	1 / Pack
Class C Photoluminescent Polyester			
835635	150	Class C	1 / Pack
Class B Photoluminescent Polypropylene			
835626	150	Class B	1 / Pack
Class C Photoluminescent Polypropylene			
835633	150	Class C	1 / Pack
Class C Photoluminescent Aluminium			
835624	150	Class C	1 / Pack

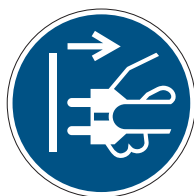

M006 : DISCONNECT MAINS PLUG FROM ELECTRICAL OUTLET

As part of certain maintenance procedures, it is imperative to disconnect a machine from the sector. This symbol makes it possible to repeat this in a simpler and easier fashion.



SIGNS

Order Ref.	Diameter (mm)	Total Qty/Pack
Laminated Polyester		
818716	50	2 / Pack
818718	100	1 / Pack
818719	200	1 / Pack
818720	315	1 / Pack
Polypropylene		
818722	100	1 / Pack
818723	200	1 / Pack
818724	315	1 / Pack
818725	400	1 / Pack
Aluminium		
818726	100	1 / Pack
818727	200	1 / Pack
818728	315	1 / Pack

FLOOR MARKING

Order Ref.	Diameter (mm)	Total Qty/Pack
Anti-skid Laminated Polyester		
818721	500	1 / Pack

MINI-PICTOGRAMS

Order Ref.	Diameter (mm)	Total Qty/Pack
Laminated Polyester		
818714	25	7 / Pack
Vinyl		
818712	15	54 / Pack



PICTOGRAMS ON ROLLS

Order Ref.	Diameter (mm)	Total Qty/Pack
Laminated Polyester		
818713	25	250 / Roll
818715	50	250 / Roll
818717	100	250 / Roll



PHOTOLUMINESCENT SIGNS

Order Ref.	Diameter (mm)	Class	Total Qty/Pack
Class B Photoluminescent Polyester			
835641	150	Class B	1 / Pack
Class C Photoluminescent Polyester			
835642	150	Class C	1 / Pack
Class B Photoluminescent Polypropylene			
835637	150	Class B	1 / Pack
Class C Photoluminescent Polypropylene			
835638	150	Class C	1 / Pack
Class C Photoluminescent Aluminium			
835636	150	Class C	1 / Pack

SIGNS WITH TEXT



Order Ref.	Width (mm)	Height (mm)	Layout	Legend	Total Qty/Pack
Polypropylene					
818784	150	50	Landscape	Disconnect mains plug from electrical outlet	1 / Pack
818785	297	74	Landscape	Disconnect mains plug from electrical outlet	1 / Pack
818786	297	105	Landscape	Disconnect mains plug from electrical outlet	1 / Pack
818787	450	150	Landscape	Disconnect mains plug from electrical outlet	1 / Pack
818788	600	200	Landscape	Disconnect mains plug from electrical outlet	1 / Pack
818781	148	210	Portrait	Disconnect mains plug from electrical outlet	1 / Pack
818782	210	297	Portrait	Disconnect mains plug from electrical outlet	1 / Pack
818783	297	420	Portrait	Disconnect mains plug from electrical outlet	1 / Pack
Aluminium					
818792	150	50	Landscape	Disconnect mains plug from electrical outlet	1 / Pack
818793	297	105	Landscape	Disconnect mains plug from electrical outlet	1 / Pack
818794	450	150	Landscape	Disconnect mains plug from electrical outlet	1 / Pack
818789	148	210	Portrait	Disconnect mains plug from electrical outlet	1 / Pack
818790	210	297	Portrait	Disconnect mains plug from electrical outlet	1 / Pack
818791	297	420	Portrait	Disconnect mains plug from electrical outlet	1 / Pack
Laminated Polyester					
818776	150	50	Landscape	Disconnect mains plug from electrical outlet	1 / Pack
818777	297	74	Landscape	Disconnect mains plug from electrical outlet	1 / Pack
818778	297	105	Landscape	Disconnect mains plug from electrical outlet	1 / Pack
818779	450	150	Landscape	Disconnect mains plug from electrical outlet	1 / Pack
818780	600	200	Landscape	Disconnect mains plug from electrical outlet	1 / Pack
818773	148	210	Portrait	Disconnect mains plug from electrical outlet	1 / Pack
818774	210	297	Portrait	Disconnect mains plug from electrical outlet	1 / Pack
818775	297	420	Portrait	Disconnect mains plug from electrical outlet	1 / Pack

i For all material properties and applications, see pages 4-5

BRADY Customise-it See page 196 to order your custom-made signs.

Complies with EN ISO 7010

M007 : OPAQUE EYE PROTECTION MUST BE WORN

Light-blocking protective glasses are sometimes obligatory to protect oneself against particularly aggressive and harmful rays.



SIGNS

Order Ref.	Diameter (mm)	Total Qty/Pack
Laminated Polyester		
818865	50	2 / Pack
818867	100	1 / Pack
818868	200	1 / Pack
818869	315	1 / Pack
Polypropylene		
818871	100	1 / Pack
818872	200	1 / Pack
818873	315	1 / Pack
818874	400	1 / Pack
Aluminium		
818875	100	1 / Pack
818876	200	1 / Pack
818877	315	1 / Pack

MINI-PICTOGRAMS

Order Ref.	Diameter (mm)	Total Qty/Pack
Laminated Polyester		
818863	25	7 / Pack
Vinyl		
818861	15	54 / Pack



PICTOGRAMS ON ROLLS

Order Ref.	Diameter (mm)	Total Qty/Pack
Laminated Polyester		
818862	25	250 / Roll
818864	50	250 / Roll
818866	100	250 / Roll



PHOTOLUMINESCENT SIGNS

Order Ref.	Diameter (mm)	Class	Total Qty/Pack
Class B Photoluminescent Polyester			
835649	150	Class B	1 / Pack
Class C Photoluminescent Polyester			
835650	150	Class C	1 / Pack
Class B Photoluminescent Polypropylene			
835647	150	Class B	1 / Pack
Class C Photoluminescent Polypropylene			
835648	150	Class C	1 / Pack
Class C Photoluminescent Aluminium			
835646	150	Class C	1 / Pack

SIGNS WITH TEXT



Order Ref.	Width (mm)	Height (mm)	Layout	Legend	Total Qty/Pack
Polypropylene					
818933	150	50	Landscape	Wear opaque eye protection	1 / Pack
818934	297	74	Landscape	Wear opaque eye protection	1 / Pack
818935	297	105	Landscape	Wear opaque eye protection	1 / Pack
818936	450	150	Landscape	Wear opaque eye protection	1 / Pack
818937	600	200	Landscape	Wear opaque eye protection	1 / Pack
818930	148	210	Portrait	Wear opaque eye protection	1 / Pack
818931	210	297	Portrait	Wear opaque eye protection	1 / Pack
818932	297	420	Portrait	Wear opaque eye protection	1 / Pack
Aluminium					
818941	150	50	Landscape	Wear opaque eye protection	1 / Pack
818942	297	105	Landscape	Wear opaque eye protection	1 / Pack
818943	450	150	Landscape	Wear opaque eye protection	1 / Pack
818938	148	210	Portrait	Wear opaque eye protection	1 / Pack
818939	210	297	Portrait	Wear opaque eye protection	1 / Pack
818940	297	420	Portrait	Wear opaque eye protection	1 / Pack
Laminated Polyester					
818925	150	50	Landscape	Wear opaque eye protection	1 / Pack
818926	297	74	Landscape	Wear opaque eye protection	1 / Pack
818927	297	105	Landscape	Wear opaque eye protection	1 / Pack
818928	450	150	Landscape	Wear opaque eye protection	1 / Pack
818929	600	200	Landscape	Wear opaque eye protection	1 / Pack
818922	148	210	Portrait	Wear opaque eye protection	1 / Pack
818923	210	297	Portrait	Wear opaque eye protection	1 / Pack
818924	297	420	Portrait	Wear opaque eye protection	1 / Pack

i For all material properties and applications, see pages 4-5

BRADY Customise-it See page 196 to order your custom-made signs.



M008 : WEAR SAFETY FOOTWEAR

Thanks to their metal tip, safety boots prevent numerous injuries, from impact and crushing. Wearing them is compulsory on many industrial sites.



SIGNS

Order Ref.	Diameter (mm)	Total Qty/Pack
Laminated Polyester		
819014	50	2 / Pack
819016	100	1 / Pack
819017	200	1 / Pack
819018	315	1 / Pack
Polypropylene		
819020	100	1 / Pack
819021	200	1 / Pack
819022	315	1 / Pack
819023	400	1 / Pack
Aluminium		
819024	100	1 / Pack
819025	200	1 / Pack
819026	315	1 / Pack

FLOOR MARKING

Order Ref.	Diameter (mm)	Total Qty/Pack
Anti-skid Laminated Polyester		
819019	500	1 / Pack

MINI-PICTOGRAMS

Order Ref.	Diameter (mm)	Total Qty/Pack
Laminated Polyester		
138972	24	18 / Pack
819012	25	7 / Pack
Vinyl		
819010	15	54 / Pack

SIGNS WITH TEXT



Order Ref.	Width (mm)	Height (mm)	Layout	Legend	Total Qty/Pack
Polypropylene					
819082	150	50	Landscape	Wear safety footwear	1 / Pack
819083	297	74	Landscape	Wear safety footwear	1 / Pack
819084	297	105	Landscape	Wear safety footwear	1 / Pack
819085	450	150	Landscape	Wear safety footwear	1 / Pack
819086	600	200	Landscape	Wear safety footwear	1 / Pack
819079	148	210	Portrait	Wear safety footwear	1 / Pack
819080	210	297	Portrait	Wear safety footwear	1 / Pack
819081	297	420	Portrait	Wear safety footwear	1 / Pack
Aluminium					
819090	150	50	Landscape	Wear safety footwear	1 / Pack
819091	297	105	Landscape	Wear safety footwear	1 / Pack
819092	450	150	Landscape	Wear safety footwear	1 / Pack
819087	148	210	Portrait	Wear safety footwear	1 / Pack
819088	210	297	Portrait	Wear safety footwear	1 / Pack
819089	297	420	Portrait	Wear safety footwear	1 / Pack
Laminated Polyester					
819074	150	50	Landscape	Wear safety footwear	1 / Pack
819075	297	74	Landscape	Wear safety footwear	1 / Pack
819076	297	105	Landscape	Wear safety footwear	1 / Pack
819077	450	150	Landscape	Wear safety footwear	1 / Pack
819078	600	200	Landscape	Wear safety footwear	1 / Pack
819071	148	210	Portrait	Wear safety footwear	1 / Pack
819072	210	297	Portrait	Wear safety footwear	1 / Pack
819073	297	420	Portrait	Wear safety footwear	1 / Pack



PICTOGRAMS ON ROLLS

Order Ref.	Diameter (mm)	Total Qty/Pack
Laminated Polyester		
819011	25	250 / Roll
819013	50	250 / Roll
819015	100	250 / Roll



PHOTOLUMINESCENT SIGNS

Order Ref.	Diameter (mm)	Class	Total Qty/Pack
Class B Photoluminescent Polyester			
835656	150	Class B	1 / Pack
Class C Photoluminescent Polyester			
835657	150	Class C	1 / Pack
Class B Photoluminescent Polypropylene			
835654	150	Class B	1 / Pack
Class C Photoluminescent Polypropylene			
835655	150	Class C	1 / Pack
Class C Photoluminescent Aluminium			
835653	150	Class C	1 / Pack

i For all material properties and applications, see pages 4-5

BRADY Customise-it See page 196 to order your custom-made signs.

Complies with EN ISO 7010

MO09 : WEAR PROTECTIVE GLOVES

Protective gloves, depending on which kind, may protect from heat, cold, cuts, etc. Choosing them well and wearing them reinforces the safety of hands and therefore that of the employee.



SIGNS

Order Ref.	Diameter (mm)	Total Qty/Pack
Laminated Polyester		
819163	50	2 / Pack
819165	100	1 / Pack
819166	200	1 / Pack
819167	315	1 / Pack
Polypropylene		
819169	100	1 / Pack
819170	200	1 / Pack
819171	315	1 / Pack
819172	400	1 / Pack
Aluminium		
819173	100	1 / Pack
819174	200	1 / Pack
819175	315	1 / Pack

FLOOR MARKING

Order Ref.	Diameter (mm)	Total Qty/Pack
Anti-skid Laminated Polyester		
819168	500	1 / Pack

MINI-PICTOGRAMS

Order Ref.	Diameter (mm)	Total Qty/Pack
Laminated Polyester		
138971	24	18 / Pack
819161	25	7 / Pack
Vinyl		
819159	15	54 / Pack

SIGNS WITH TEXT



Order Ref.	Width (mm)	Height (mm)	Layout	Legend	Total Qty/Pack
Polypropylene					
819231	150	50	Landscape	Wear protective gloves	1 / Pack
819232	297	74	Landscape	Wear protective gloves	1 / Pack
819233	297	105	Landscape	Wear protective gloves	1 / Pack
819234	450	150	Landscape	Wear protective gloves	1 / Pack
819235	600	200	Landscape	Wear protective gloves	1 / Pack
819228	148	210	Portrait	Wear protective gloves	1 / Pack
819229	210	297	Portrait	Wear protective gloves	1 / Pack
819230	297	420	Portrait	Wear protective gloves	1 / Pack
Aluminium					
819239	150	50	Landscape	Wear protective gloves	1 / Pack
819240	297	105	Landscape	Wear protective gloves	1 / Pack
819241	450	150	Landscape	Wear protective gloves	1 / Pack
819236	148	210	Portrait	Wear protective gloves	1 / Pack
819237	210	297	Portrait	Wear protective gloves	1 / Pack
819238	297	420	Portrait	Wear protective gloves	1 / Pack
Laminated Polyester					
819223	150	50	Landscape	Wear protective gloves	1 / Pack
819224	297	74	Landscape	Wear protective gloves	1 / Pack
819225	297	105	Landscape	Wear protective gloves	1 / Pack
819226	450	150	Landscape	Wear protective gloves	1 / Pack
819227	600	200	Landscape	Wear protective gloves	1 / Pack
819220	148	210	Portrait	Wear protective gloves	1 / Pack
819221	210	297	Portrait	Wear protective gloves	1 / Pack
819222	297	420	Portrait	Wear protective gloves	1 / Pack



PICTOGRAMS ON ROLLS

Order Ref.	Diameter (mm)	Total Qty/Pack
Laminated Polyester		
819160	25	250 / Roll
819162	50	250 / Roll
819164	100	250 / Roll



PHOTOLUMINESCENT SIGNS

Order Ref.	Diameter (mm)	Class	Total Qty/Pack
Class B Photoluminescent Polyester			
835663	150	Class B	1 / Pack
Class C Photoluminescent Polyester			
835664	150	Class C	1 / Pack
Class B Photoluminescent Polypropylene			
835661	150	Class B	1 / Pack
Class C Photoluminescent Polypropylene			
835662	150	Class C	1 / Pack
Class C Photoluminescent Aluminium			
835660	150	Class C	1 / Pack

i For all material properties and applications, see pages 4-5

BRADY Customise-it See page 196 to order your custom-made signs.



PHOTOLUMINESCENT SIGNS WITH TEXT

Order Ref.	Width (mm)	Height (mm)	Class	Legend	Total Qty/Pack
Class B Photoluminescent Polyester					
835659	300	400	Class B	Hand protection must be worn	1 / Pack
Class B Photoluminescent Polypropylene					
835658	300	400	Class B	Hand protection must be worn	1 / Pack



M010 : WEAR PROTECTIVE CLOTHING

Depending on the work involved, clothing is made available to workers for their protection and occasionally that of the products being manufactured.



SIGNS

Order Ref.	Diameter (mm)	Total Qty/Pack
Laminated Polyester		
819312	50	2 / Pack
819314	100	1 / Pack
819315	200	1 / Pack
819316	315	1 / Pack
Polypropylene		
819318	100	1 / Pack
819319	200	1 / Pack
819320	315	1 / Pack
819321	400	1 / Pack
Aluminium		
819322	100	1 / Pack
819323	200	1 / Pack
819324	315	1 / Pack

FLOOR MARKING

Order Ref.	Diameter (mm)	Total Qty/Pack
Anti-skid Laminated Polyester		
819317	500	1 / Pack

MINI-PICTOGRAMS

Order Ref.	Diameter (mm)	Total Qty/Pack
Laminated Polyester		
138991	20	18 / Pack
819310	25	7 / Pack
Vinyl		
819308	15	54 / Pack

SIGNS WITH TEXT



Order Ref.	Width (mm)	Height (mm)	Layout	Legend	Total Qty/Pack
Polypropylene					
819380	150	50	Landscape	Wear protective clothing	1 / Pack
819381	297	74	Landscape	Wear protective clothing	1 / Pack
819382	297	105	Landscape	Wear protective clothing	1 / Pack
819383	450	150	Landscape	Wear protective clothing	1 / Pack
819384	600	200	Landscape	Wear protective clothing	1 / Pack
819377	148	210	Portrait	Wear protective clothing	1 / Pack
819378	210	297	Portrait	Wear protective clothing	1 / Pack
819379	297	420	Portrait	Wear protective clothing	1 / Pack
Aluminium					
819388	150	50	Landscape	Wear protective clothing	1 / Pack
819389	297	105	Landscape	Wear protective clothing	1 / Pack
819390	450	150	Landscape	Wear protective clothing	1 / Pack
819385	148	210	Portrait	Wear protective clothing	1 / Pack
819386	210	297	Portrait	Wear protective clothing	1 / Pack
819387	297	420	Portrait	Wear protective clothing	1 / Pack
Laminated Polyester					
819372	150	50	Landscape	Wear protective clothing	1 / Pack
819373	297	74	Landscape	Wear protective clothing	1 / Pack
819374	297	105	Landscape	Wear protective clothing	1 / Pack
819375	450	150	Landscape	Wear protective clothing	1 / Pack
819376	600	200	Landscape	Wear protective clothing	1 / Pack
819369	148	210	Portrait	Wear protective clothing	1 / Pack
819370	210	297	Portrait	Wear protective clothing	1 / Pack
819371	297	420	Portrait	Wear protective clothing	1 / Pack



PICTOGRAMS ON ROLLS

Order Ref.	Diameter (mm)	Total Qty/Pack
Laminated Polyester		
819309	25	250 / Roll
819311	50	250 / Roll
819313	100	250 / Roll



PHOTOLUMINESCENT SIGNS

Order Ref.	Diameter (mm)	Class	Total Qty/Pack
Class B Photoluminescent Polyester			
835670	150	Class B	1 / Pack
Class C Photoluminescent Polyester			
835671	150	Class C	1 / Pack
Class B Photoluminescent Polypropylene			
835668	150	Class B	1 / Pack
Class C Photoluminescent Polypropylene			
835669	150	Class C	1 / Pack
Class C Photoluminescent Aluminium			
835667	150	Class C	1 / Pack

i For all material properties and applications, see pages 4-5

BRADY Customise-it See page 196 to order your custom-made signs.



PHOTOLUMINESCENT SIGNS WITH TEXT

Order Ref.	Width (mm)	Height (mm)	Class	Legend	Total Qty/Pack
Class B Photoluminescent Polyester					
835666	250	100	Class B	Wear protective clothing	1 / Pack
Class B Photoluminescent Polypropylene					
835665	250	100	Class B	Wear protective clothing	1 / Pack

Complies with EN ISO 7010

MO11 : WASH YOUR HANDS

Washing hands is one of the most effective ways to prevent the spread of many types of infection and illness in all workplaces.



SIGNS

Order Ref.	Diameter (mm)	Total Qty/Pack
Laminated Polyester		
819461	50	2 / Pack
819463	100	1 / Pack
819464	200	1 / Pack
819465	315	1 / Pack
Polypropylene		
819467	100	1 / Pack
819468	200	1 / Pack
819469	315	1 / Pack
819470	400	1 / Pack
Aluminium		
819471	100	1 / Pack
819472	200	1 / Pack
819473	315	1 / Pack

FLOOR MARKING

Order Ref.	Diameter (mm)	Total Qty/Pack
Anti-skid Laminated Polyester		
819466	500	1 / Pack

MINI-PICTOGRAMS

Order Ref.	Diameter (mm)	Total Qty/Pack
Laminated Polyester		
819459	25	7 / Pack
Vinyl		
819457	15	54 / Pack



PICTOGRAMS ON ROLLS

Order Ref.	Diameter (mm)	Total Qty/Pack
Laminated Polyester		
819458	25	250 / Roll
819460	50	250 / Roll
819462	100	250 / Roll

SIGNS WITH TEXT



Order Ref.	Width (mm)	Height (mm)	Layout	Legend	Total Qty/Pack
Polypropylene					
819529	150	50	Landscape	Wash your hands	1 / Pack
819530	297	74	Landscape	Wash your hands	1 / Pack
819531	297	105	Landscape	Wash your hands	1 / Pack
819532	450	150	Landscape	Wash your hands	1 / Pack
819533	600	200	Landscape	Wash your hands	1 / Pack
819526	148	210	Portrait	Wash your hands	1 / Pack
819527	210	297	Portrait	Wash your hands	1 / Pack
819528	297	420	Portrait	Wash your hands	1 / Pack
Aluminium					
819537	150	50	Landscape	Wash your hands	1 / Pack
819538	297	105	Landscape	Wash your hands	1 / Pack
819539	450	150	Landscape	Wash your hands	1 / Pack
819534	148	210	Portrait	Wash your hands	1 / Pack
819535	210	297	Portrait	Wash your hands	1 / Pack
819536	297	420	Portrait	Wash your hands	1 / Pack
Laminated Polyester					
819521	150	50	Landscape	Wash your hands	1 / Pack
819522	297	74	Landscape	Wash your hands	1 / Pack
819523	297	105	Landscape	Wash your hands	1 / Pack
819524	450	150	Landscape	Wash your hands	1 / Pack
819525	600	200	Landscape	Wash your hands	1 / Pack
819518	148	210	Portrait	Wash your hands	1 / Pack
819519	210	297	Portrait	Wash your hands	1 / Pack
819520	297	420	Portrait	Wash your hands	1 / Pack



PHOTOLUMINESCENT SIGNS

Order Ref.	Diameter (mm)	Class	Total Qty/Pack
Class B Photoluminescent Polyester			
835675	150	Class B	1 / Pack
Class C Photoluminescent Polyester			
835678	150	Class C	1 / Pack
Class B Photoluminescent Polypropylene			
835673	150	Class B	1 / Pack
Class C Photoluminescent Polypropylene			
835674	150	Class C	1 / Pack
Class C Photoluminescent Aluminium			
835672	150	Class C	1 / Pack

i For all material properties and applications, see pages 4-5

BRADY Customise-it See page 196 to order your custom-made signs.



M012 : USE HANDRAIL

It is easy to fall downstairs. Use the handrail to prevent falling or make it possible to minimise the consequences.



SIGNS

Order Ref.	Diameter (mm)	Total Qty/Pack
Laminated Polyester		
819610	50	2 / Pack
819612	100	1 / Pack
819613	200	1 / Pack
819614	315	1 / Pack
Polypropylene		
819616	100	1 / Pack
819617	200	1 / Pack
819618	315	1 / Pack
819619	400	1 / Pack
Aluminium		
819620	100	1 / Pack
819621	200	1 / Pack
819622	315	1 / Pack

FLOOR MARKING

Order Ref.	Diameter (mm)	Total Qty/Pack
Anti-skid Laminated Polyester		
819615	500	1 / Pack

MINI-PICTOGRAMS

Order Ref.	Diameter (mm)	Total Qty/Pack
Laminated Polyester		
819608	25	7 / Pack
Vinyl		
819606	15	54 / Pack

SIGNS WITH TEXT



Order Ref.	Width (mm)	Height (mm)	Layout	Legend	Total Qty/Pack
Polypropylene					
819678	150	50	Landscape	Use handrail	1 / Pack
819679	297	74	Landscape	Use handrail	1 / Pack
819680	297	105	Landscape	Use handrail	1 / Pack
819681	450	150	Landscape	Use handrail	1 / Pack
819682	600	200	Landscape	Use handrail	1 / Pack
819675	148	210	Portrait	Use handrail	1 / Pack
819676	210	297	Portrait	Use handrail	1 / Pack
819677	297	420	Portrait	Use handrail	1 / Pack
Aluminium					
819686	150	50	Landscape	Use handrail	1 / Pack
819687	297	105	Landscape	Use handrail	1 / Pack
819688	450	150	Landscape	Use handrail	1 / Pack
819683	148	210	Portrait	Use handrail	1 / Pack
819684	210	297	Portrait	Use handrail	1 / Pack
819685	297	420	Portrait	Use handrail	1 / Pack
Laminated Polyester					
819670	150	50	Landscape	Use handrail	1 / Pack
819671	297	74	Landscape	Use handrail	1 / Pack
819672	297	105	Landscape	Use handrail	1 / Pack
819673	450	150	Landscape	Use handrail	1 / Pack
819674	600	200	Landscape	Use handrail	1 / Pack
819667	148	210	Portrait	Use handrail	1 / Pack
819668	210	297	Portrait	Use handrail	1 / Pack
819669	297	420	Portrait	Use handrail	1 / Pack



PICTOGRAMS ON ROLLS

Order Ref.	Diameter (mm)	Total Qty/Pack
Laminated Polyester		
819607	25	250 / Roll
819609	50	250 / Roll
819611	100	250 / Roll



PHOTOLUMINESCENT SIGNS

Order Ref.	Diameter (mm)	Class	Total Qty/Pack
Class B Photoluminescent Polyester			
835682	150	Class B	1 / Pack
Class C Photoluminescent Polyester			
835683	150	Class C	1 / Pack
Class B Photoluminescent Polypropylene			
835680	150	Class B	1 / Pack
Class C Photoluminescent Polypropylene			
835681	150	Class C	1 / Pack
Class C Photoluminescent Aluminium			
835679	150	Class C	1 / Pack

i For all material properties and applications, see pages 4-5

BRADY Customise-it See page 196 to order your custom-made signs.

Complies with EN ISO 7010

M013 : WEAR FACE SHIELD

For work areas where there is a risk of flying objects or particles, a protective visor covering the entire face is essential.



SIGNS

Order Ref.	Diameter (mm)	Total Qty/Pack
Laminated Polyester		
819759	50	2 / Pack
819761	100	1 / Pack
819762	200	1 / Pack
819763	315	1 / Pack
Polypropylene		
819765	100	1 / Pack
819766	200	1 / Pack
819767	315	1 / Pack
819768	400	1 / Pack
Aluminium		
819769	100	1 / Pack
819770	200	1 / Pack
819771	315	1 / Pack

FLOOR MARKING

Order Ref.	Diameter (mm)	Total Qty/Pack
Anti-skid Laminated Polyester		
819764	500	1 / Pack

MINI-PICTOGRAMS

Order Ref.	Diameter (mm)	Total Qty/Pack
Laminated Polyester		
819757	25	7 / Pack
Vinyl		
819755	15	54 / Pack

SIGNS WITH TEXT



Order Ref.	Width (mm)	Height (mm)	Layout	Legend	Total Qty/Pack
Polypropylene					
819827	150	50	Landscape	Wear face shield	1 / Pack
819828	297	74	Landscape	Wear face shield	1 / Pack
819829	297	105	Landscape	Wear face shield	1 / Pack
819830	450	150	Landscape	Wear face shield	1 / Pack
819831	600	200	Landscape	Wear face shield	1 / Pack
819824	148	210	Portrait	Wear face shield	1 / Pack
819825	210	297	Portrait	Wear face shield	1 / Pack
819826	297	420	Portrait	Wear face shield	1 / Pack
Aluminium					
819835	150	50	Landscape	Wear face shield	1 / Pack
819836	297	105	Landscape	Wear face shield	1 / Pack
819837	450	150	Landscape	Wear face shield	1 / Pack
819832	148	210	Portrait	Wear face shield	1 / Pack
819833	210	297	Portrait	Wear face shield	1 / Pack
819834	297	420	Portrait	Wear face shield	1 / Pack
Laminated Polyester					
819819	150	50	Landscape	Wear face shield	1 / Pack
819820	297	74	Landscape	Wear face shield	1 / Pack
819821	297	105	Landscape	Wear face shield	1 / Pack
819822	450	150	Landscape	Wear face shield	1 / Pack
819823	600	200	Landscape	Wear face shield	1 / Pack
819816	148	210	Portrait	Wear face shield	1 / Pack
819817	210	297	Portrait	Wear face shield	1 / Pack
819818	297	420	Portrait	Wear face shield	1 / Pack



PICTOGRAMS ON ROLLS

Order Ref.	Diameter (mm)	Total Qty/Pack
Laminated Polyester		
819756	25	250 / Roll
819758	50	250 / Roll
819760	100	250 / Roll



PHOTOLUMINESCENT SIGNS

Order Ref.	Diameter (mm)	Class	Total Qty/Pack
Class B Photoluminescent Polyester			
835687	150	Class B	1 / Pack
Class C Photoluminescent Polyester			
835688	150	Class C	1 / Pack
Class B Photoluminescent Polypropylene			
835685	150	Class B	1 / Pack
Class C Photoluminescent Polypropylene			
835686	150	Class C	1 / Pack
Class C Photoluminescent Aluminium			
835684	150	Class C	1 / Pack

i For all material properties and applications, see pages 4-5

BRADY Customise-it See page 196 to order your custom-made signs.



M014 : WEAR HEAD PROTECTION

Where a worker could be hit on the head by falling or projecting objects, wearing head protection will be required. Wearing a helmet or even a cap, provided it has a hard shell.



SIGNS

Order Ref.	Diameter (mm)	Total Qty/Pack
Laminated Polyester		
819908	50	2 / Pack
819910	100	1 / Pack
819911	200	1 / Pack
819912	315	1 / Pack
Polypropylene		
819914	100	1 / Pack
819915	200	1 / Pack
819916	315	1 / Pack
819917	400	1 / Pack
Aluminium		
819918	100	1 / Pack
819919	200	1 / Pack
819920	315	1 / Pack

FLOOR MARKING

Order Ref.	Diameter (mm)	Total Qty/Pack
Anti-skid Laminated Polyester		
819913	500	1 / Pack

MINI-PICTOGRAMS

Order Ref.	Diameter (mm)	Total Qty/Pack
Laminated Polyester		
138969	24	18 / Pack
819906	25	7 / Pack
Vinyl		
819904	15	54 / Pack



PICTOGRAMS ON ROLLS

Order Ref.	Diameter (mm)	Total Qty/Pack
Laminated Polyester		
819905	25	250 / Roll
819907	50	250 / Roll
819909	100	250 / Roll



PHOTOLUMINESCENT SIGNS

Order Ref.	Diameter (mm)	Class	Total Qty/Pack
Class B Photoluminescent Polyester			
836749	150	Class B	1 / Pack
836750	200	Class B	1 / Pack

SIGNS WITH TEXT



Order Ref.	Width (mm)	Height (mm)	Layout	Legend	Total Qty/Pack
Polypropylene					
819976	150	50	Landscape	Wear head protection	1 / Pack
819977	297	74	Landscape	Wear head protection	1 / Pack
819978	297	105	Landscape	Wear head protection	1 / Pack
819979	450	150	Landscape	Wear head protection	1 / Pack
819980	600	200	Landscape	Wear head protection	1 / Pack
819973	148	210	Portrait	Wear head protection	1 / Pack
819974	210	297	Portrait	Wear head protection	1 / Pack
819975	297	420	Portrait	Wear head protection	1 / Pack
Aluminium					
819984	150	50	Landscape	Wear head protection	1 / Pack
819985	297	105	Landscape	Wear head protection	1 / Pack
819986	450	150	Landscape	Wear head protection	1 / Pack
819981	148	210	Portrait	Wear head protection	1 / Pack
819982	210	297	Portrait	Wear head protection	1 / Pack
819983	297	420	Portrait	Wear head protection	1 / Pack
Laminated Polyester					
819968	150	50	Landscape	Wear head protection	1 / Pack
819969	297	74	Landscape	Wear head protection	1 / Pack
819970	297	105	Landscape	Wear head protection	1 / Pack
819971	450	150	Landscape	Wear head protection	1 / Pack
819972	600	200	Landscape	Wear head protection	1 / Pack
819965	148	210	Portrait	Wear head protection	1 / Pack
819966	210	297	Portrait	Wear head protection	1 / Pack
819967	297	420	Portrait	Wear head protection	1 / Pack

PHOTOLUMINESCENT SIGNS WITH TEXT



Order Ref.	Width (mm)	Height (mm)	Class	Legend	Total Qty/Pack
Class B Photoluminescent Polyester					
835690	300	400	Class B	Safety helmets must be worn in this area at all times	1 / Pack
Class B Photoluminescent Polypropylene					
835689	300	400	Class B	Safety helmets must be worn in this area at all times	1 / Pack

i For all material properties and applications, see pages 4-5

BRADY Customise-it See page 196 to order your custom-made signs.

Complies with EN ISO 7010

M015 : WEAR HIGH VISIBILITY CLOTHING

Wearing a safety vest, generally yellow or orange, increases worker visibility. In a situation with a lot of movement, of people or machines, such increased visibility improves security for everyone.



SIGNS

Order Ref.	Diameter (mm)	Total Qty/Pack
Laminated Polyester		
820057	50	2 / Pack
820059	100	1 / Pack
820060	200	1 / Pack
820061	315	1 / Pack
Polypropylene		
820063	100	1 / Pack
820064	200	1 / Pack
820065	315	1 / Pack
820066	400	1 / Pack
Aluminium		
820067	100	1 / Pack
820068	200	1 / Pack
820069	315	1 / Pack

FLOOR MARKING

Order Ref.	Diameter (mm)	Total Qty/Pack
Anti-skid Laminated Polyester		
820062	500	1 / Pack

MINI-PICTOGRAMS

Order Ref.	Diameter (mm)	Total Qty/Pack
Laminated Polyester		
820055	25	7 / Pack
Vinyl		
820053	15	54 / Pack



PICTOGRAMS ON ROLLS

Order Ref.	Diameter (mm)	Total Qty/Pack
Laminated Polyester		
820054	25	250 / Roll
820056	50	250 / Roll
820058	100	250 / Roll



PHOTOLUMINESCENT SIGNS

Order Ref.	Diameter (mm)	Class	Total Qty/Pack
Class B Photoluminescent Polyester			
835696	150	Class B	1 / Pack
Class C Photoluminescent Polyester			
835698	150	Class C	1 / Pack
Class B Photoluminescent Polypropylene			
835694	150	Class B	1 / Pack
Class C Photoluminescent Polypropylene			
835695	150	Class C	1 / Pack
Class C Photoluminescent Aluminium			
835693	150	Class C	1 / Pack

SIGNS WITH TEXT



Order Ref.	Width (mm)	Height (mm)	Layout	Legend	Total Qty/Pack
Polypropylene					
820125	150	50	Landscape	Wear high visibility clothing	1 / Pack
820126	297	74	Landscape	Wear high visibility clothing	1 / Pack
820127	297	105	Landscape	Wear high visibility clothing	1 / Pack
820128	450	150	Landscape	Wear high visibility clothing	1 / Pack
820129	600	200	Landscape	Wear high visibility clothing	1 / Pack
820122	148	210	Portrait	Wear high visibility clothing	1 / Pack
820123	210	297	Portrait	Wear high visibility clothing	1 / Pack
820124	297	420	Portrait	Wear high visibility clothing	1 / Pack
Aluminium					
820133	150	50	Landscape	Wear high visibility clothing	1 / Pack
820134	297	105	Landscape	Wear high visibility clothing	1 / Pack
820135	450	150	Landscape	Wear high visibility clothing	1 / Pack
820130	148	210	Portrait	Wear high visibility clothing	1 / Pack
820131	210	297	Portrait	Wear high visibility clothing	1 / Pack
820132	297	420	Portrait	Wear high visibility clothing	1 / Pack
Laminated Polyester					
820117	150	50	Landscape	Wear high visibility clothing	1 / Pack
820118	297	74	Landscape	Wear high visibility clothing	1 / Pack
820119	297	105	Landscape	Wear high visibility clothing	1 / Pack
820120	450	150	Landscape	Wear high visibility clothing	1 / Pack
820121	600	200	Landscape	Wear high visibility clothing	1 / Pack
820114	148	210	Portrait	Wear high visibility clothing	1 / Pack
820115	210	297	Portrait	Wear high visibility clothing	1 / Pack
820116	297	420	Portrait	Wear high visibility clothing	1 / Pack

PHOTOLUMINESCENT SIGNS WITH TEXT



Order Ref.	Width (mm)	Height (mm)	Class	Legend	Total Qty/Pack
Class B Photoluminescent Polyester					
835692	300	400	Class B	High visibility clothing must be worn in this area	1 / Pack
Class B Photoluminescent Polypropylene					
835691	300	400	Class B	High visibility clothing must be worn in this area	1 / Pack

i For all material properties and applications, see pages 4-5

BRADY Customise-it See page 196 to order your custom-made signs.



M016 : WEAR A MASK

To prevent the release of and contamination by certain particles, wearing a mask is sometimes obligatory.



SIGNS

Order Ref.	Diameter (mm)	Total Qty/Pack
Laminated Polyester		
820206	50	2 / Pack
820208	100	1 / Pack
820209	200	1 / Pack
820210	315	1 / Pack
Polypropylene		
820212	100	1 / Pack
820213	200	1 / Pack
820214	315	1 / Pack
820215	400	1 / Pack
Aluminium		
820216	100	1 / Pack
820217	200	1 / Pack
820218	315	1 / Pack

FLOOR MARKING

Order Ref.	Diameter (mm)	Total Qty/Pack
Anti-skid Laminated Polyester		
820211	500	1 / Pack

MINI-PICTOGRAMS

Order Ref.	Diameter (mm)	Total Qty/Pack
Laminated Polyester		
820204	25	7 / Pack
Vinyl		
820202	15	54 / Pack

SIGNS WITH TEXT



Order Ref.	Width (mm)	Height (mm)	Layout	Legend	Total Qty/Pack
Polypropylene					
820274	150	50	Landscape	Wear a mask	1 / Pack
820275	297	74	Landscape	Wear a mask	1 / Pack
820276	297	105	Landscape	Wear a mask	1 / Pack
820277	450	150	Landscape	Wear a mask	1 / Pack
820278	600	200	Landscape	Wear a mask	1 / Pack
820271	148	210	Portrait	Wear a mask	1 / Pack
820272	210	297	Portrait	Wear a mask	1 / Pack
820273	297	420	Portrait	Wear a mask	1 / Pack
Aluminium					
820282	150	50	Landscape	Wear a mask	1 / Pack
820283	297	105	Landscape	Wear a mask	1 / Pack
820284	450	150	Landscape	Wear a mask	1 / Pack
820279	148	210	Portrait	Wear a mask	1 / Pack
820280	210	297	Portrait	Wear a mask	1 / Pack
820281	297	420	Portrait	Wear a mask	1 / Pack
Laminated Polyester					
820266	150	50	Landscape	Wear a mask	1 / Pack
820267	297	74	Landscape	Wear a mask	1 / Pack
820268	297	105	Landscape	Wear a mask	1 / Pack
820269	450	150	Landscape	Wear a mask	1 / Pack
820270	600	200	Landscape	Wear a mask	1 / Pack
820263	148	210	Portrait	Wear a mask	1 / Pack
820264	210	297	Portrait	Wear a mask	1 / Pack
820265	297	420	Portrait	Wear a mask	1 / Pack



PICTOGRAMS ON ROLLS

Order Ref.	Diameter (mm)	Total Qty/Pack
Laminated Polyester		
820203	25	250 / Roll
820205	50	250 / Roll
820207	100	250 / Roll



PHOTOLUMINESCENT SIGNS

Order Ref.	Diameter (mm)	Class	Total Qty/Pack
Class B Photoluminescent Polyester			
835705	150	Class B	1 / Pack
Class C Photoluminescent Polyester			
835706	150	Class C	1 / Pack
Class B Photoluminescent Polypropylene			
835703	150	Class B	1 / Pack
Class C Photoluminescent Polypropylene			
835704	150	Class C	1 / Pack
Class C Photoluminescent Aluminium			
835699	150	Class C	1 / Pack

i For all material properties and applications, see pages 4-5

BRADY Customise-it See page 196 to order your custom-made signs.

Complies with EN ISO 7010

M017 : WEAR RESPIRATORY PROTECTION

In the presence of fine particles which are a health hazard, a filter mask or any other means of protecting the respiratory tract may be compulsory.



SIGNS

Order Ref.	Diameter (mm)	Total Qty/Pack
Laminated Polyester		
820355	50	2 / Pack
820357	100	1 / Pack
820358	200	1 / Pack
820359	315	1 / Pack
Polypropylene		
820361	100	1 / Pack
820362	200	1 / Pack
820363	315	1 / Pack
820364	400	1 / Pack
Aluminium		
820365	100	1 / Pack
820366	200	1 / Pack
820367	315	1 / Pack

FLOOR MARKING

Order Ref.	Diameter (mm)	Total Qty/Pack
Anti-skid Laminated Polyester		
820360	500	1 / Pack

MINI-PICTOGRAMS

Order Ref.	Diameter (mm)	Total Qty/Pack
Laminated Polyester		
139140	24	18 / Pack
820353	25	7 / Pack
138989	30	15 / Pack
Vinyl		
820351	15	54 / Pack



PICTOGRAMS ON ROLLS

Order Ref.	Diameter (mm)	Total Qty/Pack
Laminated Polyester		
820352	25	250 / Roll
820354	50	250 / Roll
820356	100	250 / Roll



PHOTOLUMINESCENT SIGNS

Order Ref.	Diameter (mm)	Class	Total Qty/Pack
Class B Photoluminescent Polyester			
835736	150	Class B	1 / Pack
Class C Photoluminescent Polyester			
835737	150	Class C	1 / Pack
Class B Photoluminescent Polypropylene			
835724	150	Class B	1 / Pack
Class C Photoluminescent Polypropylene			
835734	150	Class C	1 / Pack
Class C Photoluminescent Aluminium			
835723	150	Class C	1 / Pack

SIGNS WITH TEXT



Order Ref.	Width (mm)	Height (mm)	Layout	Legend	Total Qty/Pack
Polypropylene					
820423	150	50	Landscape	Wear respiratory protection	1 / Pack
820424	297	74	Landscape	Wear respiratory protection	1 / Pack
820425	297	105	Landscape	Wear respiratory protection	1 / Pack
820426	450	150	Landscape	Wear respiratory protection	1 / Pack
820427	600	200	Landscape	Wear respiratory protection	1 / Pack
820420	148	210	Portrait	Wear respiratory protection	1 / Pack
820421	210	297	Portrait	Wear respiratory protection	1 / Pack
820422	297	420	Portrait	Wear respiratory protection	1 / Pack
Aluminium					
820431	150	50	Landscape	Wear respiratory protection	1 / Pack
820432	297	105	Landscape	Wear respiratory protection	1 / Pack
820433	450	150	Landscape	Wear respiratory protection	1 / Pack
820428	148	210	Portrait	Wear respiratory protection	1 / Pack
820280	210	297	Portrait	Wear a mask	1 / Pack
820429	210	297	Portrait	Wear respiratory protection	1 / Pack
820430	297	420	Portrait	Wear respiratory protection	1 / Pack
Laminated Polyester					
820415	150	50	Landscape	Wear respiratory protection	1 / Pack
820416	297	74	Landscape	Wear respiratory protection	1 / Pack
820417	297	105	Landscape	Wear respiratory protection	1 / Pack
820418	450	150	Landscape	Wear respiratory protection	1 / Pack
820419	600	200	Landscape	Wear respiratory protection	1 / Pack
820413	210	297	Portrait	Wear respiratory protection	1 / Pack
820414	297	420	Portrait	Wear respiratory protection	1 / Pack

PHOTOLUMINESCENT SIGNS WITH TEXT



Order Ref.	Width (mm)	Height (mm)	Class	Legend	Total Qty/Pack
Class B Photoluminescent Polyester					
835713	250	100	Class B	Respirators must be worn in this area	1 / Pack
835718	300	400	Class B	Respirators must be worn in this area	1 / Pack
Class B Photoluminescent Polypropylene					
835707	250	100	Class B	Respirators must be worn in this area	1 / Pack
835708	300	400	Class B	Respirators must be worn in this area	1 / Pack

i For all material properties and applications, see pages 4-5

BRADY Customise-it See page 196 to order your custom-made signs.



M018 : WEAR SAFETY HARNESS

In the event of working at heights, a safety harness may be required to prevent falling and a range of risks.



SIGNS

Order Ref.	Diameter (mm)	Total Qty/Pack
Laminated Polyester		
820504	50	2 / Pack
820506	100	1 / Pack
820507	200	1 / Pack
820508	315	1 / Pack
Polypropylene		
820510	100	1 / Pack
820511	200	1 / Pack
820512	315	1 / Pack
820513	400	1 / Pack
Aluminium		
820514	100	1 / Pack
820515	200	1 / Pack
820516	315	1 / Pack

FLOOR MARKING

Order Ref.	Diameter (mm)	Total Qty/Pack
Anti-skid Laminated Polyester		
820509	500	1 / Pack

MINI-PICTOGRAMS

Order Ref.	Diameter (mm)	Total Qty/Pack
Laminated Polyester		
820502	25	7 / Pack
138992	50	6 / Pack
Vinyl		
820500	15	54 / Pack

SIGNS WITH TEXT



Order Ref.	Width (mm)	Height (mm)	Layout	Legend	Total Qty/Pack
Polypropylene					
820569	148	210	Portrait	Wear safety harness	1 / Pack
820570	210	297	Portrait	Wear safety harness	1 / Pack
Aluminium					
820580	150	50	Landscape	Wear safety harness	1 / Pack
820581	297	105	Landscape	Wear safety harness	1 / Pack
820582	450	150	Landscape	Wear safety harness	1 / Pack
Laminated Polyester					
820564	150	50	Landscape	Wear safety harness	1 / Pack
820565	297	74	Landscape	Wear safety harness	1 / Pack
820566	297	105	Landscape	Wear safety harness	1 / Pack
820567	450	150	Landscape	Wear safety harness	1 / Pack
820568	600	200	Landscape	Wear safety harness	1 / Pack
820561	148	210	Portrait	Wear safety harness	1 / Pack
820562	210	297	Portrait	Wear safety harness	1 / Pack
820563	297	420	Portrait	Wear safety harness	1 / Pack



PICTOGRAMS ON ROLLS

Order Ref.	Diameter (mm)	Total Qty/Pack
Laminated Polyester		
820501	25	250 / Roll
820503	50	250 / Roll
820505	100	250 / Roll



PHOTOLUMINESCENT SIGNS

Order Ref.	Diameter (mm)	Class	Total Qty/Pack
Class B Photoluminescent Polyester			
835745	150	Class B	1 / Pack
Class C Photoluminescent Polyester			
835748	150	Class C	1 / Pack
Class B Photoluminescent Polypropylene			
835740	150	Class B	1 / Pack
Class C Photoluminescent Polypropylene			
835741	150	Class C	1 / Pack
Class C Photoluminescent Aluminium			
835739	150	Class C	1 / Pack

i For all material properties and applications, see pages 4-5

BRADY Customise-it See page 196 to order your custom-made signs.

Complies with EN ISO 7010

M019 : WEAR WELDING MASK

Welding generates hot flying particles, intense light and UV radiation which can injure the whole face. To protect the face of the welder, and above all their eyesight, the appropriate mask is required.



SIGNS

Order Ref.	Diameter (mm)	Total Qty/Pack
Laminated Polyester		
820653	50	2 / Pack
820655	100	1 / Pack
820656	200	1 / Pack
820657	315	1 / Pack
Polypropylene		
820659	100	1 / Pack
820660	200	1 / Pack
820661	315	1 / Pack
820662	400	1 / Pack
Aluminium		
820663	100	1 / Pack
820664	200	1 / Pack
820665	315	1 / Pack

FLOOR MARKING

Order Ref.	Diameter (mm)	Total Qty/Pack
Anti-skid Laminated Polyester		
820658	500	1 / Pack

MINI-PICTOGRAMS

Order Ref.	Diameter (mm)	Total Qty/Pack
Laminated Polyester		
820651	25	7 / Pack
Vinyl		
820649	15	54 / Pack

SIGNS WITH TEXT



Order Ref.	Width (mm)	Height (mm)	Layout	Legend	Total Qty/Pack
Polypropylene					
820721	150	50	Landscape	Wear welding mask	1 / Pack
820722	297	74	Landscape	Wear welding mask	1 / Pack
820723	297	105	Landscape	Wear welding mask	1 / Pack
820724	450	150	Landscape	Wear welding mask	1 / Pack
820725	600	200	Landscape	Wear welding mask	1 / Pack
820718	148	210	Portrait	Wear welding mask	1 / Pack
820719	210	297	Portrait	Wear welding mask	1 / Pack
820720	297	420	Portrait	Wear welding mask	1 / Pack
Aluminium					
820729	150	50	Landscape	Wear welding mask	1 / Pack
820730	297	105	Landscape	Wear welding mask	1 / Pack
820731	450	150	Landscape	Wear welding mask	1 / Pack
820726	148	210	Portrait	Wear welding mask	1 / Pack
820727	210	297	Portrait	Wear welding mask	1 / Pack
820728	297	420	Portrait	Wear welding mask	1 / Pack
Laminated Polyester					
820713	150	50	Landscape	Wear welding mask	1 / Pack
820714	297	74	Landscape	Wear welding mask	1 / Pack
820715	297	105	Landscape	Wear welding mask	1 / Pack
820716	450	150	Landscape	Wear welding mask	1 / Pack
820717	600	200	Landscape	Wear welding mask	1 / Pack
820710	148	210	Portrait	Wear welding mask	1 / Pack
820711	210	297	Portrait	Wear welding mask	1 / Pack
820712	297	420	Portrait	Wear welding mask	1 / Pack



PICTOGRAMS ON ROLLS

Order Ref.	Diameter (mm)	Total Qty/Pack
Laminated Polyester		
820650	25	250 / Roll
820652	50	250 / Roll
820654	100	250 / Roll



PHOTOLUMINESCENT SIGNS

Order Ref.	Diameter (mm)	Class	Total Qty/Pack
Class B Photoluminescent Polyester			
835756	150	Class B	1 / Pack
Class C Photoluminescent Polyester			
835758	150	Class C	1 / Pack
Class B Photoluminescent Polypropylene			
835750	150	Class B	1 / Pack
Class C Photoluminescent Polypropylene			
835752	150	Class C	1 / Pack
Class C Photoluminescent Aluminium			
835749	150	Class C	1 / Pack

i For all material properties and applications, see pages 4-5

BRADY Customise-it See page 196 to order your custom-made signs.

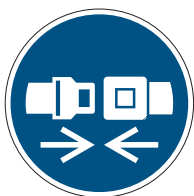

M020 : WEAR SAFETY BELTS

Wearing a seat belt is obligatory in cars, trucks, forklifts and buses. This symbol indicates this for all users.



SIGNS

Order Ref.	Diameter (mm)	Total Qty/Pack
Laminated Polyester		
820802	50	2 / Pack
820804	100	1 / Pack
820805	200	1 / Pack
820806	315	1 / Pack
Polypropylene		
820808	100	1 / Pack
820809	200	1 / Pack
820810	315	1 / Pack
820811	400	1 / Pack
Aluminium		
820812	100	1 / Pack
820813	200	1 / Pack
820814	315	1 / Pack

MINI-PICTOGRAMS

Order Ref.	Diameter (mm)	Total Qty/Pack
Laminated Polyester		
820800	25	7 / Pack
Vinyl		
820798	15	54 / Pack

SIGNS WITH TEXT



Order Ref.	Width (mm)	Height (mm)	Layout	Legend	Total Qty/Pack
Polypropylene					
820870	150	50	Landscape	Wear safety belts	1 / Pack
820871	297	74	Landscape	Wear safety belts	1 / Pack
820872	297	105	Landscape	Wear safety belts	1 / Pack
820873	450	150	Landscape	Wear safety belts	1 / Pack
820874	600	200	Landscape	Wear safety belts	1 / Pack
820867	148	210	Portrait	Wear safety belts	1 / Pack
820868	210	297	Portrait	Wear safety belts	1 / Pack
820869	297	420	Portrait	Wear safety belts	1 / Pack
Aluminium					
820878	150	50	Landscape	Wear safety belts	1 / Pack
820879	297	105	Landscape	Wear safety belts	1 / Pack
820880	450	150	Landscape	Wear safety belts	1 / Pack
820875	148	210	Portrait	Wear safety belts	1 / Pack
820876	210	297	Portrait	Wear safety belts	1 / Pack
820877	297	420	Portrait	Wear safety belts	1 / Pack
Laminated Polyester					
820862	150	50	Landscape	Wear safety belts	1 / Pack
820863	297	74	Landscape	Wear safety belts	1 / Pack
820864	297	105	Landscape	Wear safety belts	1 / Pack
820865	450	150	Landscape	Wear safety belts	1 / Pack
820866	600	200	Landscape	Wear safety belts	1 / Pack
820859	148	210	Portrait	Wear safety belts	1 / Pack
820860	210	297	Portrait	Wear safety belts	1 / Pack
820861	297	420	Portrait	Wear safety belts	1 / Pack



PICTOGRAMS ON ROLLS

Order Ref.	Diameter (mm)	Total Qty/Pack
Laminated Polyester		
820799	25	250 / Roll
820801	50	250 / Roll
820803	100	250 / Roll



PHOTOLUMINESCENT SIGNS

Order Ref.	Diameter (mm)	Class	Total Qty/Pack
Class B Photoluminescent Polyester			
835763	150	Class B	1 / Pack
Class C Photoluminescent Polyester			
835764	150	Class C	1 / Pack
Class B Photoluminescent Polypropylene			
835760	150	Class B	1 / Pack
Class C Photoluminescent Polypropylene			
835761	150	Class C	1 / Pack
Class C Photoluminescent Aluminium			
835759	150	Class C	1 / Pack

i For all material properties and applications, see pages 4-5

BRADY Customise-it See page 196 to order your custom-made signs.

Complies with EN ISO 7010

M021 : DISCONNECT BEFORE CARRYING OUT MAINTENANCE OR REPAIR

The maintenance or repair of a machine may prove dangerous. Procedures are widely available to improve how they are carried out. One stage may involve disconnecting the machine under maintenance.



SIGNS

Order Ref.	Diameter (mm)	Total Qty/Pack
Laminated Polyester		
820951	50	2 / Pack
820953	100	1 / Pack
820954	200	1 / Pack
820955	315	1 / Pack
Polypropylene		
820957	100	1 / Pack
820958	200	1 / Pack
820959	315	1 / Pack
820960	400	1 / Pack
Aluminium		
820961	100	1 / Pack
820962	200	1 / Pack
820963	315	1 / Pack

MINI-PICTOGRAMS

Order Ref.	Diameter (mm)	Total Qty/Pack
Laminated Polyester		
820949	25	7 / Pack
138993	50	6 / Pack
Vinyl		
820947	15	54 / Pack



PICTOGRAMS ON ROLLS

Order Ref.	Diameter (mm)	Total Qty/Pack
Laminated Polyester		
820948	25	250 / Roll
820950	50	250 / Roll
820952	100	250 / Roll



PHOTOLUMINESCENT SIGNS

Order Ref.	Diameter (mm)	Class	Total Qty/Pack
Class B Photoluminescent Polyester			
835768	150	Class B	1 / Pack
Class C Photoluminescent Polyester			
835769	150	Class C	1 / Pack
Class B Photoluminescent Polypropylene			
835766	150	Class B	1 / Pack
Class C Photoluminescent Polypropylene			
835767	150	Class C	1 / Pack
Class C Photoluminescent Aluminium			
835765	150	Class C	1 / Pack

SIGNS WITH TEXT



Order Ref.	Width (mm)	Height (mm)	Layout	Legend	Total Qty/Pack
Polypropylene					
821019	150	50	Landscape	Disconnect before carrying out maintenance or repair	1 / Pack
821020	297	74	Landscape	Disconnect before carrying out maintenance or repair	1 / Pack
821021	297	105	Landscape	Disconnect before carrying out maintenance or repair	1 / Pack
821022	450	150	Landscape	Disconnect before carrying out maintenance or repair	1 / Pack
821023	600	200	Landscape	Disconnect before carrying out maintenance or repair	1 / Pack
821016	148	210	Portrait	Disconnect before carrying out maintenance or repair	1 / Pack
821017	210	297	Portrait	Disconnect before carrying out maintenance or repair	1 / Pack
821018	297	420	Portrait	Disconnect before carrying out maintenance or repair	1 / Pack
Aluminium					
821027	150	50	Landscape	Disconnect before carrying out maintenance or repair	1 / Pack
821028	297	105	Landscape	Disconnect before carrying out maintenance or repair	1 / Pack
821029	450	150	Landscape	Disconnect before carrying out maintenance or repair	1 / Pack
821024	148	210	Portrait	Disconnect before carrying out maintenance or repair	1 / Pack
821025	210	297	Portrait	Disconnect before carrying out maintenance or repair	1 / Pack
821026	297	420	Portrait	Disconnect before carrying out maintenance or repair	1 / Pack
Laminated Polyester					
821011	150	50	Landscape	Disconnect before carrying out maintenance or repair	1 / Pack
821012	297	74	Landscape	Disconnect before carrying out maintenance or repair	1 / Pack
821013	297	105	Landscape	Disconnect before carrying out maintenance or repair	1 / Pack
821014	450	150	Landscape	Disconnect before carrying out maintenance or repair	1 / Pack
821015	600	200	Landscape	Disconnect before carrying out maintenance or repair	1 / Pack
821008	148	210	Portrait	Disconnect before carrying out maintenance or repair	1 / Pack
821009	210	297	Portrait	Disconnect before carrying out maintenance or repair	1 / Pack
821010	297	420	Portrait	Disconnect before carrying out maintenance or repair	1 / Pack

i For all material properties and applications, see pages 4-5

BRADY Customise-it See page 196 to order your custom-made signs.



M022 : USE BARRIER CREAM

Certain kinds of handling may require wearing a protective cream beforehand or afterwards.



SIGNS

Order Ref.	Diameter (mm)	Total Qty/Pack
Laminated Polyester		
821100	50	2 / Pack
821102	100	1 / Pack
821103	200	1 / Pack
821104	315	1 / Pack
Polypropylene		
821106	100	1 / Pack
821107	200	1 / Pack
821108	315	1 / Pack
821109	400	1 / Pack
Aluminium		
821110	100	1 / Pack
821111	200	1 / Pack
821112	315	1 / Pack

MINI-PICTOGRAMS

Order Ref.	Diameter (mm)	Total Qty/Pack
Laminated Polyester		
821098	25	7 / Pack
Vinyl		
821096	15	54 / Pack

SIGNS WITH TEXT



Order Ref.	Width (mm)	Height (mm)	Layout	Legend	Total Qty/Pack
Polypropylene					
821168	150	50	Landscape	Use barrier cream	1 / Pack
821169	297	74	Landscape	Use barrier cream	1 / Pack
821170	297	105	Landscape	Use barrier cream	1 / Pack
821171	450	150	Landscape	Use barrier cream	1 / Pack
821172	600	200	Landscape	Use barrier cream	1 / Pack
821165	148	210	Portrait	Use barrier cream	1 / Pack
821166	210	297	Portrait	Use barrier cream	1 / Pack
821167	297	420	Portrait	Use barrier cream	1 / Pack
Aluminium					
821176	150	50	Landscape	Use barrier cream	1 / Pack
821177	297	105	Landscape	Use barrier cream	1 / Pack
821178	450	150	Landscape	Use barrier cream	1 / Pack
821173	148	210	Portrait	Use barrier cream	1 / Pack
821174	210	297	Portrait	Use barrier cream	1 / Pack
821175	297	420	Portrait	Use barrier cream	1 / Pack
Laminated Polyester					
821160	150	50	Landscape	Use barrier cream	1 / Pack
821161	297	74	Landscape	Use barrier cream	1 / Pack
821162	297	105	Landscape	Use barrier cream	1 / Pack
821163	450	150	Landscape	Use barrier cream	1 / Pack
821164	600	200	Landscape	Use barrier cream	1 / Pack
821157	148	210	Portrait	Use barrier cream	1 / Pack
821158	210	297	Portrait	Use barrier cream	1 / Pack
821159	297	420	Portrait	Use barrier cream	1 / Pack



PICTOGRAMS ON ROLLS

Order Ref.	Diameter (mm)	Total Qty/Pack
Laminated Polyester		
821097	25	250 / Roll
821099	50	250 / Roll
821101	100	250 / Roll



PHOTOLUMINESCENT SIGNS

Order Ref.	Diameter (mm)	Class	Total Qty/Pack
Class B Photoluminescent Polyester			
835775	150	Class B	1 / Pack
Class C Photoluminescent Polyester			
835776	150	Class C	1 / Pack
Class B Photoluminescent Polypropylene			
835771	150	Class B	1 / Pack
Class C Photoluminescent Polypropylene			
835772	150	Class C	1 / Pack
Class C Photoluminescent Aluminium			
835770	150	Class C	1 / Pack

i For all material properties and applications, see pages 4-5

BRADY Customise-it See page 196 to order your custom-made signs.

Complies with EN ISO 7010

M023 : USE FOOTBRIDGE

To avoid passing close to the installations on the ground, walkways may be provided for pedestrians. Using them is therefore obligatory for people who do not have to intervene directly on the installations.



SIGNS

Order Ref.	Diameter (mm)	Total Qty/Pack
Laminated Polyester		
821249	50	2 / Pack
821251	100	1 / Pack
821252	200	1 / Pack
821253	315	1 / Pack
Polypropylene		
821255	100	1 / Pack
821256	200	1 / Pack
821257	315	1 / Pack
821258	400	1 / Pack
Aluminium		
821259	100	1 / Pack
821260	200	1 / Pack
821261	315	1 / Pack

FLOOR MARKING

Order Ref.	Diameter (mm)	Total Qty/Pack
Anti-skid Laminated Polyester		
821254	500	1 / Pack

MINI-PICTOGRAMS

Order Ref.	Diameter (mm)	Total Qty/Pack
Laminated Polyester		
821247	25	7 / Pack
Vinyl		
821245	15	54 / Pack

SIGNS WITH TEXT



Order Ref.	Width (mm)	Height (mm)	Layout	Legend	Total Qty/Pack
Polypropylene					
821317	150	50	Landscape	Use footbridge	1 / Pack
821318	297	74	Landscape	Use footbridge	1 / Pack
821319	297	105	Landscape	Use footbridge	1 / Pack
821320	450	150	Landscape	Use footbridge	1 / Pack
821321	600	200	Landscape	Use footbridge	1 / Pack
821314	148	210	Portrait	Use footbridge	1 / Pack
821315	210	297	Portrait	Use footbridge	1 / Pack
821316	297	420	Portrait	Use footbridge	1 / Pack
Aluminium					
821325	150	50	Landscape	Use footbridge	1 / Pack
821326	297	105	Landscape	Use footbridge	1 / Pack
821327	450	150	Landscape	Use footbridge	1 / Pack
821322	148	210	Portrait	Use footbridge	1 / Pack
821323	210	297	Portrait	Use footbridge	1 / Pack
821324	297	420	Portrait	Use footbridge	1 / Pack
Laminated Polyester					
821309	150	50	Landscape	Use footbridge	1 / Pack
821310	297	74	Landscape	Use footbridge	1 / Pack
821311	297	105	Landscape	Use footbridge	1 / Pack
821312	450	150	Landscape	Use footbridge	1 / Pack
821313	600	200	Landscape	Use footbridge	1 / Pack
821306	148	210	Portrait	Use footbridge	1 / Pack
821307	210	297	Portrait	Use footbridge	1 / Pack
821308	297	420	Portrait	Use footbridge	1 / Pack



PICTOGRAMS ON ROLLS

Order Ref.	Diameter (mm)	Total Qty/Pack
Laminated Polyester		
821246	25	250 / Roll
821248	50	250 / Roll
821250	100	250 / Roll



PHOTOLUMINESCENT SIGNS

Order Ref.	Diameter (mm)	Class	Total Qty/Pack
Class B Photoluminescent Polyester			
835786	150	Class B	1 / Pack
Class C Photoluminescent Polyester			
835787	150	Class C	1 / Pack
Class B Photoluminescent Polypropylene			
835782	150	Class B	1 / Pack
Class C Photoluminescent Polypropylene			
835783	150	Class C	1 / Pack
Class C Photoluminescent Aluminium			
835777	150	Class C	1 / Pack

i For all material properties and applications, see pages 4-5

BRADY Customise-it See page 196 to order your custom-made signs.



M024 : USE THIS WALKWAY

To enable people to work in proximity to machines, restricted areas and passages are recommended. The pedestrian area will then be indicated by this sign, and the non-pedestrian by the sign P004. Floor markings restricting these areas will generally complete this signage.



SIGNS

Order Ref.	Diameter (mm)	Total Qty/Pack
Laminated Polyester		
821398	50	2 / Pack
821400	100	1 / Pack
821401	200	1 / Pack
821402	315	1 / Pack
Polypropylene		
821404	100	1 / Pack
821405	200	1 / Pack
821406	315	1 / Pack
821407	400	1 / Pack
Aluminium		
821408	100	1 / Pack
821409	200	1 / Pack
821410	315	1 / Pack

FLOOR MARKING

Order Ref.	Diameter (mm)	Total Qty/Pack
Anti-skid Laminated Polyester		
821403	500	1 / Pack

MINI-PICTOGRAMS

Order Ref.	Diameter (mm)	Total Qty/Pack
Laminated Polyester		
821396	25	7 / Pack
Vinyl		
821394	15	54 / Pack

SIGNS WITH TEXT



Order Ref.	Width (mm)	Height (mm)	Layout	Legend	Total Qty/Pack
Polypropylene					
821466	150	50	Landscape	Use this walkway	1 / Pack
821467	297	74	Landscape	Use this walkway	1 / Pack
821468	297	105	Landscape	Use this walkway	1 / Pack
821469	450	150	Landscape	Use this walkway	1 / Pack
821470	600	200	Landscape	Use this walkway	1 / Pack
821463	148	210	Portrait	Use this walkway	1 / Pack
821464	210	297	Portrait	Use this walkway	1 / Pack
821465	297	420	Portrait	Use this walkway	1 / Pack
Aluminium					
821474	150	50	Landscape	Use this walkway	1 / Pack
821475	297	105	Landscape	Use this walkway	1 / Pack
821476	450	150	Landscape	Use this walkway	1 / Pack
821471	148	210	Portrait	Use this walkway	1 / Pack
821472	210	297	Portrait	Use this walkway	1 / Pack
821473	297	420	Portrait	Use this walkway	1 / Pack
Laminated Polyester					
821458	150	50	Landscape	Use this walkway	1 / Pack
821459	297	74	Landscape	Use this walkway	1 / Pack
821460	297	105	Landscape	Use this walkway	1 / Pack
821461	450	150	Landscape	Use this walkway	1 / Pack
821462	600	200	Landscape	Use this walkway	1 / Pack
821455	148	210	Portrait	Use this walkway	1 / Pack
821456	210	297	Portrait	Use this walkway	1 / Pack
821457	297	420	Portrait	Use this walkway	1 / Pack



PICTOGRAMS ON ROLLS

Order Ref.	Diameter (mm)	Total Qty/Pack
Laminated Polyester		
821395	25	250 / Roll
821397	50	250 / Roll
821399	100	250 / Roll



PHOTOLUMINESCENT SIGNS

Order Ref.	Diameter (mm)	Class	Total Qty/Pack
Class B Photoluminescent Polyester			
835824	150	Class B	1 / Pack
Class C Photoluminescent Polyester			
835825	150	Class C	1 / Pack
Class B Photoluminescent Polypropylene			
835804	150	Class B	1 / Pack
Class C Photoluminescent Polypropylene			
835822	150	Class C	1 / Pack
Class C Photoluminescent Aluminium			
835796	150	Class C	1 / Pack

i For all material properties and applications, see pages 4-5

BRADY Customise-it See page 196 to order your custom-made signs.

i Brady offers a full range of other methods of marking which identify floor areas, stairs, railings and other areas considered as danger zones. Contact your Brady distributor to find out more about our full range of area marking products.



Complies with EN ISO 7010

M025 : INFANTS MUST BE PROTECTED WITH OPAQUE EYE PROTECTION

Children's eyes are more sensitive than those of adults. Infant eyes should be protected before switching on or before placing the infant into any phototherapy equipment.



SIGNS

Order Ref.	Diameter (mm)	Total Qty/Pack
Laminated Polyester		
821547	50	2 / Pack
821549	100	1 / Pack
821550	200	1 / Pack
821551	315	1 / Pack
Polypropylene		
821553	100	1 / Pack
821554	200	1 / Pack
821555	315	1 / Pack
821556	400	1 / Pack
Aluminium		
821557	100	1 / Pack
821558	200	1 / Pack
821559	315	1 / Pack

MINI-PICTOGRAMS

Order Ref.	Diameter (mm)	Total Qty/Pack
Laminated Polyester		
821545	25	7 / Pack
Vinyl		
821543	15	54 / Pack



PICTOGRAMS ON ROLLS

Order Ref.	Diameter (mm)	Total Qty/Pack
Laminated Polyester		
821544	25	250 / Roll
821546	50	250 / Roll
821548	100	250 / Roll



PHOTOLUMINESCENT SIGNS

Order Ref.	Diameter (mm)	Class	Total Qty/Pack
Class B Photoluminescent Polyester			
835832	150	Class B	1 / Pack
Class C Photoluminescent Polyester			
835843	150	Class C	1 / Pack
Class B Photoluminescent Polypropylene			
835829	150	Class B	1 / Pack
Class C Photoluminescent Polypropylene			
835831	150	Class C	1 / Pack
Class C Photoluminescent Aluminium			
835826	150	Class C	1 / Pack

SIGNS WITH TEXT



Order Ref.	Width (mm)	Height (mm)	Layout	Legend	Total Qty/Pack
Polypropylene					
821615	150	50	Landscape	Infants must be protected with opaque eye protection	1 / Pack
821616	297	74	Landscape	Infants must be protected with opaque eye protection	1 / Pack
821617	297	105	Landscape	Infants must be protected with opaque eye protection	1 / Pack
821618	450	150	Landscape	Infants must be protected with opaque eye protection	1 / Pack
821619	600	200	Landscape	Infants must be protected with opaque eye protection	1 / Pack
821612	148	210	Portrait	Infants must be protected with opaque eye protection	1 / Pack
821613	210	297	Portrait	Infants must be protected with opaque eye protection	1 / Pack
821614	297	420	Portrait	Infants must be protected with opaque eye protection	1 / Pack
Aluminium					
821623	150	50	Landscape	Infants must be protected with opaque eye protection	1 / Pack
821624	297	105	Landscape	Infants must be protected with opaque eye protection	1 / Pack
821625	450	150	Landscape	Infants must be protected with opaque eye protection	1 / Pack
821620	148	210	Portrait	Infants must be protected with opaque eye protection	1 / Pack
821621	210	297	Portrait	Infants must be protected with opaque eye protection	1 / Pack
821622	297	420	Portrait	Infants must be protected with opaque eye protection	1 / Pack
Laminated Polyester					
821607	150	50	Landscape	Infants must be protected with opaque eye protection	1 / Pack
821608	297	74	Landscape	Infants must be protected with opaque eye protection	1 / Pack
821609	297	105	Landscape	Infants must be protected with opaque eye protection	1 / Pack
821610	450	150	Landscape	Infants must be protected with opaque eye protection	1 / Pack
821611	600	200	Landscape	Infants must be protected with opaque eye protection	1 / Pack
821604	148	210	Portrait	Infants must be protected with opaque eye protection	1 / Pack
821605	210	297	Portrait	Infants must be protected with opaque eye protection	1 / Pack
821606	297	420	Portrait	Infants must be protected with opaque eye protection	1 / Pack

i For all material properties and applications, see pages 4-5

BRADY Customise-it See page 196 to order your custom-made signs.



M026 : USE PROTECTIVE APRON

Protective aprons may be required to protect workers. In this case it is generally provided by the employer.



SIGNS

Order Ref.	Diameter (mm)	Total Qty/Pack
Laminated Polyester		
821696	50	2 / Pack
821698	100	1 / Pack
821699	200	1 / Pack
821700	315	1 / Pack
Polypropylene		
821702	100	1 / Pack
821703	200	1 / Pack
821704	315	1 / Pack
821705	400	1 / Pack
Aluminium		
821706	100	1 / Pack
821707	200	1 / Pack
821708	315	1 / Pack

FLOOR MARKING

Order Ref.	Diameter (mm)	Total Qty/Pack
Anti-skid Laminated Polyester		
821701	500	1 / Pack

MINI-PICTOGRAMS

Order Ref.	Diameter (mm)	Total Qty/Pack
Laminated Polyester		
821694	25	7 / Pack
Vinyl		
821692	15	54 / Pack

SIGNS WITH TEXT

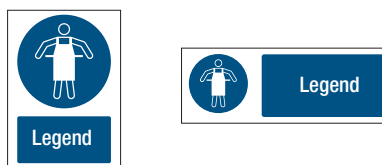

Order Ref.	Width (mm)	Height (mm)	Layout	Legend	Total Qty/Pack
Polypropylene					
821764	150	50	Landscape	Use protective apron	1 / Pack
821765	297	74	Landscape	Use protective apron	1 / Pack
821766	297	105	Landscape	Use protective apron	1 / Pack
821767	450	150	Landscape	Use protective apron	1 / Pack
821768	600	200	Landscape	Use protective apron	1 / Pack
821761	148	210	Portrait	Use protective apron	1 / Pack
821762	210	297	Portrait	Use protective apron	1 / Pack
821763	297	420	Portrait	Use protective apron	1 / Pack
Aluminium					
821772	150	50	Landscape	Use protective apron	1 / Pack
821773	297	105	Landscape	Use protective apron	1 / Pack
821774	450	150	Landscape	Use protective apron	1 / Pack
821769	148	210	Portrait	Use protective apron	1 / Pack
821770	210	297	Portrait	Use protective apron	1 / Pack
821771	297	420	Portrait	Use protective apron	1 / Pack
Laminated Polyester					
821756	150	50	Landscape	Use protective apron	1 / Pack
821757	297	74	Landscape	Use protective apron	1 / Pack
821758	297	105	Landscape	Use protective apron	1 / Pack
821759	450	150	Landscape	Use protective apron	1 / Pack
821760	600	200	Landscape	Use protective apron	1 / Pack
821753	148	210	Portrait	Use protective apron	1 / Pack
821754	210	297	Portrait	Use protective apron	1 / Pack
821755	297	420	Portrait	Use protective apron	1 / Pack



PICTOGRAMS ON ROLLS

Order Ref.	Diameter (mm)	Total Qty/Pack
Laminated Polyester		
821693	25	250 / Roll
821695	50	250 / Roll
821697	100	250 / Roll



PHOTOLUMINESCENT SIGNS

Order Ref.	Diameter (mm)	Class	Total Qty/Pack
Class B Photoluminescent Polyester			
835847	150	Class B	1 / Pack
Class C Photoluminescent Polyester			
835848	150	Class C	1 / Pack
Class B Photoluminescent Polypropylene			
835845	150	Class B	1 / Pack
Class C Photoluminescent Polypropylene			
835846	150	Class C	1 / Pack
Class C Photoluminescent Aluminium			
835844	150	Class C	1 / Pack

i For all material properties and applications, see pages 4-5

BRADY Customise-it See page 196 to order your custom-made signs.

Complies with EN ISO 7010

M027 : CHECK GUARD

Protection is in place to protect machines and users. Ensuring that guards are in place before operating the machinery is essential in preventing injury.



SIGNS

Order Ref.	Diameter (mm)	Total Qty/Pack
Laminated Polyester		
831319	50	2 / Pack
831321	100	1 / Pack
831322	200	1 / Pack
831323	315	1 / Pack
Polypropylene		
831325	100	1 / Pack
831326	200	1 / Pack
831327	315	1 / Pack
831328	400	1 / Pack
Aluminium		
831329	100	1 / Pack
831330	200	1 / Pack
831331	315	1 / Pack

FLOOR MARKING

Order Ref.	Diameter (mm)	Total Qty/Pack
Anti-skid Laminated Polyester		
831324	500	1 / Pack

MINI-PICTOGRAMS

Order Ref.	Diameter (mm)	Total Qty/Pack
Laminated Polyester		
831317	25	7 / Pack
Vinyl		
831315	15	54 / Pack



PHOTOLUMINESCENT SIGNS

Order Ref.	Diameter (mm)	Class	Total Qty/Pack
Class B Photoluminescent Polyester			
835862	150	Class B	1 / Pack
Class C Photoluminescent Polyester			
835863	150	Class C	1 / Pack
Class B Photoluminescent Polypropylene			
835856	150	Class B	1 / Pack
Class C Photoluminescent Polypropylene			
835861	150	Class C	1 / Pack
Class C Photoluminescent Aluminium			
835849	150	Class C	1 / Pack



PICTOGRAMS ON ROLLS

Order Ref.	Diameter (mm)	Total Qty/Pack
Laminated Polyester		
831316	25	250 / Roll
831318	50	250 / Roll
831320	100	250 / Roll

Complies with EN ISO 7010

M028 : KEEP LOCKED

Certain areas, cabinets and machines sometimes need to be locked, especially those that contain harmful substances.



SIGNS

Order Ref.	Diameter (mm)	Total Qty/Pack
Laminated Polyester		
831002	50	2 / Pack
831004	100	1 / Pack
831005	200	1 / Pack
831006	315	1 / Pack
Polypropylene		
831008	100	1 / Pack
831009	200	1 / Pack
831010	315	1 / Pack
Aluminium		
831012	100	1 / Pack
831013	200	1 / Pack
831014	315	1 / Pack

FLOOR MARKING

Order Ref.	Diameter (mm)	Total Qty/Pack
Anti-skid Laminated Polyester		
831007	500	1 / Pack

MINI-PICTOGRAMS

Order Ref.	Diameter (mm)	Total Qty/Pack
Laminated Polyester		
831000	25	7 / Pack
Vinyl		
830998	15	54 / Pack



PHOTOLUMINESCENT SIGNS

Order Ref.	Diameter (mm)	Class	Total Qty/Pack
Class B Photoluminescent Polyester			
835867	150	Class B	1 / Pack
Class C Photoluminescent Polyester			
835868	150	Class C	1 / Pack
Class B Photoluminescent Polypropylene			
835865	150	Class B	1 / Pack
Class C Photoluminescent Polypropylene			
835866	150	Class C	1 / Pack
Class C Photoluminescent Aluminium			
835864	150	Class C	1 / Pack



PICTOGRAMS ON ROLLS

Order Ref.	Diameter (mm)	Total Qty/Pack
Laminated Polyester		
830999	25	250 / Roll
831001	50	250 / Roll
831003	100	250 / Roll



LOCKOUT/TAGOUT SYSTEMS

Contact your Brady distributor to find out more about padlocks and lockout/tagout systems or check out our Lockout / Tagout catalogue.





M029 : SOUND HORN

The horn may be sounded when entering certain areas to clearly indicate when a forklift is present, for example.



SIGNS

Order Ref.	Diameter (mm)	Total Qty/Pack
Laminated Polyester		
831019	50	2 / Pack
831021	100	1 / Pack
831022	200	1 / Pack
831023	315	1 / Pack
Polypropylene		
831025	100	1 / Pack
831026	200	1 / Pack
831027	315	1 / Pack
831028	400	1 / Pack
Aluminium		
831029	100	1 / Pack
831030	200	1 / Pack
831031	315	1 / Pack

MINI-PICTOGRAMS

Order Ref.	Diameter (mm)	Total Qty/Pack
Laminated Polyester		
831017	25	7 / Pack
Vinyl		
831015	15	54 / Pack



PHOTOLUMINESCENT SIGNS

Order Ref.	Diameter (mm)	Class	Total Qty/Pack
Class B Photoluminescent Polyester			
835872	150	Class B	1 / Pack
Class C Photoluminescent Polyester			
835873	150	Class C	1 / Pack
Class B Photoluminescent Polypropylene			
835870	150	Class B	1 / Pack
Class C Photoluminescent Polypropylene			
835871	150	Class C	1 / Pack
Class C Photoluminescent Aluminium			
835869	150	Class C	1 / Pack

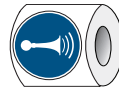

PICTOGRAMS ON ROLLS

Order Ref.	Diameter (mm)	Total Qty/Pack
Laminated Polyester		
831016	25	250 / Roll
831018	50	250 / Roll
831020	100	250 / Roll



M030 : USE LITTER BIN

To keep an area clean, litter must be placed in the litter bin provided. This sign allows us to remind people in a clear, polite fashion.



SIGNS

Order Ref.	Diameter (mm)	Total Qty/Pack
Laminated Polyester		
831036	50	2 / Pack
831038	100	1 / Pack
831039	200	1 / Pack
831040	315	1 / Pack
Polypropylene		
831042	100	1 / Pack
831043	200	1 / Pack
831044	315	1 / Pack
831045	400	1 / Pack
Aluminium		
831046	100	1 / Pack
831047	200	1 / Pack
831048	315	1 / Pack

FLOOR MARKING

Order Ref.	Diameter (mm)	Total Qty/Pack
Anti-skid Laminated Polyester		
831041	500	1 / Pack

MINI-PICTOGRAMS

Order Ref.	Diameter (mm)	Total Qty/Pack
Laminated Polyester		
831034	25	7 / Pack
Vinyl		
831032	15	54 / Pack



PHOTOLUMINESCENT SIGNS

Order Ref.	Diameter (mm)	Class	Total Qty/Pack
Class B Photoluminescent Polyester			
835877	150	Class B	1 / Pack
Class C Photoluminescent Polyester			
835878	150	Class C	1 / Pack
Class B Photoluminescent Polypropylene			
835875	150	Class B	1 / Pack
Class C Photoluminescent Polypropylene			
835876	150	Class C	1 / Pack
Class C Photoluminescent Aluminium			
835874	150	Class C	1 / Pack



PICTOGRAMS ON ROLLS

Order Ref.	Diameter (mm)	Total Qty/Pack
Laminated Polyester		
831033	25	250 / Roll
831035	50	250 / Roll
831037	100	250 / Roll

Complies with EN ISO 7010

M031 : USE TABLE SAW ADJUSTABLE GUARD

To minimise the risks of an accident, bench circular saws have adjustable protection. It is vital to use this and not to leave the saw exposed during use.



SIGNS

Order Ref.	Diameter (mm)	Total Qty/Pack
Laminated Polyester		
831053	50	2 / Pack
831055	100	1 / Pack
831056	200	1 / Pack
831057	315	1 / Pack
Polypropylene		
831059	100	1 / Pack
831060	200	1 / Pack
831061	315	1 / Pack
831062	400	1 / Pack
Aluminium		
831063	100	1 / Pack
831064	200	1 / Pack
831065	315	1 / Pack

FLOOR MARKING

Order Ref.	Diameter (mm)	Total Qty/Pack
Anti-skid Laminated Polyester		
831058	500	1 / Pack

MINI-PICTOGRAMS

Order Ref.	Diameter (mm)	Total Qty/Pack
Laminated Polyester		
831051	25	7 / Pack
Vinyl		
831049	15	54 / Pack



PHOTOLUMINESCENT SIGNS

Order Ref.	Diameter (mm)	Class	Total Qty/Pack
Class B Photoluminescent Polyester			
835882	150	Class B	1 / Pack
Class C Photoluminescent Polyester			
835888	150	Class C	1 / Pack
Class B Photoluminescent Polypropylene			
835880	150	Class B	1 / Pack
Class C Photoluminescent Polypropylene			
835881	150	Class C	1 / Pack
Class C Photoluminescent Aluminium			
835879	150	Class C	1 / Pack



PICTOGRAMS ON ROLLS

Order Ref.	Diameter (mm)	Total Qty/Pack
Laminated Polyester		
831050	25	250 / Roll
831052	50	250 / Roll
831054	100	250 / Roll

Complies with EN ISO 7010

M032 : WEAR ANTI-STATIC FOOTWEAR

In certain environments it is essential to wear antistatic shoes. ESD compliant shoes are ideal for electricians and professionals at risk of electrical shocks.



SIGNS

Order Ref.	Diameter (mm)	Total Qty/Pack
Laminated Polyester		
831070	50	2 / Pack
831072	100	1 / Pack
831073	200	1 / Pack
831074	315	1 / Pack
Polypropylene		
831076	100	1 / Pack
831077	200	1 / Pack
831078	315	1 / Pack
831079	400	1 / Pack
Aluminium		
831080	100	1 / Pack
831081	200	1 / Pack
831082	315	1 / Pack

FLOOR MARKING

Order Ref.	Diameter (mm)	Total Qty/Pack
Anti-skid Laminated Polyester		
831075	500	1 / Pack

MINI-PICTOGRAMS

Order Ref.	Diameter (mm)	Total Qty/Pack
Laminated Polyester		
831068	25	7 / Pack
Vinyl		
831066	15	54 / Pack



PHOTOLUMINESCENT SIGNS

Order Ref.	Diameter (mm)	Class	Total Qty/Pack
Class B Photoluminescent Polyester			
835893	150	Class B	1 / Pack
Class C Photoluminescent Polyester			
835894	150	Class C	1 / Pack
Class B Photoluminescent Polypropylene			
835890	150	Class B	1 / Pack
Class C Photoluminescent Polypropylene			
835892	150	Class C	1 / Pack
Class C Photoluminescent Aluminium			
835889	150	Class C	1 / Pack



PICTOGRAMS ON ROLLS

Order Ref.	Diameter (mm)	Total Qty/Pack
Laminated Polyester		
831067	25	250 / Roll
831069	50	250 / Roll
831071	100	250 / Roll



M033 : CLOSE SAFETY BAR OF CHAIRLIFT

To prevent accidental falls, the security bar of the chairlift must be closed once the user is seated.



SIGNS

Order Ref.	Diameter (mm)	Total Qty/Pack
Laminated Polyester		
135384	100	1 / Pack
135385	150	1 / Pack
135386	200	1 / Pack
Polypropylene		
135378	100	1 / Pack
135379	150	1 / Pack
135380	200	1 / Pack
Aluminium		
135381	100	1 / Pack
135382	150	1 / Pack
135383	200	1 / Pack



PHOTOLUMINESCENT SIGNS

Order Ref.	Diameter (mm)	Class	Total Qty/Pack
Class B Photoluminescent Polyester			
135393	100	Class B	1 / Pack
135394	150	Class B	1 / Pack
135395	200	Class B	1 / Pack
Class C Photoluminescent Polyester			
135402	100	Class C	1 / Pack
135408	150	Class C	1 / Pack
135409	200	Class C	1 / Pack
Class B Photoluminescent Polypropylene			
135387	100	Class B	1 / Pack
135388	150	Class B	1 / Pack
135389	200	Class B	1 / Pack
Class C Photoluminescent Polypropylene			
135396	100	Class C	1 / Pack
135397	150	Class C	1 / Pack
135398	200	Class C	1 / Pack
Class C Photoluminescent Aluminium			
135399	100	Class C	1 / Pack
135400	150	Class C	1 / Pack
135401	200	Class C	1 / Pack



M034 : OPEN SAFETY BAR OF CHAIRLIFT

At the top of the ascent, the user is notified when to open the security barrier to get off the chair lift quickly.



SIGNS

Order Ref.	Diameter (mm)	Total Qty/Pack
Laminated Polyester		
135416	100	1 / Pack
135417	150	1 / Pack
135418	200	1 / Pack
Polypropylene		
135410	100	1 / Pack
135411	150	1 / Pack
135412	200	1 / Pack
Aluminium		
135413	100	1 / Pack
135414	150	1 / Pack
135415	200	1 / Pack



PHOTOLUMINESCENT SIGNS

Order Ref.	Diameter (mm)	Class	Total Qty/Pack
Class B Photoluminescent Polyester			
135425	100	Class B	1 / Pack
135426	150	Class B	1 / Pack
135427	200	Class B	1 / Pack
Class C Photoluminescent Polyester			
135434	100	Class C	1 / Pack
135435	150	Class C	1 / Pack
135436	200	Class C	1 / Pack
Class B Photoluminescent Polypropylene			
135419	100	Class B	1 / Pack
135420	150	Class B	1 / Pack
135421	200	Class B	1 / Pack
Class C Photoluminescent Polypropylene			
135428	100	Class C	1 / Pack
135429	150	Class C	1 / Pack
135430	200	Class C	1 / Pack
Class C Photoluminescent Aluminium			
135431	100	Class C	1 / Pack
135432	150	Class C	1 / Pack
135433	200	Class C	1 / Pack

i For all material properties and applications, see pages 4-5

BRADY Customise-it See page 196 to order your custom-made signs.

Complies with EN ISO 7010

M035 : IMMEDIATELY LEAVE THE TOW-TRACK IN THE EVENT OF FALLING

It is possible to fall when using some mechanical lifts. It is therefore imperative to immediately leave the slope to avoid being struck by the next user.



SIGNS

Order Ref.	Diameter (mm)	Total Qty/Pack
Laminated Polyester		
135443	100	1 / Pack
135444	150	1 / Pack
135445	200	1 / Pack
Polypropylene		
135437	100	1 / Pack
135438	150	1 / Pack
135439	200	1 / Pack
Aluminium		
135440	100	1 / Pack
135441	150	1 / Pack
135442	200	1 / Pack



PHOTOLUMINESCENT SIGNS

Order Ref.	Diameter (mm)	Class	Total Qty/Pack
Class B Photoluminescent Polyester			
135452	100	Class B	1 / Pack
135453	150	Class B	1 / Pack
135454	200	Class B	1 / Pack
Class C Photoluminescent Polyester			
135461	100	Class C	1 / Pack
135462	150	Class C	1 / Pack
135463	200	Class C	1 / Pack
Class B Photoluminescent Polypropylene			
135446	100	Class B	1 / Pack
135447	150	Class B	1 / Pack
135448	200	Class B	1 / Pack
Class C Photoluminescent Polypropylene			
135455	100	Class C	1 / Pack
135456	150	Class C	1 / Pack
135457	200	Class C	1 / Pack
Class C Photoluminescent Aluminium			
135458	100	Class C	1 / Pack
135459	150	Class C	1 / Pack
135460	200	Class C	1 / Pack

Complies with EN ISO 7010

M036 : LIFT SKI TIPS

When using chairlifts, lift the front tips of the skis.



SIGNS

Order Ref.	Diameter (mm)	Total Qty/Pack
Laminated Polyester		
135470	100	1 / Pack
135471	150	1 / Pack
135472	200	1 / Pack
Polypropylene		
135464	100	1 / Pack
135465	150	1 / Pack
135466	200	1 / Pack
Aluminium		
135467	100	1 / Pack
135468	150	1 / Pack
135469	200	1 / Pack



PHOTOLUMINESCENT SIGNS

Order Ref.	Diameter (mm)	Class	Total Qty/Pack
Class B Photoluminescent Polyester			
135479	100	Class B	1 / Pack
135480	150	Class B	1 / Pack
135481	200	Class B	1 / Pack
Class C Photoluminescent Polyester			
135488	100	Class C	1 / Pack
135489	150	Class C	1 / Pack
135490	200	Class C	1 / Pack
Class B Photoluminescent Polypropylene			
135473	100	Class B	1 / Pack
135474	150	Class B	1 / Pack
135475	200	Class B	1 / Pack
Class C Photoluminescent Polypropylene			
135482	100	Class C	1 / Pack
135483	150	Class C	1 / Pack
135484	200	Class C	1 / Pack
Class C Photoluminescent Aluminium			
135485	100	Class C	1 / Pack
135486	150	Class C	1 / Pack
135487	200	Class C	1 / Pack



M037 : CLOSE AND SECURE HATCHES IN LAUNCH SEQUENCE

Symbol taken from marine aids.



SIGNS

Order Ref.	Diameter (mm)	Total Qty/Pack
Laminated Polyester		
135497	100	1 / Pack
135498	150	1 / Pack
135499	200	1 / Pack
Polypropylene		
135491	100	1 / Pack
135492	150	1 / Pack
135493	200	1 / Pack
Aluminium		
135494	100	1 / Pack
135495	150	1 / Pack
135496	200	1 / Pack



PHOTOLUMINESCENT SIGNS

Order Ref.	Diameter (mm)	Class	Total Qty/ Pack
Class B Photoluminescent Polyester			
135506	100	Class B	1 / Pack
135507	150	Class B	1 / Pack
135508	200	Class B	1 / Pack
Class C Photoluminescent Polyester			
135515	100	Class C	1 / Pack
135516	150	Class C	1 / Pack
135517	200	Class C	1 / Pack
Class B Photoluminescent Polypropylene			
135500	100	Class B	1 / Pack
135501	150	Class B	1 / Pack
135502	200	Class B	1 / Pack
Class C Photoluminescent Polypropylene			
135509	100	Class C	1 / Pack
135510	150	Class C	1 / Pack
135511	200	Class C	1 / Pack
Class C Photoluminescent Aluminium			
135512	100	Class C	1 / Pack
135513	150	Class C	1 / Pack
135514	200	Class C	1 / Pack



M038 : START ENGINE IN LAUNCH SEQUENCE

Symbol taken from marine aids.



SIGNS

Order Ref.	Diameter (mm)	Total Qty/Pack
Laminated Polyester		
135524	100	1 / Pack
135525	150	1 / Pack
135526	200	1 / Pack
Polypropylene		
135518	100	1 / Pack
135519	150	1 / Pack
135520	200	1 / Pack
Aluminium		
135521	100	1 / Pack
135522	150	1 / Pack
135523	200	1 / Pack



PHOTOLUMINESCENT SIGNS

Order Ref.	Diameter (mm)	Class	Total Qty/ Pack
Class B Photoluminescent Polyester			
135533	100	Class B	1 / Pack
135534	150	Class B	1 / Pack
135535	200	Class B	1 / Pack
Class C Photoluminescent Polyester			
135542	100	Class C	1 / Pack
135543	150	Class C	1 / Pack
135544	200	Class C	1 / Pack
Class B Photoluminescent Polypropylene			
135527	100	Class B	1 / Pack
135528	150	Class B	1 / Pack
135529	200	Class B	1 / Pack
Class C Photoluminescent Polypropylene			
135536	100	Class C	1 / Pack
135537	150	Class C	1 / Pack
135538	200	Class C	1 / Pack
Class C Photoluminescent Aluminium			
135539	100	Class C	1 / Pack
135540	150	Class C	1 / Pack
135541	200	Class C	1 / Pack

i For all material properties and applications, see pages 4-5

BRADY Customise-it See page 196 to order your custom-made signs.

Complies with EN ISO 7010

M039 : LOWER LIFEBOAT TO THE WATER IN LAUNCH SEQUENCE

Symbol taken from marine aids.



PHOTOLUMINESCENT SIGNS

Order Ref.	Diameter (mm)	Class	Total Qty/ Pack
Class B Photoluminescent Polyester			
135549	150	Class B	1 / Pack
135550	200	Class B	1 / Pack
Class C Photoluminescent Polyester			
135555	150	Class C	1 / Pack
135556	200	Class C	1 / Pack
Class B Photoluminescent Polypropylene			
135545	150	Class B	1 / Pack
135546	200	Class B	1 / Pack
Class C Photoluminescent Polypropylene			
135551	150	Class C	1 / Pack
135552	200	Class C	1 / Pack
Class C Photoluminescent Aluminium			
135553	150	Class C	1 / Pack
135554	200	Class C	1 / Pack

Complies with EN ISO 7010

M040 : LOWER LIFERAFT TO THE WATER IN LAUNCH SEQUENCE

Symbol taken from marine aids.



PHOTOLUMINESCENT SIGNS

Order Ref.	Diameter (mm)	Class	Total Qty/ Pack
Class B Photoluminescent Polyester			
135561	150	Class B	1 / Pack
135562	200	Class B	1 / Pack
Class C Photoluminescent Polyester			
135567	150	Class C	1 / Pack
135568	200	Class C	1 / Pack
Class B Photoluminescent Polypropylene			
135557	150	Class B	1 / Pack
135558	200	Class B	1 / Pack
Class C Photoluminescent Polypropylene			
135563	150	Class C	1 / Pack
135564	200	Class C	1 / Pack
Class C Photoluminescent Aluminium			
135565	150	Class C	1 / Pack
135566	200	Class C	1 / Pack

Complies with EN ISO 7010

M041 : LOWER RESCUE BOAT TO THE WATER IN LAUNCH SEQUENCE

Symbol taken from marine aids.



PHOTOLUMINESCENT SIGNS

Order Ref.	Diameter (mm)	Class	Total Qty/ Pack
Class B Photoluminescent Polyester			
135573	150	Class B	1 / Pack
135574	200	Class B	1 / Pack
Class C Photoluminescent Polyester			
135579	150	Class C	1 / Pack
135580	200	Class C	1 / Pack
Class B Photoluminescent Polypropylene			
135569	150	Class B	1 / Pack
135570	200	Class B	1 / Pack
Class C Photoluminescent Polypropylene			
135575	150	Class C	1 / Pack
135576	200	Class C	1 / Pack
Class C Photoluminescent Aluminium			
135577	150	Class C	1 / Pack
135578	200	Class C	1 / Pack

Complies with EN ISO 7010

M042 : RELEASE FALLS IN LAUNCH SEQUENCE

Symbol taken from marine aids.



PHOTOLUMINESCENT SIGNS

Order Ref.	Diameter (mm)	Class	Total Qty/ Pack
Class B Photoluminescent Polyester			
135585	150	Class B	1 / Pack
135586	200	Class B	1 / Pack
Class C Photoluminescent Polyester			
135591	150	Class C	1 / Pack
135592	200	Class C	1 / Pack
Class B Photoluminescent Polypropylene			
135581	150	Class B	1 / Pack
135582	200	Class B	1 / Pack
Class C Photoluminescent Polypropylene			
135587	150	Class C	1 / Pack
135588	200	Class C	1 / Pack
Class C Photoluminescent Aluminium			
135589	150	Class C	1 / Pack
135590	200	Class C	1 / Pack

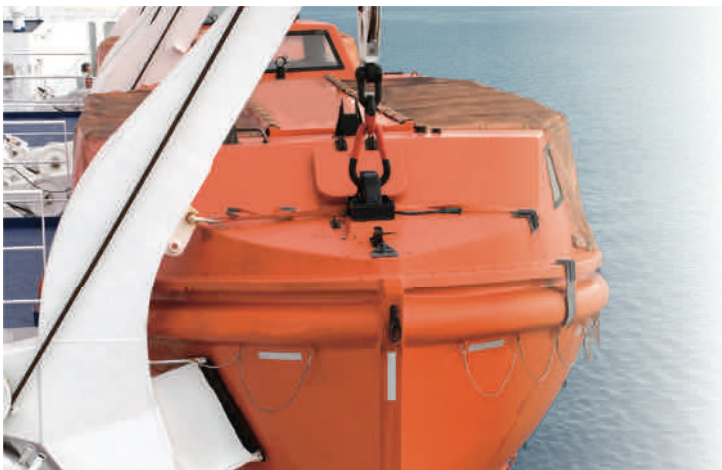

i For all material properties and applications, see pages 4-5

BRADY Customise-it See page 196 to order your custom-made signs.



M043 : START WATER SPRAY IN LAUNCH SEQUENCE

Symbol taken from marine aids.

PHOTOLUMINESCENT SIGNS

Order Ref.	Diameter (mm)	Class	Total Qty/ Pack
Class B Photoluminescent Polyester			
135597	150	Class B	1 / Pack
135598	200	Class B	1 / Pack
Class C Photoluminescent Polyester			
135603	150	Class C	1 / Pack
135604	200	Class C	1 / Pack
Class B Photoluminescent Polypropylene			
135593	150	Class B	1 / Pack
135594	200	Class B	1 / Pack
Class C Photoluminescent Polypropylene			
135599	150	Class C	1 / Pack
135600	200	Class C	1 / Pack
Class C Photoluminescent Aluminium			
135601	150	Class C	1 / Pack
135602	200	Class C	1 / Pack

Complies with EN ISO 7010



M044 : START AIR SUPPLY IN LAUNCH SEQUENCE

Symbol taken from marine aids.

PHOTOLUMINESCENT SIGNS

Order Ref.	Diameter (mm)	Class	Total Qty/ Pack
Class B Photoluminescent Polyester			
135609	150	Class B	1 / Pack
135610	200	Class B	1 / Pack
Class C Photoluminescent Polyester			
135615	150	Class C	1 / Pack
135616	200	Class C	1 / Pack
Class B Photoluminescent Polypropylene			
135605	150	Class B	1 / Pack
135606	200	Class B	1 / Pack
Class C Photoluminescent Polypropylene			
135611	150	Class C	1 / Pack
135612	200	Class C	1 / Pack
Class C Photoluminescent Aluminium			
135613	150	Class C	1 / Pack
135614	200	Class C	1 / Pack

Complies with EN ISO 7010



M045 : RELEASE LIFEBOAT GRIPES IN LAUNCH SEQUENCE

Symbol taken from marine aids.

PHOTOLUMINESCENT SIGNS

Order Ref.	Diameter (mm)	Class	Total Qty/ Pack
Class B Photoluminescent Polyester			
135621	150	Class B	1 / Pack
135622	200	Class B	1 / Pack
Class C Photoluminescent Polyester			
135627	150	Class C	1 / Pack
135628	200	Class C	1 / Pack
Class B Photoluminescent Polypropylene			
135617	150	Class B	1 / Pack
135618	200	Class B	1 / Pack
Class C Photoluminescent Polypropylene			
135623	150	Class C	1 / Pack
135624	200	Class C	1 / Pack
Class C Photoluminescent Aluminium			
135625	150	Class C	1 / Pack
135626	200	Class C	1 / Pack

Complies with EN ISO 7010

M046 : SECURE GAS CYLINDERS

To prevent any movement which may have serious consequences, gas bottles must be securely fixed, that is fastened in a way that prevents any fall or movement.



SIGNS

Order Ref.	Diameter (mm)	Total Qty/Pack
Laminated Polyester		
135635	100	1 / Pack
135636	150	1 / Pack
135637	200	1 / Pack
Polypropylene		
135629	100	1 / Pack
135630	150	1 / Pack
135631	200	1 / Pack
138876	315	1 / Pack
Aluminium		
135632	100	1 / Pack
135633	150	1 / Pack
135634	200	1 / Pack
138946	315	1 / Pack



PHOTOLUMINESCENT SIGNS

Order Ref.	Diameter (mm)	Class	Total Qty/Pack
Class B Photoluminescent Polyester			
135644	100	Class B	1 / Pack
135645	150	Class B	1 / Pack
135646	200	Class B	1 / Pack
Class C Photoluminescent Polyester			
135653	100	Class C	1 / Pack
135654	150	Class C	1 / Pack
135655	200	Class C	1 / Pack
Class B Photoluminescent Polypropylene			
135638	100	Class B	1 / Pack
135639	150	Class B	1 / Pack
135640	200	Class B	1 / Pack
Class C Photoluminescent Polypropylene			
135647	100	Class C	1 / Pack
135648	150	Class C	1 / Pack
135649	200	Class C	1 / Pack
Class C Photoluminescent Aluminium			
135650	100	Class C	1 / Pack
135651	150	Class C	1 / Pack
135652	200	Class C	1 / Pack

Complies with EN ISO 7010

M047 : USE SELF-CONTAINED BREATHING APPLIANCE

In an oxygen-free or hazardous gas environment, an individual breathing apparatus is compulsory.



SIGNS

Order Ref.	Diameter (mm)	Total Qty/Pack
Laminated Polyester		
135662	100	1 / Pack
135663	150	1 / Pack
135664	200	1 / Pack
Polypropylene		
135656	100	1 / Pack
135657	150	1 / Pack
135658	200	1 / Pack
138904	315	1 / Pack
Aluminium		
135659	100	1 / Pack
135660	150	1 / Pack
135661	200	1 / Pack



PHOTOLUMINESCENT SIGNS

Order Ref.	Diameter (mm)	Class	Total Qty/Pack
Class B Photoluminescent Polyester			
135671	100	Class B	1 / Pack
135672	150	Class B	1 / Pack
135673	200	Class B	1 / Pack
Class C Photoluminescent Polyester			
135680	100	Class C	1 / Pack
135681	150	Class C	1 / Pack
135682	200	Class C	1 / Pack
Class B Photoluminescent Polypropylene			
135665	100	Class B	1 / Pack
135666	150	Class B	1 / Pack
135667	200	Class B	1 / Pack
Class C Photoluminescent Polypropylene			
135674	100	Class C	1 / Pack
135675	150	Class C	1 / Pack
135676	200	Class C	1 / Pack
Class C Photoluminescent Aluminium			
135677	100	Class C	1 / Pack
135678	150	Class C	1 / Pack
135679	200	Class C	1 / Pack

i For all material properties and applications, see pages 4-5

BRADY Customise-it See page 196 to order your custom-made signs.



M048 : USE GAS DETECTOR

In a space that is likely to contain odourless or colourless gas, a gas detector must be used to raise the alarm in the event of danger. This device is essential when working in a confined space, also known as an asphyxiating atmosphere (W041, page 106)



SIGNS



Order Ref.	Diameter (mm)	Total Qty/Pack
Laminated Polyester		
135689	100	1 / Pack
135690	150	1 / Pack
135691	200	1 / Pack
139072	315	1 / Pack
Polypropylene		
135683	100	1 / Pack
135684	150	1 / Pack
135685	200	1 / Pack
139029	315	1 / Pack
Aluminium		
135686	100	1 / Pack
135687	150	1 / Pack
135688	200	1 / Pack

PHOTOLUMINESCENT SIGNS



Order Ref.	Diameter (mm)	Class	Total Qty/Pack
Class B Photoluminescent Polyester			
135698	100	Class B	1 / Pack
135699	150	Class B	1 / Pack
135700	200	Class B	1 / Pack
Class C Photoluminescent Polyester			
135711	100	Class C	1 / Pack
135712	150	Class C	1 / Pack
135713	200	Class C	1 / Pack
Class B Photoluminescent Polypropylene			
135692	100	Class B	1 / Pack
135693	150	Class B	1 / Pack
135694	200	Class B	1 / Pack
Class C Photoluminescent Polypropylene			
135701	100	Class C	1 / Pack
135703	150	Class C	1 / Pack
135705	200	Class C	1 / Pack
Class C Photoluminescent Aluminium			
135708	100	Class C	1 / Pack
135709	150	Class C	1 / Pack
135710	200	Class C	1 / Pack



M049 : WEAR PROTECTIVE ROLL SPORT EQUIPMENT

In roller sports areas, wearing suitable protection is required, such as a helmet, elbow guards, knee guards or wrist guards.



SIGNS

Order Ref.	Diameter (mm)	Total Qty/Pack
Laminated Polyester		
135720	100	1 / Pack
135721	150	1 / Pack
135722	200	1 / Pack
Polypropylene		
135714	100	1 / Pack
135715	150	1 / Pack
135716	200	1 / Pack
Aluminium		
135717	100	1 / Pack
135718	150	1 / Pack
135719	200	1 / Pack



PHOTOLUMINESCENT SIGNS

Order Ref.	Diameter (mm)	Class	Total Qty/Pack
Class B Photoluminescent Polyester			
135729	100	Class B	1 / Pack
135730	150	Class B	1 / Pack
135731	200	Class B	1 / Pack
Class C Photoluminescent Polyester			
135738	100	Class C	1 / Pack
135739	150	Class C	1 / Pack
135740	200	Class C	1 / Pack
Class B Photoluminescent Polypropylene			
135723	100	Class B	1 / Pack
135724	150	Class B	1 / Pack
135725	200	Class B	1 / Pack
Class C Photoluminescent Polypropylene			
135732	100	Class C	1 / Pack
135733	150	Class C	1 / Pack
135734	200	Class C	1 / Pack
Class C Photoluminescent Aluminium			
135735	100	Class C	1 / Pack
135736	150	Class C	1 / Pack
135737	200	Class C	1 / Pack

Complies with EN ISO 7010

M050 : ALIGHTING FROM TOBOGGAN TO THE LEFT

This mandatory sign informs the general public of the proper code of conduct at a facility with a toboggan slide.



SIGNS



Order Ref.	Diameter (mm)	Total Qty/ Pack
Laminated Polyester		
197879	100	1 / Pack
197880	150	1 / Pack
197881	200	1 / Pack
Polypropylene		
197882	100	1 / Pack
197883	150	1 / Pack
197884	200	1 / Pack
Aluminium		
197885	100	1 / Pack
197886	150	1 / Pack
197887	200	1 / Pack

PHOTOLUMINESCENT SIGNS



Order Ref.	Diameter (mm)	Class	Total Qty/ Pack
Class B Photoluminescent Polyester			
197888	100	Class B	1 / Pack
197889	150	Class B	1 / Pack
197890	200	Class B	1 / Pack
Class C Photoluminescent Polyester			
197891	100	Class C	1 / Pack
197892	150	Class C	1 / Pack
197893	200	Class C	1 / Pack
Class B Photoluminescent Polypropylene			
197894	100	Class B	1 / Pack
197895	150	Class B	1 / Pack
197896	200	Class B	1 / Pack
Class C Photoluminescent Polypropylene			
197897	100	Class C	1 / Pack
197898	150	Class C	1 / Pack
197899	200	Class C	1 / Pack
Class C Photoluminescent Aluminium			
197900	100	Class C	1 / Pack
197901	150	Class C	1 / Pack
197902	200	Class C	1 / Pack

Complies with EN ISO 7010

M051 : ALIGHTING FROM TOBOGGAN TO THE RIGHT

This mandatory sign informs the general public of the proper code of conduct at a facility with a toboggan slide.



SIGNS



Order Ref.	Diameter (mm)	Total Qty/ Pack
Laminated Polyester		
197903	100	1 / Pack
197904	150	1 / Pack
197905	200	1 / Pack
Polypropylene		
197906	100	1 / Pack
197907	150	1 / Pack
197908	200	1 / Pack
Aluminium		
197909	100	1 / Pack
197910	150	1 / Pack
197911	200	1 / Pack

PHOTOLUMINESCENT SIGNS



Order Ref.	Diameter (mm)	Class	Total Qty/ Pack
Class B Photoluminescent Polyester			
197912	100	Class B	1 / Pack
197913	150	Class B	1 / Pack
197914	200	Class B	1 / Pack
Class C Photoluminescent Polyester			
197915	100	Class C	1 / Pack
197916	150	Class C	1 / Pack
197917	200	Class C	1 / Pack
Class B Photoluminescent Polypropylene			
197918	100	Class B	1 / Pack
197919	150	Class B	1 / Pack
197920	200	Class B	1 / Pack
Class C Photoluminescent Polypropylene			
197921	100	Class C	1 / Pack
197922	150	Class C	1 / Pack
197923	200	Class C	1 / Pack
Class C Photoluminescent Aluminium			
197924	100	Class C	1 / Pack
197925	150	Class C	1 / Pack
197926	200	Class C	1 / Pack



M052 : KEEP DISTANCES

This mandatory sign informs the general public of the proper code of conduct at a facility with a toboggan slide.



SIGNS

Order Ref.	Diameter (mm)	Total Qty/ Pack
Laminated Polyester		
197927	100	1 / Pack
197928	150	1 / Pack
197929	200	1 / Pack
Polypropylene		
197930	100	1 / Pack
197931	150	1 / Pack
197932	200	1 / Pack
Aluminium		
197933	100	1 / Pack
197934	150	1 / Pack
197935	200	1 / Pack



PHOTOLUMINESCENT SIGNS

Order Ref.	Diameter (mm)	Class	Total Qty/ Pack
Class B Photoluminescent Polyester			
197936	100	Class B	1 / Pack
197937	150	Class B	1 / Pack
197938	200	Class B	1 / Pack
Class C Photoluminescent Polyester			
197939	100	Class C	1 / Pack
197940	150	Class C	1 / Pack
197941	200	Class C	1 / Pack
Class B Photoluminescent Polypropylene			
197942	100	Class B	1 / Pack
197943	150	Class B	1 / Pack
197944	200	Class B	1 / Pack
Class C Photoluminescent Polypropylene			
197945	100	Class C	1 / Pack
197946	150	Class C	1 / Pack
197947	200	Class C	1 / Pack
Class C Photoluminescent Aluminium			
197948	100	Class C	1 / Pack
197949	150	Class C	1 / Pack
197950	200	Class C	1 / Pack



PIC 280 : WEAR PROTECTIVE FOOTWEAR

In certain environments, to prevent external germs from being spread by footwear, shoe-covers are provided at the entrance.



SIGNS

Order Ref.	Diameter (mm)	Total Qty/Pack
Laminated Polyester		
254161	100	1 / Pack
254162	200	1 / Pack
222565	315	1 / Pack
Polypropylene		
222643	100	1 / Pack
252159	200	1 / Pack
252160	315	1 / Pack
Aluminium		
257924	100	1 / Pack
257925	200	1 / Pack
257926	315	1 / Pack

WEAR PROTECTIVE HEADGEAR

In the agro-food business, the head may not be at risk in any event, but hair can fall into food preparation. It is therefore important to wear a protective cap, also known as a 'charlotte'.

PIC 269



SIGNS

Order Ref.	Diameter (mm)	Total Qty/Pack
Laminated Polyester		
250137	100	1 / Pack
250138	200	1 / Pack
222628	315	1 / Pack
Polypropylene		
222629	100	1 / Pack
252139	200	1 / Pack
252140	315	1 / Pack
Aluminium		
257912	100	1 / Pack
255136	200	1 / Pack
255137	315	1 / Pack

FLOOR MARKING

Order Ref.	Diameter (mm)	Total Qty/Pack
Anti-skid Laminated Polyester		
223648	500	1 / Pack

PIC 286



SIGNS

Order Ref.	Diameter (mm)	Total Qty/Pack
Laminated Polyester		
251264	100	1 / Pack
251265	200	1 / Pack
222635	315	1 / Pack
Polypropylene		
222636	100	1 / Pack
252300	200	1 / Pack
252301	315	1 / Pack
Aluminium		
257913	100	1 / Pack
257914	200	1 / Pack
257915	315	1 / Pack

PIC 283 : WEAR PROTECTIVE HEADGEAR

In certain professions such as butchery, wearing a safety hat may be obligatory to prevent hair falling into food.



SIGNS

Order Ref.	Diameter (mm)	Total Qty/Pack
Laminated Polyester		
254167	100	1 / Pack
254168	200	1 / Pack
222630	315	1 / Pack
Polypropylene		
222631	100	1 / Pack
252165	200	1 / Pack
252166	315	1 / Pack
Aluminium		
222632	100	1 / Pack
222633	200	1 / Pack
222634	315	1 / Pack



PIC 281 : WEAR LIFE JACKET

On certain vessels, wearing a life jacket is obligatory on board. In other cases, they will only be used in the even of evacuation and will then be signalled by the symbols E044, E045, E046 (see page 43-44)



SIGNS

Order Ref.	Diameter (mm)	Total Qty/Pack
Laminated Polyester		
241163	100	1 / Pack
254164	200	1 / Pack
222654	315	1 / Pack
Polypropylene		
222655	100	1 / Pack
252161	200	1 / Pack
252162	315	1 / Pack
Aluminium		
222656	100	1 / Pack
222657	200	1 / Pack
222658	315	1 / Pack



PIC 1216 : WHEELCHAIR ACCESS

Owing to the new rules for access, a number of entry points have been developed to enable access for wheel-chairs and persons with reduced mobility. This symbol makes it possible to indicate them.

SIGNS

Order Ref.	Diameter (mm)	Total Qty/Pack
Laminated Polyester		
222780	100	1 / Pack
222781	200	1 / Pack
222782	315	1 / Pack
Polypropylene		
222783	100	1 / Pack
222784	200	1 / Pack
222785	315	1 / Pack
Aluminium		
222786	100	1 / Pack
222787	200	1 / Pack
222788	315	1 / Pack



PIC 2209 : WEAR LAB COATS

In certain industries such as laboratories, cotton overalls must be worn. This symbol indicate this at the appropriate points.

SIGNS

Order Ref.	Diameter (mm)	Total Qty/Pack
Laminated Polyester		
806870	100	1 / Pack
806873	200	1 / Pack
806876	315	1 / Pack
Polypropylene		
806871	100	1 / Pack
806874	200	1 / Pack
806877	315	1 / Pack
Aluminium		
806872	100	1 / Pack
806875	200	1 / Pack
806878	315	1 / Pack

PIC 2600 : SMOKING ALLOWED

Laws and regulations prohibit smoking in numerous places, both public and private. Certain areas have been adapted for smokers as a result. Indicating them makes it possible to restrict and optimise such spaces.



SIGNS

Order Ref.	Width (mm)	Height (mm)	Total Qty/ Pack
Laminated Polyester			
810917	100	100	1 / Pack
810919	200	200	1 / Pack
810921	315	315	1 / Pack
Polypropylene			
810918	100	100	1 / Pack
810920	200	200	1 / Pack
810922	315	315	1 / Pack
Aluminium			
810923	315	315	1 / Pack

PIC 901 : ELECTRONIC CIGARETTES ALLOWED

With the use of e-cigarettes, these signs make it possible to indicate the authorised areas.



SIGNS



Order Ref.	Width (mm)	Height (mm)	Total Qty/ Pack
Laminated Polyester			
138492	100	100	1 / Pack
138493	200	200	1 / Pack
Polypropylene			
138494	100	100	1 / Pack
138495	200	200	1 / Pack

SIGNS WITH TEXT



Order Ref.	Width (mm)	Height (mm)	Layout	Legend	Total Qty/ Pack
Laminated Polyester					
138496	210	297	Portrait	Electronic cigarettes allowed	1 Sign(s) / Pack
Polypropylene					
138501	210	297	Portrait	Electronic cigarettes allowed	1 Sign(s) / Pack

BRADY
Customise-it

Do you wish to create a different sign from the range offered? Contact us! To help you out, here are some non-exhaustive models.

It is possible to accumulate different types of pictograms on the same sign or label, thus enabling you to make up as many panels as you need.

Types of pictograms available:



Evacuation/safety



Fire prevention



Warning



Prohibition

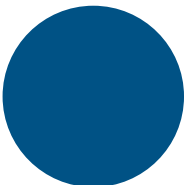

Mandatory

MODEL 1

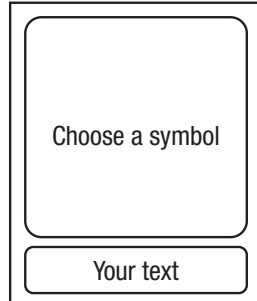

MODEL 2

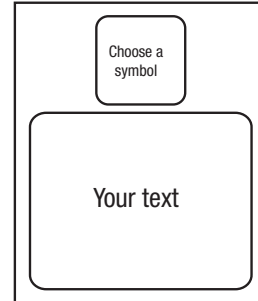

MODEL 3

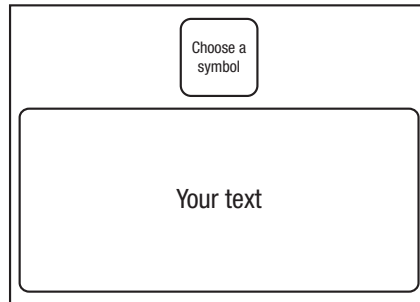

MODEL 4



MODEL 5

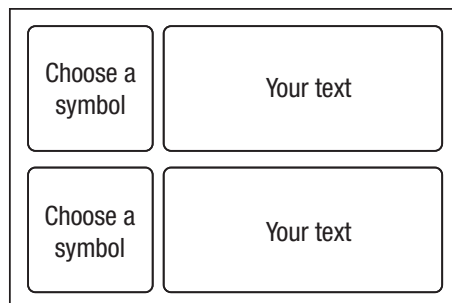

MODEL 6

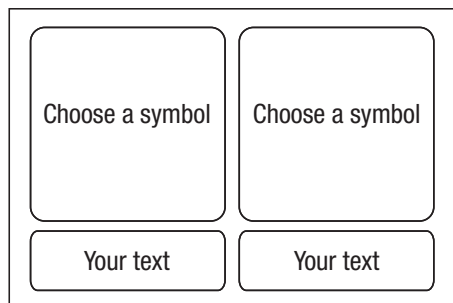

MODEL 7

Choose a symbol	Choose a symbol
Your text	Your text

MODEL 8

Choose a symbol	Your text
Choose a symbol	Your text
Choose a symbol	Your text

Compliant with the standard ISO 3864-2



MODEL 9

 WARNING WORD
Choose a symbol
Your text

MODEL 10

Choose a symbol	 WARNING WORD
	Your text

MODEL 11

	 WARNING WORD	Choose a second symbol
	Your text	

WARNING & COLOUR CODE

To improve the illustration of your labels, use a colour code as well as a suitable warning word, depending on your message. There are different alarm words and colours to warn about a danger, so choose the one that you need depending on the danger of the risk incurred:

- DANGER is the highest level of risk (risk of death)
- WARNING is an intermediate risk level (risk of serious injury)
- CAUTION is the lowest level of risk (risk of mild injury)





SAFETY SIGN SLIDERS

Brady's new Safety Sign Sliders are visual communication platforms for your facility that will communicate your most important safety and awareness messages to facility visitors and employees.

You ensure that you are displaying the most relevant information for your facility or area so that anyone entering that area is aware of how to keep themselves and others safe. This new system utilises an interchangeable insert feature (signs slide in/out) so you can customise your messages specific to the area, and can make changes as needed quickly and cost-effectively.

Pre-printed inserts are available, standard or custom. You can also use blank boards and print yourself the sign and messaging.

FEATURES AND ADVANTAGES

■ Brady's new Safety Sign Sliders are available in multiple formats

- Wall / Door hanging
- Blank boards available to be printed with a Brady Sign and Label printer
- 3 size variations to accommodate the space you have
 - 450 mm × 850 mm: 4 landscape boards
 - 420 mm × 825 mm: 4 portrait boards, format A4 (210 x 297 mm)
 - 296 mm × 650 mm: 4 portrait boards, format A5 (148 x 210 mm)

■ Interchangeable messaging

- Keep your employees and visitors safe by providing the most current and necessary messages for necessary PPE, caution and warning signage.

■ Customise your facilities!

- Over 100 stock messages are available but if you don't see the exact message you want for your facility, customise it! We can accommodate your requests for custom messaging, artwork, and any language versions. (see page 196 for our customised signs).

SIGN HOLDERS & INSERTS

Order Ref.	Width (mm)	Height (mm)	Description	Total Qty/Pack
Safety Sliders - Blank Board				
195902	450	830	Safety Sliders - Blank Board	1 Sign(s) / Pack
195903	420	820	Safety Sliders - Blank Board	1 Sign(s) / Pack
195904	296	650	Safety Sliders - Blank Board	1 Sign(s) / Pack
Safety Sliders - Blank Inserts				
195905	450	150	Safety Sliders - Blank Inserts	1 Sign(s) / Pack
195906	210	297	Safety Sliders - Blank Inserts	1 Sign(s) / Pack
195907	148	210	Safety Sliders - Blank Inserts	1 Sign(s) / Pack
Safety Sliders - Blank Title				
195908	420	150	Safety Sliders - Blank Title	1 Sign(s) / Pack
195909	296	150	Safety Sliders - Blank Title	1 Sign(s) / Pack
Safety Sliders - SAFETY INSTRUCTIONS Title				
195913	450	150	Safety Sliders - SAFETY INSTRUCTIONS Title	1 Sign(s) / Pack
195914	420	150	Safety Sliders - SAFETY INSTRUCTIONS Title	1 Sign(s) / Pack
195915	296	150	Safety Sliders - SAFETY INSTRUCTIONS Title	1 Sign(s) / Pack

* For the 450 x 830 mm sign, the blank title is for a blank insert, 450 x 150 mm

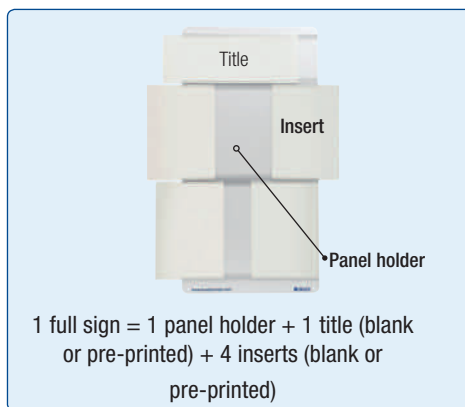





MOST POPULAR SAFETY SIGNS TO BE USED WITH SAFETY SIGNS SLIDERS

MANDATORY

	Legend	450 x 150 mm	A4	A5
	M002 Refer to instruction manual/booklet	818191	818186	818185
	M003 Wear ear protection	818340	818335	818334
	M004 Wear eye protection	818489	818484	818483
	M008 Wear safety footwear	819085	819080	819079
	M009 Wear protective gloves	819234	819229	819228
	M010 Wear protective clothing	819383	819378	819377
	M014 Wear head protection	819979	819974	819973
	M016 Wear a mask	820277	820272	820271
	M017 Wear respiratory protection	820426	820421	820420
	M021 Disconnect before carrying out maintenance or repair	821022	821017	821016
	M024 Use this walkway	821469	821464	821463

PROHIBITION

	Legend	450 x 150 mm	A4	A5
	P002 No smoking	822065	822060	822059
	P003 No open flame; Fire, open ignition source and smoking prohibited	822214	822209	822208
	P004 No thoroughfare	822363	822358	822357
	P005 Not drinking water	822512	822507	822506







>>

PROHIBITION

	Legend	450 x 150 mm	A4	A5
	P006 No access for fork lift trucks and other industrial vehicles	822661	822656	822655
	P007 No access for people with active implanted cardiac devices	822810	822805	822804
	P013 No activated mobile phones	823555	823550	823549
	P015 No reaching in	823853	823848	823847
	P018 No sitting	824151	824146	824145
	P021 No dogs	824598	824593	824592
	P022 No eating or drinking	824747	824742	824741
	P024 Do not walk or stand here	825045	825040	825039
	P029 No photography	825790	825785	825784
	PIC 209* No access for unauthorised persons	195922	195923	195924

*Not available in EN ISO 7010

WARNING

	Legend	450 x 150 mm	A4	A5
	W004 Warning; laser beam	826979	826974	826973
	W006 Warning; Magnetic field	827275	827270	827269
	W007 Warning; Floor level obstacle	827423	827418	827417
	W012 Warning; Electricity	828163	828158	828157
	W014 Warning; Fork lift trucks and other industrial vehicles	828459	828454	828453
	W015 Warning; Overhead load	828607	828602	828601
	W019 Warning; Crushing	829199	829194	829193



Maritime signage

NiteGlo™ and Xtra Glo™ glow-in-the-dark signs	202
Evacuation & First aid	203
Fire safety.....	207
Mandatory	216

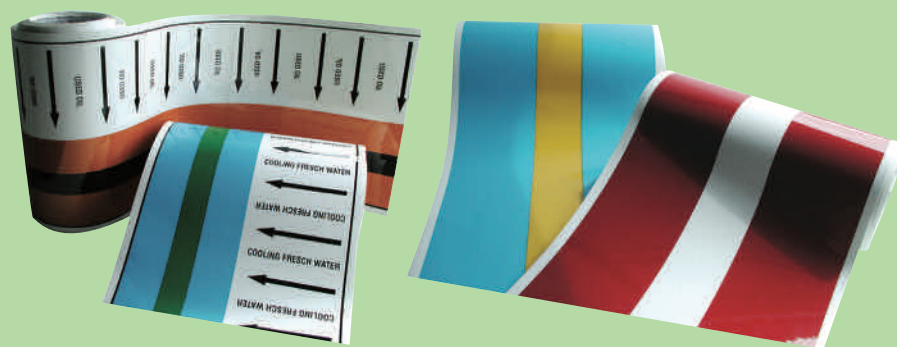

For shipping pipeline markers, contact us.

NITEGLO™ AND XTRA GLO™ GLOW-IN-THE-DARK SIGNS



Emergency occur every day on ferries, tankers, at airports and on rigs. Emergency situations are unpredictable, so a quick and efficient evacuation is essential for both staff and visitors. For this reason, clear and flexible safety signage is vital.

Nite Glo™ and Xtra Glo™ are effective products designed to offer emergency indications in the most effective way possible under the most difficult circumstances.

The range of lighting indicators is designed in self-adhesive laminated polyester (flexible material) and in high-quality rigid polypropylene. It may be used both outdoors and indoors.

Glow-in-the-dark signs require no upkeep, have zero maintenance cost and an unlimited lifetime.

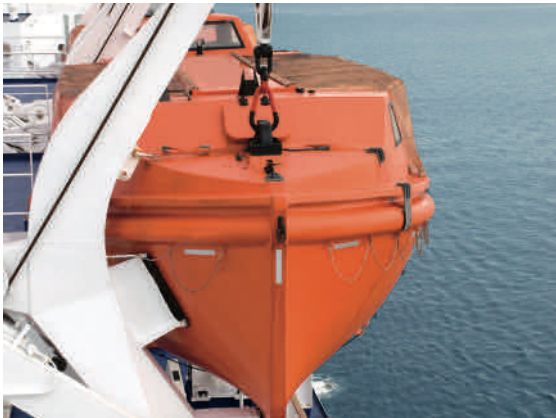

NITE-GLO XTRA-GLO

- Nite Glo™ indicates a class B glow-in-the-dark product, under the DIN 65710 standard
- Xtra Glo™ indicates a class C glow-in-the-dark product, under the DIN 65710 standard, which means these products will be visible for longer than a class B product with the same initial charge.
- Currently, as a minimum, class B quality is required for marine standards to demand a less significant investment. Class C remains, however, the solution that allows for additional security.

	Brightness after 10 minutes mcd/m ²	Brightness after 60 minutes mcd/m ²
IMO Resolution A.752 (18)	15	2
DIN 65710 Class B minimum	50	3
DIN 65710 Class C minimum	140	20
Nite Glo™	119	12,4
Xtra Glo™	180	23

10 minutes is the point of reference for the evacuation time of the occupants of a building, 60 minutes is the intervention time for rescuers.



Compliant with ISO 24409 standard

EVACUATION & FIRST AID

IMO301 – LIFEBOAT



Order Ref.	Width (mm)	Height (mm)	Class	Total Qty/Pack
Class B Photoluminescent Polyester				
195455	150	150	Class B	1 Sign(s) / Pack
Class C Photoluminescent Polyester				
195160	150	150	Class C	1 Sign(s) / Pack
Class B Photoluminescent Polypropylene				
195298	150	150	Class B	1 Sign(s) / Pack
Class C Photoluminescent Polypropylene				
195141	150	150	Class C	1 Sign(s) / Pack

IMO302 – LIFE RAFT



Order Ref.	Width (mm)	Height (mm)	Class	Total Qty/Pack
Class B Photoluminescent Polyester				
195456	150	150	Class B	1 Sign(s) / Pack
Class C Photoluminescent Polyester				
195161	150	150	Class C	1 Sign(s) / Pack
Class B Photoluminescent Polypropylene				
195299	150	150	Class B	1 Sign(s) / Pack
Class C Photoluminescent Polypropylene				
195142	150	150	Class C	1 Sign(s) / Pack

IMO303 – LIFE RAFT



Order Ref.	Width (mm)	Height (mm)	Class	Total Qty/Pack
Class B Photoluminescent Polyester				
195457	150	150	Class B	1 Sign(s) / Pack
Class C Photoluminescent Polyester				
195162	150	150	Class C	1 Sign(s) / Pack
Class B Photoluminescent Polypropylene				
195300	150	150	Class B	1 Sign(s) / Pack
Class C Photoluminescent Polypropylene				
195143	150	150	Class C	1 Sign(s) / Pack

IMO304 – LIFE RAFT FOR DEPLOYMENT BY DAVIT



Order Ref.	Width (mm)	Height (mm)	Class	Total Qty/Pack
Class B Photoluminescent Polyester				
195458	150	150	Class B	1 Sign(s) / Pack
Class C Photoluminescent Polyester				
195163	150	150	Class C	1 Sign(s) / Pack
Class B Photoluminescent Polypropylene				
195301	150	150	Class B	1 Sign(s) / Pack
Class C Photoluminescent Polypropylene				
195144	150	150	Class C	1 Sign(s) / Pack

IMO305 – COVERED SLIDE FOR MARINE EVACUATION



Order Ref.	Width (mm)	Height (mm)	Class	Total Qty/Pack
Class B Photoluminescent Polyester				
195459	150	150	Class B	1 Sign(s) / Pack
Class C Photoluminescent Polyester				
195164	150	150	Class C	1 Sign(s) / Pack
Class B Photoluminescent Polypropylene				
195302	150	150	Class B	1 Sign(s) / Pack
Class C Photoluminescent Polypropylene				
195145	150	150	Class C	1 Sign(s) / Pack

IMO306 – MARINE EVACUATION SLIDE



Order Ref.	Width (mm)	Height (mm)	Class	Total Qty/Pack
Class B Photoluminescent Polyester				
195460	150	150	Class B	1 Sign(s) / Pack
Class C Photoluminescent Polyester				
195165	150	150	Class C	1 Sign(s) / Pack
Class B Photoluminescent Polypropylene				
195303	150	150	Class B	1 Sign(s) / Pack
Class C Photoluminescent Polypropylene				
195146	150	150	Class C	1 Sign(s) / Pack

IMO307 – LIFELINE



Order Ref.	Width (mm)	Height (mm)	Class	Total Qty/Pack
Class B Photoluminescent Polyester				
195461	150	150	Class B	1 Sign(s) / Pack
Class C Photoluminescent Polyester				
195166	150	150	Class C	1 Sign(s) / Pack
Class B Photoluminescent Polypropylene				
195304	150	150	Class B	1 Sign(s) / Pack
Class C Photoluminescent Polypropylene				
195147	150	150	Class C	1 Sign(s) / Pack

IMO308 – LIFELINE WITH FLOATING LINE



Order Ref.	Width (mm)	Height (mm)	Class	Total Qty/Pack
Class B Photoluminescent Polyester				
195462	150	150	Class B	1 Sign(s) / Pack
Class C Photoluminescent Polyester				
195167	150	150	Class C	1 Sign(s) / Pack
Class B Photoluminescent Polypropylene				
195305	150	150	Class B	1 Sign(s) / Pack
Class C Photoluminescent Polypropylene				
195148	150	150	Class C	1 Sign(s) / Pack

IMO309 – LIFELINE WITH LIGHTING DEVICE



Order Ref.	Width (mm)	Height (mm)	Class	Total Qty/Pack
Class B Photoluminescent Polyester				
195463	150	150	Class B	1 Sign(s) / Pack
Class C Photoluminescent Polyester				
195168	150	150	Class C	1 Sign(s) / Pack
Class B Photoluminescent Polypropylene				
195306	150	150	Class B	1 Sign(s) / Pack
Class C Photoluminescent Polypropylene				
195149	150	150	Class C	1 Sign(s) / Pack

IMO310 – LIFELINE WITH LIGHTING AND SMOKE DEVICE



Order Ref.	Width (mm)	Height (mm)	Class	Total Qty/Pack
Class B Photoluminescent Polyester				
195464	150	150	Class B	1 Sign(s) / Pack
Class C Photoluminescent Polyester				
195108	150	150	Class C	1 Sign(s) / Pack
Class B Photoluminescent Polypropylene				
195307	150	150	Class B	1 Sign(s) / Pack
Class C Photoluminescent Polypropylene				
139512	150	150	Class C	1 Sign(s) / Pack

IMO311 – LIFE JACKET



Order Ref.	Width (mm)	Height (mm)	Class	Total Qty/Pack
Class B Photoluminescent Polyester				
195465	150	150	Class B	1 Sign(s) / Pack
Class C Photoluminescent Polyester				
195169	150	150	Class C	1 Sign(s) / Pack
Class B Photoluminescent Polypropylene				
195308	150	150	Class B	1 Sign(s) / Pack
Class C Photoluminescent Polypropylene				
195150	150	150	Class C	1 Sign(s) / Pack

IMO312 – LIFE JACKET FOR CHILDREN



Order Ref.	Width (mm)	Height (mm)	Class	Total Qty/Pack
Class B Photoluminescent Polyester				
195466	150	150	Class B	1 Sign(s) / Pack
Class C Photoluminescent Polyester				
195170	150	150	Class C	1 Sign(s) / Pack
Class B Photoluminescent Polypropylene				
195309	150	150	Class B	1 Sign(s) / Pack
Class C Photoluminescent Polypropylene				
195151	150	150	Class C	1 Sign(s) / Pack

EVACUATION & FIRST AID

IMO313 – SURVIVAL SUIT



Order Ref.	Width (mm)	Height (mm)	Class	Total Qty/Pack
Class B Photoluminescent Polyester				
195467	150	150	Class B	1 Sign(s) / Pack
Class C Photoluminescent Polyester				
195171	150	150	Class C	1 Sign(s) / Pack
Class B Photoluminescent Polypropylene				
195310	150	150	Class B	1 Sign(s) / Pack
Class C Photoluminescent Polypropylene				
195152	150	150	Class C	1 Sign(s) / Pack

IMO314 – PORTABLE VHF RADIO

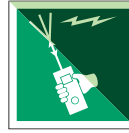

Order Ref.	Width (mm)	Height (mm)	Class	Total Qty/Pack
Class B Photoluminescent Polyester				
195468	150	150	Class B	1 Sign(s) / Pack
Class C Photoluminescent Polyester				
195172	150	150	Class C	1 Sign(s) / Pack
Class B Photoluminescent Polypropylene				
195311	150	150	Class B	1 Sign(s) / Pack
Class C Photoluminescent Polypropylene				
195153	150	150	Class C	1 Sign(s) / Pack

IMO315 – RADIO BEACON FOR LOCATING ACCIDENTS



Order Ref.	Width (mm)	Height (mm)	Class	Total Qty/Pack
Class B Photoluminescent Polyester				
195469	150	150	Class B	1 Sign(s) / Pack
Class C Photoluminescent Polyester				
195173	150	150	Class C	1 Sign(s) / Pack
Class B Photoluminescent Polypropylene				
195312	150	150	Class B	1 Sign(s) / Pack
Class C Photoluminescent Polypropylene				
139513	150	150	Class C	1 Sign(s) / Pack

IMO316 – SEARCH AND RESCUE TRANSPONDER

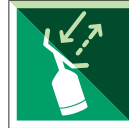

Order Ref.	Width (mm)	Height (mm)	Class	Total Qty/Pack
Class B Photoluminescent Polyester				
195470	150	150	Class B	1 Sign(s) / Pack
Class C Photoluminescent Polyester				
195174	150	150	Class C	1 Sign(s) / Pack
Class B Photoluminescent Polypropylene				
195313	150	150	Class B	1 Sign(s) / Pack
Class C Photoluminescent Polypropylene				
195154	150	150	Class C	1 Sign(s) / Pack

IMO317 – DISTRESS SIGNAL ON SURVIVAL CRAFT



Order Ref.	Width (mm)	Height (mm)	Class	Total Qty/Pack
Class B Photoluminescent Polyester				
195471	150	150	Class B	1 Sign(s) / Pack
Class C Photoluminescent Polyester				
195175	150	150	Class C	1 Sign(s) / Pack
Class B Photoluminescent Polypropylene				
195314	150	150	Class B	1 Sign(s) / Pack
Class C Photoluminescent Polypropylene				
195155	150	150	Class C	1 Sign(s) / Pack

IMO318 – PARACHUTE FLARE BOMB



Order Ref.	Width (mm)	Height (mm)	Class	Total Qty/Pack
Class B Photoluminescent Polyester				
195472	150	150	Class B	1 Sign(s) / Pack
Class C Photoluminescent Polyester				
195176	150	150	Class C	1 Sign(s) / Pack
Class B Photoluminescent Polypropylene				
195315	150	150	Class B	1 Sign(s) / Pack
Class C Photoluminescent Polypropylene				
195156	150	150	Class C	1 Sign(s) / Pack

IMO319 – DEVICE FOR LAUNCHING BUOYANT LINE



Order Ref.	Width (mm)	Height (mm)	Class	Total Qty/Pack
Class B Photoluminescent Polyester				
195473	150	150	Class B	1 Sign(s) / Pack
Class C Photoluminescent Polyester				
195177	150	150	Class C	1 Sign(s) / Pack
Class B Photoluminescent Polypropylene				
195316	150	150	Class B	1 Sign(s) / Pack
Class C Photoluminescent Polypropylene				
195157	150	150	Class C	1 Sign(s) / Pack

IMO320 – ASSEMBLY POINT ON BOARD THE VESSEL



Order Ref.	Width (mm)	Height (mm)	Class	Total Qty/Pack
Class B Photoluminescent Polyester				
195474	150	150	Class B	1 Sign(s) / Pack
Class C Photoluminescent Polyester				
195178	150	150	Class C	1 Sign(s) / Pack
Class B Photoluminescent Polypropylene				
195317	150	150	Class B	1 Sign(s) / Pack
Class C Photoluminescent Polypropylene				
195158	150	150	Class C	1 Sign(s) / Pack

IMO321 – 90° DIRECTION ARROW



Order Ref.	Width (mm)	Height (mm)	Class	Total Qty/Pack
Class B Photoluminescent Polyester				
195475	150	150	Class B	1 Sign(s) / Pack
Class C Photoluminescent Polyester				
195179	150	150	Class C	1 Sign(s) / Pack
Class B Photoluminescent Polypropylene				
195201	150	150	Class B	1 Sign(s) / Pack
Class C Photoluminescent Polypropylene				
139514	150	150	Class C	1 Sign(s) / Pack

IMO322 – 45° DIRECTION ARROW



Order Ref.	Width (mm)	Height (mm)	Class	Total Qty/Pack
Class B Photoluminescent Polyester				
195476	150	150	Class B	1 Sign(s) / Pack
Class C Photoluminescent Polyester				
195180	150	150	Class C	1 Sign(s) / Pack
Class B Photoluminescent Polypropylene				
195202	150	150	Class B	1 Sign(s) / Pack
Class C Photoluminescent Polypropylene				
195137	150	150	Class C	1 Sign(s) / Pack

IMO323 – BOARDING LADDER



Order Ref.	Width (mm)	Height (mm)	Class	Total Qty/Pack
Class B Photoluminescent Polyester				
195477	150	150	Class B	1 Sign(s) / Pack
Class C Photoluminescent Polyester				
195181	150	150	Class C	1 Sign(s) / Pack
Class B Photoluminescent Polypropylene				
195203	150	150	Class B	1 Sign(s) / Pack
Class C Photoluminescent Polypropylene				
195140	150	150	Class C	1 Sign(s) / Pack

IMO324 – FIRST AID



Order Ref.	Width (mm)	Height (mm)	Class	Total Qty/Pack
Class B Photoluminescent Polyester				
195478	150	150	Class B	1 Sign(s) / Pack
Class C Photoluminescent Polyester				
195182	150	150	Class C	1 Sign(s) / Pack
Class B Photoluminescent Polypropylene				
195318	150	150	Class B	1 Sign(s) / Pack
Class C Photoluminescent Polypropylene				
139515	150	150	Class C	1 Sign(s) / Pack

EVACUATION & FIRST AID

IMO325 – EMERGENCY EXIT (RIGHT)



Order Ref.	Width (mm)	Height (mm)	Class	Total Qty/Pack
Class B Photoluminescent Polyester				
195479	150	150	Class B	1 Sign(s) / Pack
Class C Photoluminescent Polyester				
195183	150	150	Class C	1 Sign(s) / Pack
Class B Photoluminescent Polypropylene				
195319	150	150	Class B	1 Sign(s) / Pack
Class C Photoluminescent Polypropylene				
139516	150	150	Class C	1 Sign(s) / Pack

IMO326 – EMERGENCY EXIT (LEFT)



Order Ref.	Width (mm)	Height (mm)	Class	Total Qty/Pack
Class B Photoluminescent Polyester				
195480	150	150	Class B	1 Sign(s) / Pack
Class C Photoluminescent Polyester				
195184	150	150	Class C	1 Sign(s) / Pack
Class B Photoluminescent Polypropylene				
195320	150	150	Class B	1 Sign(s) / Pack
Class C Photoluminescent Polypropylene				
195159	150	150	Class C	1 Sign(s) / Pack

IMO327 – EYE WASH



Order Ref.	Width (mm)	Height (mm)	Class	Total Qty/Pack
Class B Photoluminescent Polyester				
195481	150	150	Class B	1 Sign(s) / Pack
Class C Photoluminescent Polyester				
195185	150	150	Class C	1 Sign(s) / Pack
Class B Photoluminescent Polypropylene				
195321	150	150	Class B	1 Sign(s) / Pack
Class C Photoluminescent Polypropylene				
139517	150	150	Class C	1 Sign(s) / Pack

IMO328 – EMERGENCY STOP BUTTON



Order Ref.	Width (mm)	Height (mm)	Class	Total Qty/Pack
Class B Photoluminescent Polyester				
195482	150	150	Class B	1 Sign(s) / Pack
Class C Photoluminescent Polyester				
195186	150	150	Class C	1 Sign(s) / Pack
Class B Photoluminescent Polypropylene				
195322	150	150	Class B	1 Sign(s) / Pack
Class C Photoluminescent Polypropylene				
139518	150	150	Class C	1 Sign(s) / Pack

IMO329 – EMERGENCY PHONE



Order Ref.	Width (mm)	Height (mm)	Class	Total Qty/Pack
Class B Photoluminescent Polyester				
195483	150	150	Class B	1 Sign(s) / Pack
Class C Photoluminescent Polyester				
195187	150	150	Class C	1 Sign(s) / Pack
Class B Photoluminescent Polypropylene				
195323	150	150	Class B	1 Sign(s) / Pack
Class C Photoluminescent Polypropylene				
139519	150	150	Class C	1 Sign(s) / Pack

IMO330 – EMERGENCY SHOWER

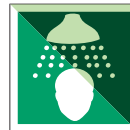

Order Ref.	Width (mm)	Height (mm)	Class	Total Qty/Pack
Class B Photoluminescent Polyester				
195484	150	150	Class B	1 Sign(s) / Pack
Class C Photoluminescent Polyester				
195188	150	150	Class C	1 Sign(s) / Pack
Class B Photoluminescent Polypropylene				
195324	150	150	Class B	1 Sign(s) / Pack
Class C Photoluminescent Polypropylene				
139520	150	150	Class C	1 Sign(s) / Pack

IMO331 – NUMBER 0



Order Ref.	Width (mm)	Height (mm)	Layout	Class	Le-gend	Total Qty/Pack
Class B Photoluminescent Polyester						
195485	75	150	Portrait	Class B	0	1 Sign(s) / Pack
Class C Photoluminescent Polyester						
195189	75	150	Portrait	Class C	0	1 Sign(s) / Pack
Class B Photoluminescent Polypropylene						
195325	75	150	Portrait	Class B	0	1 Sign(s) / Pack
Class C Photoluminescent Polypropylene						
139521	75	150	Portrait	Class C	0	1 Sign(s) / Pack

IMO332 – NUMBER 1



Order Ref.	Width (mm)	Height (mm)	Layout	Class	Le-gend	Total Qty/Pack
Class B Photoluminescent Polyester						
195486	75	150	Portrait	Class B	1	1 Sign(s) / Pack
Class C Photoluminescent Polyester						
195109	75	150	Portrait	Class C	1	1 Sign(s) / Pack
Class B Photoluminescent Polypropylene						
195326	75	150	Portrait	Class B	1	1 Sign(s) / Pack
Class C Photoluminescent Polypropylene						
139522	75	150	Portrait	Class C	1	1 Sign(s) / Pack

IMO333 – NUMBER 2



Order Ref.	Width (mm)	Height (mm)	Layout	Class	Le-gend	Total Qty/Pack
Class B Photoluminescent Polyester						
195487	75	150	Portrait	Class B	2	1 Sign(s) / Pack
Class C Photoluminescent Polyester						
195110	75	150	Portrait	Class C	2	1 Sign(s) / Pack
Class B Photoluminescent Polypropylene						
195327	75	150	Portrait	Class B	2	1 Sign(s) / Pack
Class C Photoluminescent Polypropylene						
139523	75	150	Portrait	Class C	2	1 Sign(s) / Pack

IMO334 – NUMBER 3



Order Ref.	Width (mm)	Height (mm)	Layout	Class	Le-gend	Total Qty/Pack
Class B Photoluminescent Polyester						
195488	75	150	Portrait	Class B	3	1 Sign(s) / Pack
Class C Photoluminescent Polyester						
195111	75	150	Portrait	Class C	3	1 Sign(s) / Pack
Class B Photoluminescent Polypropylene						
195328	75	150	Portrait	Class B	3	1 Sign(s) / Pack
Class C Photoluminescent Polypropylene						
139524	75	150	Portrait	Class C	3	1 Sign(s) / Pack

IMO335 – NUMBER 4



Order Ref.	Width (mm)	Height (mm)	Layout	Class	Le-gend	Total Qty/Pack
Class B Photoluminescent Polyester						
195489	75	150	Portrait	Class B	4	1 Sign(s) / Pack
Class C Photoluminescent Polyester						
195112	75	150	Portrait	Class C	4	1 Sign(s) / Pack
Class B Photoluminescent Polypropylene						
195329	75	150	Portrait	Class B	4	1 Sign(s) / Pack
Class C Photoluminescent Polypropylene						
139525	75	150	Portrait	Class C	4	1 Sign(s) / Pack

IMO336 – NUMBER 5



Order Ref.	Width (mm)	Height (mm)	Layout	Class	Le-gend	Total Qty/Pack
Class B Photoluminescent Polyester						
195490	75	150	Portrait	Class B	5	1 Sign(s) / Pack
Class C Photoluminescent Polyester						
195113	75	150	Portrait	Class C	5	1 Sign(s) / Pack
Class B Photoluminescent Polypropylene						
195330	75	150	Portrait	Class B	5	1 Sign(s) / Pack
Class C Photoluminescent Polypropylene						
139526	75	150	Portrait	Class C	5	1 Sign(s) / Pack

EVACUATION & FIRST AID

IM0337 – NUMBER 6



Order Ref.	Width (mm)	Height (mm)	Layout	Class	Le-gend	Total Qty/Pack
Class B Photoluminescent Polyester						
195491	75	150	Portrait	Class B	6	1 Sign(s) / Pack
Class C Photoluminescent Polyester						
195114	75	150	Portrait	Class C	6	1 Sign(s) / Pack
Class B Photoluminescent Polypropylene						
195331	75	150	Portrait	Class B	6	1 Sign(s) / Pack
Class C Photoluminescent Polypropylene						
139527	75	150	Portrait	Class C	6	1 Sign(s) / Pack

IM0339 – NUMBER 8



Order Ref.	Width (mm)	Height (mm)	Layout	Class	Le-gend	Total Qty/Pack
Class B Photoluminescent Polyester						
195493	75	150	Portrait	Class B	8	1 Sign(s) / Pack
Class C Photoluminescent Polyester						
195116	75	150	Portrait	Class C	8	1 Sign(s) / Pack
Class B Photoluminescent Polypropylene						
195333	75	150	Portrait	Class B	8	1 Sign(s) / Pack
Class C Photoluminescent Polypropylene						
139529	75	150	Portrait	Class C	8	1 Sign(s) / Pack

IM0341 – DRINKING WATER



Order Ref.	Width (mm)	Height (mm)	Class	Total Qty/Pack
Class B Photoluminescent Polyester				
195495	150	150	Class B	1 Sign(s) / Pack
Class C Photoluminescent Polyester				
195118	150	150	Class C	1 Sign(s) / Pack
Class B Photoluminescent Polypropylene				
195335	150	150	Class B	1 Sign(s) / Pack
Class C Photoluminescent Polypropylene				
139531	150	150	Class C	1 Sign(s) / Pack

IM0343 – STAIRS



Order Ref.	Width (mm)	Height (mm)	Class	Total Qty/Pack
Class B Photoluminescent Polyester				
195497	150	150	Class B	1 Sign(s) / Pack
Class C Photoluminescent Polyester				
195120	150	150	Class C	1 Sign(s) / Pack
Class B Photoluminescent Polypropylene				
195337	150	150	Class B	1 Sign(s) / Pack
Class C Photoluminescent Polypropylene				
194990	150	150	Class C	1 Sign(s) / Pack

IM0345 – THERMAL PROTECTION SUIT



Order Ref.	Width (mm)	Height (mm)	Class	Legend	Total Qty/Pack
Class B Photoluminescent Polyester					
195499	150	150	Class B	AES	1 Sign(s) / Pack
Class C Photoluminescent Polyester					
195122	150	150	Class C	AES	1 Sign(s) / Pack
Class B Photoluminescent Polypropylene					
195339	150	150	Class B	AES	1 Sign(s) / Pack
Class C Photoluminescent Polypropylene					
194992	150	150	Class C	AES	1 Sign(s) / Pack

IM0351 – EXIT



Order Ref.	Width (mm)	Height (mm)	Layout	Class	Legend	Total Qty/Pack
Class B Photoluminescent Polyester						
195501	300	150	Landscape	Class B	EXIT	1 Sign(s) / Pack
Class C Photoluminescent Polyester						
195124	300	150	Landscape	Class C	EXIT	1 Sign(s) / Pack
Class B Photoluminescent Polypropylene						
195341	300	150	Landscape	Class B	EXIT	1 Sign(s) / Pack
Class C Photoluminescent Polypropylene						
194994	300	150	Landscape	Class C	EXIT	1 Sign(s) / Pack

IM0353 – CATERING AREA



Order Ref.	Width (mm)	Height (mm)	Layout	Class	Legend	Total Qty/Pack
Class B Photoluminescent Polyester						
195503	300	150	Landscape	Class B	EATING AND DRINKING AREA	1 Sign(s) / Pack
Class C Photoluminescent Polyester						
195126	300	150	Landscape	Class C	EATING AND DRINKING AREA	1 Sign(s) / Pack
Class B Photoluminescent Polypropylene						
195343	300	150	Landscape	Class B	EATING AND DRINKING AREA	1 Sign(s) / Pack
Class C Photoluminescent Polypropylene						
194996	300	150	Landscape	Class C	EATING AND DRINKING AREA	1 Sign(s) / Pack

IM0338 – NUMBER 7



Order Ref.	Width (mm)	Height (mm)	Layout	Class	Le-gend	Total Qty/Pack
Class B Photoluminescent Polyester						
195492	75	150	Portrait	Class B	7	1 Sign(s) / Pack
Class C Photoluminescent Polyester						
195115	75	150	Portrait	Class C	7	1 Sign(s) / Pack
Class B Photoluminescent Polypropylene						
195332	75	150	Portrait	Class B	7	1 Sign(s) / Pack
Class C Photoluminescent Polypropylene						
139528	75	150	Portrait	Class C	7	1 Sign(s) / Pack

IM0340 – NUMBER 9



Order Ref.	Width (mm)	Height (mm)	Layout	Class	Le-gend	Total Qty/Pack
Class B Photoluminescent Polyester						
195494	75	150	Portrait	Class B	9	1 Sign(s) / Pack
Class C Photoluminescent Polyester						
195117	75	150	Portrait	Class C	9	1 Sign(s) / Pack
Class B Photoluminescent Polypropylene						
195334	75	150	Portrait	Class B	9	1 Sign(s) / Pack
Class C Photoluminescent Polypropylene						
139530	75	150	Portrait	Class C	9	1 Sign(s) / Pack

IM0342 – AUTHORISATION OF...



Order Ref.	Width (mm)	Height (mm)	Class	Total Qty/Pack
Class B Photoluminescent Polyester				
195496	150	150	Class B	1 Sign(s) / Pack
Class C Photoluminescent Polyester				
195119	150	150	Class C	1 Sign(s) / Pack
Class B Photoluminescent Polypropylene				
195336	150	150	Class B	1 Sign(s) / Pack
Class C Photoluminescent Polypropylene				
194989	150	150	Class C	1 Sign(s) / Pack

IM0344 – THERMAL PROTECTION COVER



Order Ref.	Width (mm)	Height (mm)	Class	Legend	Total Qty/Pack
Class B Photoluminescent Polyester					
195498	150	150	Class B	TPA	1 Sign(s) / Pack
Class C Photoluminescent Polyester					
195121	150	150	Class C	TPA	1 Sign(s) / Pack
Class B Photoluminescent Polypropylene					
195338	150	150	Class B	TPA	1 Sign(s) / Pack
Class C Photoluminescent Polypropylene					
194991	150	150	Class C	TPA	1 Sign(s) / Pack

IM0352 – SMOKING AREA



Order Ref.	Width (mm)	Height (mm)	Layout	Class	Legend	Total Qty/Pack
Class B Photoluminescent Polyester						
195502	300	150	Landscape	Class B	SMOKING AREA	1 Sign(s) / Pack
Class C Photoluminescent Polyester						
195125	300	150	Landscape	Class C	SMOKING AREA	1 Sign(s) / Pack
Class B Photoluminescent Polypropylene						
195342	300	150	Landscape	Class B	SMOKING AREA	1 Sign(s) / Pack
Class C Photoluminescent Polypropylene						
194995	300	150	Landscape	Class C	SMOKING AREA	1 Sign(s) / Pack

Compliant with ISO 24409 standard

FIRE SAFETY

IMO101 – FIRE PROTECTION PLAN



Order Ref.	Width (mm)	Height (mm)	Class	Total Qty/Pack
Class B Photoluminescent Polyester				
195359	150	150	Class B	1 Sign(s) / Pack
Class C Photoluminescent Polyester				
195012	150	150	Class C	1 Sign(s) / Pack
Class B Photoluminescent Polypropylene				
195206	150	150	Class B	1 Sign(s) / Pack
Class C Photoluminescent Polypropylene				
139416	150	150	Class C	1 Sign(s) / Pack

IMO102 – FIRE ALARM BUTTON/SWITCH

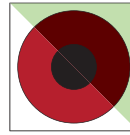

Order Ref.	Width (mm)	Height (mm)	Class	Total Qty/Pack
Class B Photoluminescent Polyester				
195360	150	150	Class B	1 Sign(s) / Pack
Class C Photoluminescent Polyester				
195013	150	150	Class C	1 Sign(s) / Pack
Class B Photoluminescent Polypropylene				
195207	150	150	Class B	1 Sign(s) / Pack
Class C Photoluminescent Polypropylene				
139417	150	150	Class C	1 Sign(s) / Pack

IMO103 – FIRE ALARM HORN

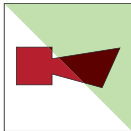

Order Ref.	Width (mm)	Height (mm)	Class	Total Qty/Pack
Class B Photoluminescent Polyester				
195361	150	150	Class B	1 Sign(s) / Pack
Class C Photoluminescent Polyester				
195014	150	150	Class C	1 Sign(s) / Pack
Class B Photoluminescent Polypropylene				
195208	150	150	Class B	1 Sign(s) / Pack
Class C Photoluminescent Polypropylene				
139418	150	150	Class C	1 Sign(s) / Pack

IMO104 – FIRE ALARM POST

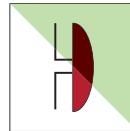

Order Ref.	Width (mm)	Height (mm)	Class	Total Qty/Pack
Class B Photoluminescent Polyester				
195362	150	150	Class B	1 Sign(s) / Pack
Class C Photoluminescent Polyester				
195015	150	150	Class C	1 Sign(s) / Pack
Class B Photoluminescent Polypropylene				
195209	150	150	Class B	1 Sign(s) / Pack
Class C Photoluminescent Polypropylene				
139419	150	150	Class C	1 Sign(s) / Pack

IMO105 – MANUAL ACTIVATION STATION

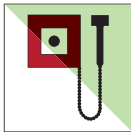

Order Ref.	Width (mm)	Height (mm)	Class	Total Qty/Pack
Class B Photoluminescent Polyester				
195363	150	150	Class B	1 Sign(s) / Pack
Class C Photoluminescent Polyester				
195016	150	150	Class C	1 Sign(s) / Pack
Class B Photoluminescent Polypropylene				
195210	150	150	Class B	1 Sign(s) / Pack
Class C Photoluminescent Polypropylene				
139420	150	150	Class C	1 Sign(s) / Pack

IMO106 – SPACE PROTECTED BY AUTOMATIC FIRE ALARM

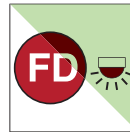

Order Ref.	Width (mm)	Height (mm)	Class	Total Qty/Pack
Class B Photoluminescent Polyester				
195364	150	150	Class B	1 Sign(s) / Pack
Class C Photoluminescent Polyester				
195017	150	150	Class C	1 Sign(s) / Pack
Class B Photoluminescent Polypropylene				
195211	150	150	Class B	1 Sign(s) / Pack
Class C Photoluminescent Polypropylene				
139421	150	150	Class C	1 Sign(s) / Pack

IMO107 – SPACE PROTECTED BY CO2

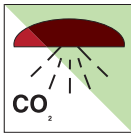

Order Ref.	Width (mm)	Height (mm)	Class	Total Qty/Pack
Class B Photoluminescent Polyester				
195365	150	150	Class B	1 Sign(s) / Pack
Class C Photoluminescent Polyester				
195018	150	150	Class C	1 Sign(s) / Pack
Class B Photoluminescent Polypropylene				
195212	150	150	Class B	1 Sign(s) / Pack
Class C Photoluminescent Polypropylene				
139422	150	150	Class C	1 Sign(s) / Pack

IMO108 – CO2 HORN

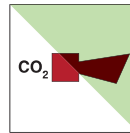

Order Ref.	Width (mm)	Height (mm)	Class	Total Qty/Pack
Class B Photoluminescent Polyester				
195366	150	150	Class B	1 Sign(s) / Pack
Class C Photoluminescent Polyester				
195019	150	150	Class C	1 Sign(s) / Pack
Class B Photoluminescent Polypropylene				
195213	150	150	Class B	1 Sign(s) / Pack
Class C Photoluminescent Polypropylene				
139423	150	150	Class C	1 Sign(s) / Pack

IMO109 – CO2 TRIGGER STATION

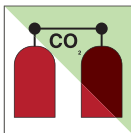

Order Ref.	Width (mm)	Height (mm)	Class	Total Qty/Pack
Class B Photoluminescent Polyester				
195367	150	150	Class B	1 Sign(s) / Pack
Class C Photoluminescent Polyester				
195020	150	150	Class C	1 Sign(s) / Pack
Class B Photoluminescent Polypropylene				
195214	150	150	Class B	1 Sign(s) / Pack
Class C Photoluminescent Polypropylene				
139424	150	150	Class C	1 Sign(s) / Pack

IMO110 – BOTTLES OF HALON 1301



Order Ref.	Width (mm)	Height (mm)	Class	Total Qty/Pack
Class B Photoluminescent Polyester				
195368	150	150	Class B	1 Sign(s) / Pack
Class C Photoluminescent Polyester				
195021	150	150	Class C	1 Sign(s) / Pack
Class B Photoluminescent Polypropylene				
195215	150	150	Class B	1 Sign(s) / Pack
Class C Photoluminescent Polypropylene				
139425	150	150	Class C	1 Sign(s) / Pack

IMO111 – AREA PROTECTED WITH HALON 1301



Order Ref.	Width (mm)	Height (mm)	Class	Total Qty/Pack
Class B Photoluminescent Polyester				
195369	150	150	Class B	1 Sign(s) / Pack
Class C Photoluminescent Polyester				
195022	150	150	Class C	1 Sign(s) / Pack
Class B Photoluminescent Polypropylene				
195216	150	150	Class B	1 Sign(s) / Pack
Class C Photoluminescent Polypropylene				
139426	150	150	Class C	1 Sign(s) / Pack

IMO112 – HALON HORN

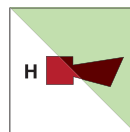

Order Ref.	Width (mm)	Height (mm)	Class	Total Qty/Pack
Class B Photoluminescent Polyester				
195370	150	150	Class B	1 Sign(s) / Pack
Class C Photoluminescent Polyester				
195023	150	150	Class C	1 Sign(s) / Pack
Class B Photoluminescent Polypropylene				
195217	150	150	Class B	1 Sign(s) / Pack
Class C Photoluminescent Polypropylene				
139427	150	150	Class C	1 Sign(s) / Pack

FIRE SAFETY

IMO113 – MOUSSE EXTINGUISHER SYSTEM

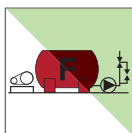

Order Ref.	Width (mm)	Height (mm)	Class	Total Qty/Pack
Class B Photoluminescent Polyester				
195371	150	150	Class B	1 Sign(s) / Pack
Class C Photoluminescent Polyester				
195024	150	150	Class C	1 Sign(s) / Pack
Class B Photoluminescent Polypropylene				
195218	150	150	Class B	1 Sign(s) / Pack
Class C Photoluminescent Polypropylene				
139428	150	150	Class C	1 Sign(s) / Pack

IMO114 – FOAM GUN

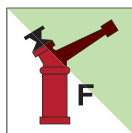

Order Ref.	Width (mm)	Height (mm)	Class	Total Qty/Pack
Class B Photoluminescent Polyester				
195372	150	150	Class B	1 Sign(s) / Pack
Class C Photoluminescent Polyester				
195025	150	150	Class C	1 Sign(s) / Pack
Class B Photoluminescent Polypropylene				
195219	150	150	Class B	1 Sign(s) / Pack
Class C Photoluminescent Polypropylene				
139429	150	150	Class C	1 Sign(s) / Pack

IMO115 – FOAM HOSE

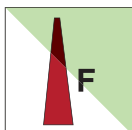

Order Ref.	Width (mm)	Height (mm)	Class	Total Qty/Pack
Class B Photoluminescent Polyester				
195373	150	150	Class B	1 Sign(s) / Pack
Class C Photoluminescent Polyester				
195026	150	150	Class C	1 Sign(s) / Pack
Class B Photoluminescent Polypropylene				
195220	150	150	Class B	1 Sign(s) / Pack
Class C Photoluminescent Polypropylene				
139430	150	150	Class C	1 Sign(s) / Pack

IMO116 – DEVICE FOR APPLYING FOAM

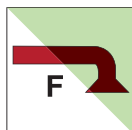

Order Ref.	Width (mm)	Height (mm)	Class	Total Qty/Pack
Class B Photoluminescent Polyester				
195374	150	150	Class B	1 Sign(s) / Pack
Class C Photoluminescent Polyester				
195027	150	150	Class C	1 Sign(s) / Pack
Class B Photoluminescent Polypropylene				
195221	150	150	Class B	1 Sign(s) / Pack
Class C Photoluminescent Polypropylene				
139431	150	150	Class C	1 Sign(s) / Pack

IMO117 – FOAM CIRCUIT VALVE

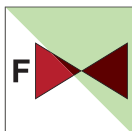

Order Ref.	Width (mm)	Height (mm)	Class	Total Qty/Pack
Class B Photoluminescent Polyester				
195375	150	150	Class B	1 Sign(s) / Pack
Class C Photoluminescent Polyester				
195028	150	150	Class C	1 Sign(s) / Pack
Class B Photoluminescent Polypropylene				
195222	150	150	Class B	1 Sign(s) / Pack
Class C Photoluminescent Polypropylene				
139432	150	150	Class C	1 Sign(s) / Pack

IMO118 – MOUSSE TRIGGER POST

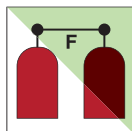

Order Ref.	Width (mm)	Height (mm)	Class	Total Qty/Pack
Class B Photoluminescent Polyester				
195376	150	150	Class B	1 Sign(s) / Pack
Class C Photoluminescent Polyester				
195029	150	150	Class C	1 Sign(s) / Pack
Class B Photoluminescent Polypropylene				
195223	150	150	Class B	1 Sign(s) / Pack
Class C Photoluminescent Polypropylene				
139433	150	150	Class C	1 Sign(s) / Pack

IMO119 – EMERGENCY FIRE-PUMP

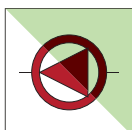

Order Ref.	Width (mm)	Height (mm)	Class	Total Qty/Pack
Class B Photoluminescent Polyester				
195377	150	150	Class B	1 Sign(s) / Pack
Class C Photoluminescent Polyester				
195030	150	150	Class C	1 Sign(s) / Pack
Class B Photoluminescent Polypropylene				
195224	150	150	Class B	1 Sign(s) / Pack
Class C Photoluminescent Polypropylene				
139434	150	150	Class C	1 Sign(s) / Pack

IMO120 – REMOTE CONTROLLED FIRE PUMPS

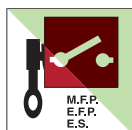

Order Ref.	Width (mm)	Height (mm)	Class	Total Qty/Pack
Class B Photoluminescent Polyester				
195378	150	150	Class B	1 Sign(s) / Pack
Class C Photoluminescent Polyester				
195031	150	150	Class C	1 Sign(s) / Pack
Class B Photoluminescent Polypropylene				
195225	150	150	Class B	1 Sign(s) / Pack
Class C Photoluminescent Polypropylene				
139435	150	150	Class C	1 Sign(s) / Pack

IMO121 – BILGE PUMP

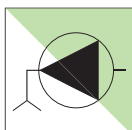

Order Ref.	Width (mm)	Height (mm)	Class	Total Qty/Pack
Class B Photoluminescent Polyester				
195379	150	150	Class B	1 Sign(s) / Pack
Class C Photoluminescent Polyester				
195032	150	150	Class C	1 Sign(s) / Pack
Class B Photoluminescent Polypropylene				
195226	150	150	Class B	1 Sign(s) / Pack
Class C Photoluminescent Polypropylene				
139436	150	150	Class C	1 Sign(s) / Pack

IMO122 – STANDBY BILGE PUMP

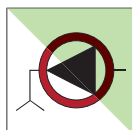

Order Ref.	Width (mm)	Height (mm)	Class	Total Qty/Pack
Class B Photoluminescent Polyester				
195380	150	150	Class B	1 Sign(s) / Pack
Class C Photoluminescent Polyester				
195033	150	150	Class C	1 Sign(s) / Pack
Class B Photoluminescent Polypropylene				
195227	150	150	Class B	1 Sign(s) / Pack
Class C Photoluminescent Polypropylene				
139437	150	150	Class C	1 Sign(s) / Pack

IMO123 – WATER CANNON

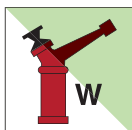

Order Ref.	Width (mm)	Height (mm)	Class	Total Qty/Pack
Class B Photoluminescent Polyester				
195381	150	150	Class B	1 Sign(s) / Pack
Class C Photoluminescent Polyester				
195034	150	150	Class C	1 Sign(s) / Pack
Class B Photoluminescent Polypropylene				
195228	150	150	Class B	1 Sign(s) / Pack
Class C Photoluminescent Polypropylene				
139438	150	150	Class C	1 Sign(s) / Pack

IMO124 – WATER SPRAY FIRE-EXTINGUISHER SYSTEM

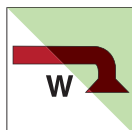

Order Ref.	Width (mm)	Height (mm)	Class	Total Qty/Pack
Class B Photoluminescent Polyester				
195382	150	150	Class B	1 Sign(s) / Pack
Class C Photoluminescent Polyester				
195035	150	150	Class C	1 Sign(s) / Pack
Class B Photoluminescent Polypropylene				
195229	150	150	Class B	1 Sign(s) / Pack
Class C Photoluminescent Polypropylene				
139439	150	150	Class C	1 Sign(s) / Pack

FIRE SAFETY

IM0125 – EMERGENCY PHONE STATION



Order Ref.	Width (mm)	Height (mm)	Class	Total Qty/Pack
Class B Photoluminescent Polyester				
195383	150	150	Class B	1 Sign(s) / Pack
Class C Photoluminescent Polyester				
195036	150	150	Class C	1 Sign(s) / Pack
Class B Photoluminescent Polypropylene				
195230	150	150	Class B	1 Sign(s) / Pack
Class C Photoluminescent Polypropylene				
139440	150	150	Class C	1 Sign(s) / Pack

IM0126 – FIRE AXE

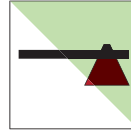

Order Ref.	Width (mm)	Height (mm)	Class	Total Qty/Pack
Class B Photoluminescent Polyester				
195384	150	150	Class B	1 Sign(s) / Pack
Class C Photoluminescent Polyester				
195037	150	150	Class C	1 Sign(s) / Pack
Class B Photoluminescent Polypropylene				
195231	150	150	Class B	1 Sign(s) / Pack
Class C Photoluminescent Polypropylene				
139441	150	150	Class C	1 Sign(s) / Pack

IM0127 – DELUGE SYSTEM

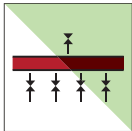

Order Ref.	Width (mm)	Height (mm)	Class	Total Qty/Pack
Class B Photoluminescent Polyester				
195385	150	150	Class B	1 Sign(s) / Pack
Class C Photoluminescent Polyester				
195038	150	150	Class C	1 Sign(s) / Pack
Class B Photoluminescent Polypropylene				
195232	150	150	Class B	1 Sign(s) / Pack
Class C Photoluminescent Polypropylene				
139442	150	150	Class C	1 Sign(s) / Pack

IM0128 – SPACE PROTECTED BY DELUGE SYSTEM

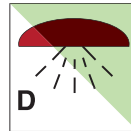

Order Ref.	Width (mm)	Height (mm)	Class	Total Qty/Pack
Class B Photoluminescent Polyester				
195386	150	150	Class B	1 Sign(s) / Pack
Class C Photoluminescent Polyester				
195039	150	150	Class C	1 Sign(s) / Pack
Class B Photoluminescent Polypropylene				
195233	150	150	Class B	1 Sign(s) / Pack
Class C Photoluminescent Polypropylene				
139443	150	150	Class C	1 Sign(s) / Pack

IM0129 – BLOCK VALVES OF THE DELUGE SYSTEM

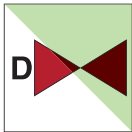

Order Ref.	Width (mm)	Height (mm)	Class	Total Qty/Pack
Class B Photoluminescent Polyester				
195387	150	150	Class B	1 Sign(s) / Pack
Class C Photoluminescent Polyester				
195040	150	150	Class C	1 Sign(s) / Pack
Class B Photoluminescent Polypropylene				
195234	150	150	Class B	1 Sign(s) / Pack
Class C Photoluminescent Polypropylene				
139444	150	150	Class C	1 Sign(s) / Pack

IM0130 – FIRE HALL



Order Ref.	Width (mm)	Height (mm)	Class	Total Qty/Pack
Class B Photoluminescent Polyester				
195388	150	150	Class B	1 Sign(s) / Pack
Class C Photoluminescent Polyester				
195041	150	150	Class C	1 Sign(s) / Pack
Class B Photoluminescent Polypropylene				
195235	150	150	Class B	1 Sign(s) / Pack
Class C Photoluminescent Polypropylene				
139445	150	150	Class C	1 Sign(s) / Pack

IM0131 – CLASS A PARTITION

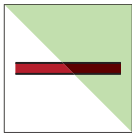

Order Ref.	Width (mm)	Height (mm)	Class	Total Qty/Pack
Class B Photoluminescent Polyester				
195389	150	150	Class B	1 Sign(s) / Pack
Class C Photoluminescent Polyester				
195042	150	150	Class C	1 Sign(s) / Pack
Class B Photoluminescent Polypropylene				
195236	150	150	Class B	1 Sign(s) / Pack
Class C Photoluminescent Polypropylene				
139446	150	150	Class C	1 Sign(s) / Pack

IM0132 – CLASS A FIRE DOOR

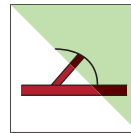

Order Ref.	Width (mm)	Height (mm)	Class	Total Qty/Pack
Class B Photoluminescent Polyester				
195390	150	150	Class B	1 Sign(s) / Pack
Class C Photoluminescent Polyester				
195043	150	150	Class C	1 Sign(s) / Pack
Class B Photoluminescent Polypropylene				
195237	150	150	Class B	1 Sign(s) / Pack
Class C Photoluminescent Polypropylene				
139447	150	150	Class C	1 Sign(s) / Pack

IM0133 – CLASS A AUTOMATIC FIRE DOOR

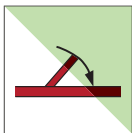

Order Ref.	Width (mm)	Height (mm)	Class	Total Qty/Pack
Class B Photoluminescent Polyester				
195391	150	150	Class B	1 Sign(s) / Pack
Class C Photoluminescent Polyester				
195044	150	150	Class C	1 Sign(s) / Pack
Class B Photoluminescent Polypropylene				
195238	150	150	Class B	1 Sign(s) / Pack
Class C Photoluminescent Polypropylene				
139448	150	150	Class C	1 Sign(s) / Pack

IM0134 – CLASS A FIRE DOOR

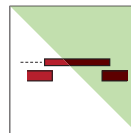

Order Ref.	Width (mm)	Height (mm)	Class	Total Qty/Pack
Class B Photoluminescent Polyester				
195392	150	150	Class B	1 Sign(s) / Pack
Class C Photoluminescent Polyester				
195045	150	150	Class C	1 Sign(s) / Pack
Class B Photoluminescent Polypropylene				
195239	150	150	Class B	1 Sign(s) / Pack
Class C Photoluminescent Polypropylene				
139449	150	150	Class C	1 Sign(s) / Pack

IM0135 – CLASS A AUTOMATIC FIRE DOOR

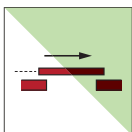

Order Ref.	Width (mm)	Height (mm)	Class	Total Qty/Pack
Class B Photoluminescent Polyester				
195393	150	150	Class B	1 Sign(s) / Pack
Class C Photoluminescent Polyester				
195046	150	150	Class C	1 Sign(s) / Pack
Class B Photoluminescent Polypropylene				
195240	150	150	Class B	1 Sign(s) / Pack
Class C Photoluminescent Polypropylene				
139450	150	150	Class C	1 Sign(s) / Pack

IM0136 – PORTABLE DEVICE FOR APPLYING FOAM

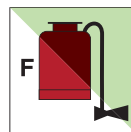

Order Ref.	Width (mm)	Height (mm)	Class	Total Qty/Pack
Class B Photoluminescent Polyester				
195394	150	150	Class B	1 Sign(s) / Pack
Class C Photoluminescent Polyester				
195047	150	150	Class C	1 Sign(s) / Pack
Class B Photoluminescent Polypropylene				
195241	150	150	Class B	1 Sign(s) / Pack
Class C Photoluminescent Polypropylene				
139451	150	150	Class C	1 Sign(s) / Pack

FIRE SAFETY

IMO137 – CLASS B PARTITION

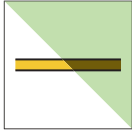

Order Ref.	Width (mm)	Height (mm)	Class	Total Qty/Pack
Class B Photoluminescent Polyester				
195395	150	150	Class B	1 Sign(s) / Pack
Class C Photoluminescent Polyester				
195048	150	150	Class C	1 Sign(s) / Pack
Class B Photoluminescent Polypropylene				
195242	150	150	Class B	1 Sign(s) / Pack
Class C Photoluminescent Polypropylene				
139452	150	150	Class C	1 Sign(s) / Pack

IMO138 – CLASS B FIRE DOOR

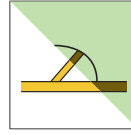

Order Ref.	Width (mm)	Height (mm)	Class	Total Qty/Pack
Class B Photoluminescent Polyester				
195396	150	150	Class B	1 Sign(s) / Pack
Class C Photoluminescent Polyester				
195049	150	150	Class C	1 Sign(s) / Pack
Class B Photoluminescent Polypropylene				
195243	150	150	Class B	1 Sign(s) / Pack
Class C Photoluminescent Polypropylene				
139453	150	150	Class C	1 Sign(s) / Pack

IMO139 – CLASS B AUTOMATIC FIRE DOOR

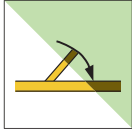

Order Ref.	Width (mm)	Height (mm)	Class	Total Qty/Pack
Class B Photoluminescent Polyester				
195397	150	150	Class B	1 Sign(s) / Pack
Class C Photoluminescent Polyester				
195050	150	150	Class C	1 Sign(s) / Pack
Class B Photoluminescent Polypropylene				
195244	150	150	Class B	1 Sign(s) / Pack
Class C Photoluminescent Polypropylene				
139454	150	150	Class C	1 Sign(s) / Pack

IMO140 – CLASS B FIRE DOOR

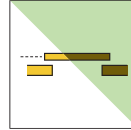

Order Ref.	Width (mm)	Height (mm)	Class	Total Qty/Pack
Class B Photoluminescent Polyester				
195398	150	150	Class B	1 Sign(s) / Pack
Class C Photoluminescent Polyester				
195051	150	150	Class C	1 Sign(s) / Pack
Class B Photoluminescent Polypropylene				
195245	150	150	Class B	1 Sign(s) / Pack
Class C Photoluminescent Polypropylene				
139455	150	150	Class C	1 Sign(s) / Pack

IMO141 – CLASS B AUTOMATIC FIRE DOOR

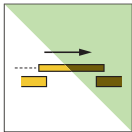

Order Ref.	Width (mm)	Height (mm)	Class	Total Qty/Pack
Class B Photoluminescent Polyester				
195399	150	150	Class B	1 Sign(s) / Pack
Class C Photoluminescent Polyester				
195052	150	150	Class C	1 Sign(s) / Pack
Class B Photoluminescent Polypropylene				
195246	150	150	Class B	1 Sign(s) / Pack
Class C Photoluminescent Polypropylene				
139456	150	150	Class C	1 Sign(s) / Pack

IMO142 – MAIN VERTICAL AREA

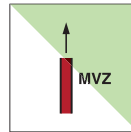

Order Ref.	Width (mm)	Height (mm)	Class	Total Qty/Pack
Class B Photoluminescent Polyester				
195400	150	150	Class B	1 Sign(s) / Pack
Class C Photoluminescent Polyester				
195053	150	150	Class C	1 Sign(s) / Pack
Class B Photoluminescent Polypropylene				
195247	150	150	Class B	1 Sign(s) / Pack
Class C Photoluminescent Polypropylene				
139457	150	150	Class C	1 Sign(s) / Pack

IMO143 – FIRE ALARM PANEL

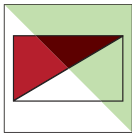

Order Ref.	Width (mm)	Height (mm)	Class	Total Qty/Pack
Class B Photoluminescent Polyester				
195401	150	150	Class B	1 Sign(s) / Pack
Class C Photoluminescent Polyester				
195054	150	150	Class C	1 Sign(s) / Pack
Class B Photoluminescent Polypropylene				
195248	150	150	Class B	1 Sign(s) / Pack
Class C Photoluminescent Polypropylene				
139458	150	150	Class C	1 Sign(s) / Pack

IMO144 – SPRINKLER SYSTEM

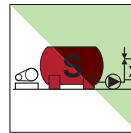

Order Ref.	Width (mm)	Height (mm)	Class	Total Qty/Pack
Class B Photoluminescent Polyester				
195402	150	150	Class B	1 Sign(s) / Pack
Class C Photoluminescent Polyester				
195055	150	150	Class C	1 Sign(s) / Pack
Class B Photoluminescent Polypropylene				
195249	150	150	Class B	1 Sign(s) / Pack
Class C Photoluminescent Polypropylene				
139459	150	150	Class C	1 Sign(s) / Pack

IMO145 – AUTOMATIC EXTINGUISHER



Order Ref.	Width (mm)	Height (mm)	Class	Total Qty/Pack
Class B Photoluminescent Polyester				
195403	150	150	Class B	1 Sign(s) / Pack
Class C Photoluminescent Polyester				
195056	150	150	Class C	1 Sign(s) / Pack
Class B Photoluminescent Polypropylene				
195250	150	150	Class B	1 Sign(s) / Pack
Class C Photoluminescent Polypropylene				
139460	150	150	Class C	1 Sign(s) / Pack

IMO146 – SPRINKLER HORN

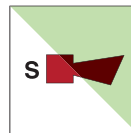

Order Ref.	Width (mm)	Height (mm)	Class	Total Qty/Pack
Class B Photoluminescent Polyester				
195404	150	150	Class B	1 Sign(s) / Pack
Class C Photoluminescent Polyester				
195057	150	150	Class C	1 Sign(s) / Pack
Class B Photoluminescent Polypropylene				
195251	150	150	Class B	1 Sign(s) / Pack
Class C Photoluminescent Polypropylene				
139461	150	150	Class C	1 Sign(s) / Pack

IMO147 – SPRINKLER BLOCK VALVES

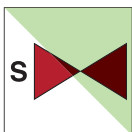

Order Ref.	Width (mm)	Height (mm)	Class	Total Qty/Pack
Class B Photoluminescent Polyester				
195405	150	150	Class B	1 Sign(s) / Pack
Class C Photoluminescent Polyester				
195058	150	150	Class C	1 Sign(s) / Pack
Class B Photoluminescent Polypropylene				
195252	150	150	Class B	1 Sign(s) / Pack
Class C Photoluminescent Polypropylene				
139462	150	150	Class C	1 Sign(s) / Pack

IMO148 – BOTTLES OF CO2

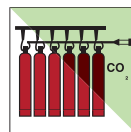

Order Ref.	Width (mm)	Height (mm)	Class	Total Qty/Pack
Class B Photoluminescent Polyester				
195406	150	150	Class B	1 Sign(s) / Pack
Class C Photoluminescent Polyester				
195059	150	150	Class C	1 Sign(s) / Pack
Class B Photoluminescent Polypropylene				
195253	150	150	Class B	1 Sign(s) / Pack
Class C Photoluminescent Polypropylene				
139463	150	150	Class C	1 Sign(s) / Pack

FIRE SAFETY

IMO149 – HALON TRIGGER STATION

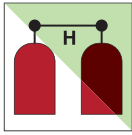

Order Ref.	Width (mm)	Height (mm)	Class	Total Qty/Pack
Class B Photoluminescent Polyester				
195407	150	150	Class B	1 Sign(s) / Pack
Class C Photoluminescent Polyester				
195060	150	150	Class C	1 Sign(s) / Pack
Class B Photoluminescent Polypropylene				
195254	150	150	Class B	1 Sign(s) / Pack
Class C Photoluminescent Polypropylene				
139464	150	150	Class C	1 Sign(s) / Pack

IMO150 – BOTTLES OF HALON 1301 STORED IN A PROTECTED AREA

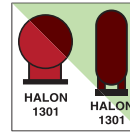

Order Ref.	Width (mm)	Height (mm)	Class	Total Qty/Pack
Class B Photoluminescent Polyester				
195408	150	150	Class B	1 Sign(s) / Pack
Class C Photoluminescent Polyester				
195061	150	150	Class C	1 Sign(s) / Pack
Class B Photoluminescent Polypropylene				
195255	150	150	Class B	1 Sign(s) / Pack
Class C Photoluminescent Polypropylene				
139465	150	150	Class C	1 Sign(s) / Pack

IMO151 – POWDER EXTINGUISHER SYSTEM

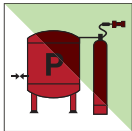

Order Ref.	Width (mm)	Height (mm)	Class	Total Qty/Pack
Class B Photoluminescent Polyester				
195409	150	150	Class B	1 Sign(s) / Pack
Class C Photoluminescent Polyester				
195062	150	150	Class C	1 Sign(s) / Pack
Class B Photoluminescent Polypropylene				
195256	150	150	Class B	1 Sign(s) / Pack
Class C Photoluminescent Polypropylene				
139466	150	150	Class C	1 Sign(s) / Pack

IMO152 – POWDER CANNON

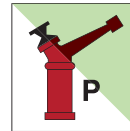

Order Ref.	Width (mm)	Height (mm)	Class	Total Qty/Pack
Class B Photoluminescent Polyester				
195410	150	150	Class B	1 Sign(s) / Pack
Class C Photoluminescent Polyester				
195063	150	150	Class C	1 Sign(s) / Pack
Class B Photoluminescent Polypropylene				
195257	150	150	Class B	1 Sign(s) / Pack
Class C Photoluminescent Polypropylene				
139467	150	150	Class C	1 Sign(s) / Pack

IMO153 – POWDER HOSE AND LANCE



Order Ref.	Width (mm)	Height (mm)	Class	Total Qty/Pack
Class B Photoluminescent Polyester				
195411	150	150	Class B	1 Sign(s) / Pack
Class C Photoluminescent Polyester				
195064	150	150	Class C	1 Sign(s) / Pack
Class B Photoluminescent Polypropylene				
195258	150	150	Class B	1 Sign(s) / Pack
Class C Photoluminescent Polypropylene				
139468	150	150	Class C	1 Sign(s) / Pack

IMO154 – POWDER TRIGGER STATION

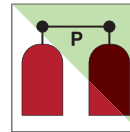

Order Ref.	Width (mm)	Height (mm)	Class	Total Qty/Pack
Class B Photoluminescent Polyester				
195412	150	150	Class B	1 Sign(s) / Pack
Class C Photoluminescent Polyester				
195065	150	150	Class C	1 Sign(s) / Pack
Class B Photoluminescent Polypropylene				
195259	150	150	Class B	1 Sign(s) / Pack
Class C Photoluminescent Polypropylene				
139469	150	150	Class C	1 Sign(s) / Pack

IMO155 – FIRE DETECTOR



Order Ref.	Width (mm)	Height (mm)	Class	Total Qty/Pack
Class B Photoluminescent Polyester				
195413	150	150	Class B	1 Sign(s) / Pack
Class C Photoluminescent Polyester				
195066	150	150	Class C	1 Sign(s) / Pack
Class B Photoluminescent Polypropylene				
195260	150	150	Class B	1 Sign(s) / Pack
Class C Photoluminescent Polypropylene				
139470	150	150	Class C	1 Sign(s) / Pack

IMO156 – SMOKE DETECTOR



Order Ref.	Width (mm)	Height (mm)	Class	Total Qty/Pack
Class B Photoluminescent Polyester				
195414	150	150	Class B	1 Sign(s) / Pack
Class C Photoluminescent Polyester				
195067	150	150	Class C	1 Sign(s) / Pack
Class B Photoluminescent Polypropylene				
195261	150	150	Class B	1 Sign(s) / Pack
Class C Photoluminescent Polypropylene				
139471	150	150	Class C	1 Sign(s) / Pack

IMO157 – EXISTING PLANT WITH FIRE VALVES

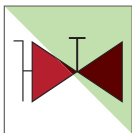

Order Ref.	Width (mm)	Height (mm)	Class	Total Qty/Pack
Class B Photoluminescent Polyester				
195415	150	150	Class B	1 Sign(s) / Pack
Class C Photoluminescent Polyester				
195068	150	150	Class C	1 Sign(s) / Pack
Class B Photoluminescent Polypropylene				
195262	150	150	Class B	1 Sign(s) / Pack
Class C Photoluminescent Polypropylene				
139472	150	150	Class C	1 Sign(s) / Pack

IMO158 – FIRE CABINET WITH SPRINKLER/FIRE HOSE



Order Ref.	Width (mm)	Height (mm)	Class	Total Qty/Pack
Class B Photoluminescent Polyester				
195416	150	150	Class B	1 Sign(s) / Pack
Class C Photoluminescent Polyester				
195069	150	150	Class C	1 Sign(s) / Pack
Class B Photoluminescent Polypropylene				
195263	150	150	Class B	1 Sign(s) / Pack
Class C Photoluminescent Polypropylene				
139473	150	150	Class C	1 Sign(s) / Pack

IMO159 – INTERNATIONAL COUPLING

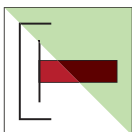

Order Ref.	Width (mm)	Height (mm)	Class	Total Qty/Pack
Class B Photoluminescent Polyester				
195417	150	150	Class B	1 Sign(s) / Pack
Class C Photoluminescent Polyester				
195070	150	150	Class C	1 Sign(s) / Pack
Class B Photoluminescent Polypropylene				
195264	150	150	Class B	1 Sign(s) / Pack
Class C Photoluminescent Polypropylene				
139474	150	150	Class C	1 Sign(s) / Pack

IMO160 – FIRE PUMP

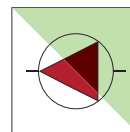

Order Ref.	Width (mm)	Height (mm)	Class	Total Qty/Pack
Class B Photoluminescent Polyester				
195418	150	150	Class B	1 Sign(s) / Pack
Class C Photoluminescent Polyester				
195071	150	150	Class C	1 Sign(s) / Pack
Class B Photoluminescent Polypropylene				
195265	150	150	Class B	1 Sign(s) / Pack
Class C Photoluminescent Polypropylene				
139475	150	150	Class C	1 Sign(s) / Pack

FIRE SAFETY

IMO161 – HEAT DETECTOR



Order Ref.	Width (mm)	Height (mm)	Class	Total Qty/Pack
Class B Photoluminescent Polyester				
195419	150	150	Class B	1 Sign(s) / Pack
Class C Photoluminescent Polyester				
195072	150	150	Class C	1 Sign(s) / Pack
Class B Photoluminescent Polypropylene				
195266	150	150	Class B	1 Sign(s) / Pack
Class C Photoluminescent Polypropylene				
139476	150	150	Class C	1 Sign(s) / Pack

IMO162 – GAS DETECTOR

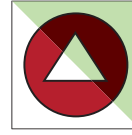

Order Ref.	Width (mm)	Height (mm)	Class	Total Qty/Pack
Class B Photoluminescent Polyester				
195420	150	150	Class B	1 Sign(s) / Pack
Class C Photoluminescent Polyester				
195073	150	150	Class C	1 Sign(s) / Pack
Class B Photoluminescent Polypropylene				
195267	150	150	Class B	1 Sign(s) / Pack
Class C Photoluminescent Polypropylene				
139477	150	150	Class C	1 Sign(s) / Pack

IMO163 – FIRE DAMPER IN THE VENTILATION LINE

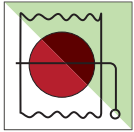

Order Ref.	Width (mm)	Height (mm)	Class	Total Qty/Pack
Class B Photoluminescent Polyester				
195421	150	150	Class B	1 Sign(s) / Pack
Class C Photoluminescent Polyester				
195074	150	150	Class C	1 Sign(s) / Pack
Class B Photoluminescent Polypropylene				
195197	150	150	Class B	1 Sign(s) / Pack
Class C Photoluminescent Polypropylene				
139478	150	150	Class C	1 Sign(s) / Pack

IMO164 – REMOTE-CONTROLLED SKYLIGHTS

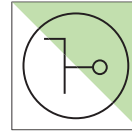

Order Ref.	Width (mm)	Height (mm)	Class	Total Qty/Pack
Class B Photoluminescent Polyester				
195422	150	150	Class B	1 Sign(s) / Pack
Class C Photoluminescent Polyester				
195075	150	150	Class C	1 Sign(s) / Pack
Class B Photoluminescent Polypropylene				
195268	150	150	Class B	1 Sign(s) / Pack
Class C Photoluminescent Polypropylene				
139479	150	150	Class C	1 Sign(s) / Pack

IMO165 – REMOTE-CONTROLLED FUEL/LUBRICATING OIL VALVES

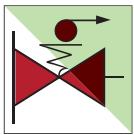

Order Ref.	Width (mm)	Height (mm)	Class	Total Qty/Pack
Class B Photoluminescent Polyester				
195423	150	150	Class B	1 Sign(s) / Pack
Class C Photoluminescent Polyester				
195076	150	150	Class C	1 Sign(s) / Pack
Class B Photoluminescent Polypropylene				
195198	150	150	Class B	1 Sign(s) / Pack
Class C Photoluminescent Polypropylene				
139480	150	150	Class C	1 Sign(s) / Pack

IMO166 – CONTROL STATION



Order Ref.	Width (mm)	Height (mm)	Class	Total Qty/Pack
Class B Photoluminescent Polyester				
195424	150	150	Class B	1 Sign(s) / Pack
Class C Photoluminescent Polyester				
195077	150	150	Class C	1 Sign(s) / Pack
Class B Photoluminescent Polypropylene				
195269	150	150	Class B	1 Sign(s) / Pack
Class C Photoluminescent Polypropylene				
139481	150	150	Class C	1 Sign(s) / Pack

IMO167 – CABINET CONTAINING FIREFIGHTING SUIT



Order Ref.	Width (mm)	Height (mm)	Class	Total Qty/Pack
Class B Photoluminescent Polyester				
195425	150	150	Class B	1 Sign(s) / Pack
Class C Photoluminescent Polyester				
195078	150	150	Class C	1 Sign(s) / Pack
Class B Photoluminescent Polypropylene				
195270	150	150	Class B	1 Sign(s) / Pack
Class C Photoluminescent Polypropylene				
139482	150	150	Class C	1 Sign(s) / Pack

IMO169 – CABINET CONTAINING PROTECTIVE CLOTHING



Order Ref.	Width (mm)	Height (mm)	Class	Total Qty/Pack
Class B Photoluminescent Polyester				
195427	150	150	Class B	1 Sign(s) / Pack
Class C Photoluminescent Polyester				
195080	150	150	Class C	1 Sign(s) / Pack
Class B Photoluminescent Polypropylene				
195272	150	150	Class B	1 Sign(s) / Pack
Class C Photoluminescent Polypropylene				
139484	150	150	Class C	1 Sign(s) / Pack

IMO170 – MAIN ROUTE OF EVACUATION



Order Ref.	Width (mm)	Height (mm)	Class	Total Qty/Pack
Class B Photoluminescent Polyester				
195428	150	150	Class B	1 Sign(s) / Pack
Class C Photoluminescent Polyester				
195081	150	150	Class C	1 Sign(s) / Pack
Class B Photoluminescent Polypropylene				
195273	150	150	Class B	1 Sign(s) / Pack
Class C Photoluminescent Polypropylene				
139485	150	150	Class C	1 Sign(s) / Pack

IMO171 – SECONDARY EVACUATION ROUTE

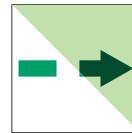

Order Ref.	Width (mm)	Height (mm)	Class	Total Qty/Pack
Class B Photoluminescent Polyester				
195429	150	150	Class B	1 Sign(s) / Pack
Class C Photoluminescent Polyester				
195082	150	150	Class C	1 Sign(s) / Pack
Class B Photoluminescent Polypropylene				
195274	150	150	Class B	1 Sign(s) / Pack
Class C Photoluminescent Polypropylene				
139486	150	150	Class C	1 Sign(s) / Pack

IMO172 – DEVICE FOR SHUTTING OFF ENTRY OR EXIT OF THE EXTERNAL VENTILATION

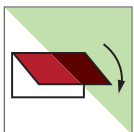

Order Ref.	Width (mm)	Height (mm)	Class	Total Qty/Pack
Class B Photoluminescent Polyester				
195430	150	150	Class B	1 Sign(s) / Pack
Class C Photoluminescent Polyester				
195083	150	150	Class C	1 Sign(s) / Pack
Class B Photoluminescent Polypropylene				
195275	150	150	Class B	1 Sign(s) / Pack
Class C Photoluminescent Polypropylene				
139487	150	150	Class C	1 Sign(s) / Pack

IMO173 – INERT GAS EXTINGUISHER SYSTEM



Order Ref.	Width (mm)	Height (mm)	Class	Total Qty/Pack
Class B Photoluminescent Polyester				
195431	150	150	Class B	1 Sign(s) / Pack
Class C Photoluminescent Polyester				
195084	150	150	Class C	1 Sign(s) / Pack
Class B Photoluminescent Polypropylene				
195276	150	150	Class B	1 Sign(s) / Pack
Class C Photoluminescent Polypropylene				
139488	150	150	Class C	1 Sign(s) / Pack

Compliant with ISO 24409 standard

FIRE SAFETY

IMO174 – HIGH-EXPANSION CAPACITY FOAM SUPPLY TANK

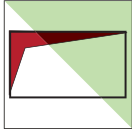

Order Ref.	Width (mm)	Height (mm)	Class	Total Qty/Pack
Class B Photoluminescent Polyester				
195432	150	150	Class B	1 Sign(s) / Pack
Class C Photoluminescent Polyester				
195085	150	150	Class C	1 Sign(s) / Pack
Class B Photoluminescent Polypropylene				
195199	150	150	Class B	1 Sign(s) / Pack
Class C Photoluminescent Polypropylene				
139489	150	150	Class C	1 Sign(s) / Pack

IMO175 – TANK OF CO2/NITROGEN

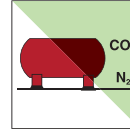

Order Ref.	Width (mm)	Height (mm)	Class	Total Qty/Pack
Class B Photoluminescent Polyester				
195433	150	150	Class B	1 Sign(s) / Pack
Class C Photoluminescent Polyester				
195086	150	150	Class C	1 Sign(s) / Pack
Class B Photoluminescent Polypropylene				
195277	150	150	Class B	1 Sign(s) / Pack
Class C Photoluminescent Polypropylene				
139490	150	150	Class C	1 Sign(s) / Pack

IMO176 – EMERGENCY GENERATOR



Order Ref.	Width (mm)	Height (mm)	Class	Total Qty/Pack
Class B Photoluminescent Polyester				
195434	150	150	Class B	1 Sign(s) / Pack
Class C Photoluminescent Polyester				
195087	150	150	Class C	1 Sign(s) / Pack
Class B Photoluminescent Polypropylene				
195278	150	150	Class B	1 Sign(s) / Pack
Class C Photoluminescent Polypropylene				
139491	150	150	Class C	1 Sign(s) / Pack

IMO177 – EMERGENCY CONTROL PANEL

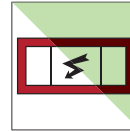

Order Ref.	Width (mm)	Height (mm)	Class	Total Qty/Pack
Class B Photoluminescent Polyester				
195435	150	150	Class B	1 Sign(s) / Pack
Class C Photoluminescent Polyester				
195088	150	150	Class C	1 Sign(s) / Pack
Class B Photoluminescent Polypropylene				
195279	150	150	Class B	1 Sign(s) / Pack
Class C Photoluminescent Polypropylene				
139492	150	150	Class C	1 Sign(s) / Pack

IMO178 – REMOTE SWITCH FOR VENTILATION



Order Ref.	Width (mm)	Height (mm)	Class	Total Qty/Pack
Class B Photoluminescent Polyester				
195436	150	150	Class B	1 Sign(s) / Pack
Class C Photoluminescent Polyester				
195089	150	150	Class C	1 Sign(s) / Pack
Class B Photoluminescent Polypropylene				
195280	150	150	Class B	1 Sign(s) / Pack
Class C Photoluminescent Polypropylene				
139493	150	150	Class C	1 Sign(s) / Pack

IMO179 – PORTABLE P6 EXTINGUISHER

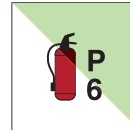

Order Ref.	Width (mm)	Height (mm)	Class	Total Qty/Pack
Class B Photoluminescent Polyester				
195437	150	150	Class B	1 Sign(s) / Pack
Class C Photoluminescent Polyester				
195090	150	150	Class C	1 Sign(s) / Pack
Class B Photoluminescent Polypropylene				
195281	150	150	Class B	1 Sign(s) / Pack
Class C Photoluminescent Polypropylene				
139494	150	150	Class C	1 Sign(s) / Pack

IMO180 – PORTABLE LW9 EXTINGUISHER

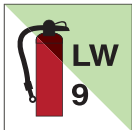

Order Ref.	Width (mm)	Height (mm)	Class	Total Qty/Pack
Class B Photoluminescent Polyester				
195438	150	150	Class B	1 Sign(s) / Pack
Class C Photoluminescent Polyester				
195091	150	150	Class C	1 Sign(s) / Pack
Class B Photoluminescent Polypropylene				
195282	150	150	Class B	1 Sign(s) / Pack
Class C Photoluminescent Polypropylene				
139495	150	150	Class C	1 Sign(s) / Pack

IMO181 – PORTABLE EXTINGUISHER WITH HALON 1211/4



Order Ref.	Width (mm)	Height (mm)	Class	Total Qty/Pack
Class B Photoluminescent Polyester				
195439	150	150	Class B	1 Sign(s) / Pack
Class C Photoluminescent Polyester				
195092	150	150	Class C	1 Sign(s) / Pack
Class B Photoluminescent Polypropylene				
195283	150	150	Class B	1 Sign(s) / Pack
Class C Photoluminescent Polypropylene				
139496	150	150	Class C	1 Sign(s) / Pack

IMO182 – CO2/2 PORTABLE EXTINGUISHER

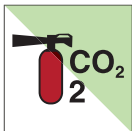

Order Ref.	Width (mm)	Height (mm)	Class	Total Qty/Pack
Class B Photoluminescent Polyester				
195440	150	150	Class B	1 Sign(s) / Pack
Class C Photoluminescent Polyester				
195093	150	150	Class C	1 Sign(s) / Pack
Class B Photoluminescent Polypropylene				
195284	150	150	Class B	1 Sign(s) / Pack
Class C Photoluminescent Polypropylene				
139497	150	150	Class C	1 Sign(s) / Pack

IMO183 – PORTABLE P2 EXTINGUISHER

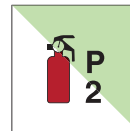

Order Ref.	Width (mm)	Height (mm)	Class	Total Qty/Pack
Class B Photoluminescent Polyester				
195441	150	150	Class B	1 Sign(s) / Pack
Class C Photoluminescent Polyester				
195094	150	150	Class C	1 Sign(s) / Pack
Class B Photoluminescent Polypropylene				
195285	150	150	Class B	1 Sign(s) / Pack
Class C Photoluminescent Polypropylene				
139498	150	150	Class C	1 Sign(s) / Pack

IMO184 – PORTABLE P1 EXTINGUISHER

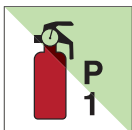

Order Ref.	Width (mm)	Height (mm)	Class	Total Qty/Pack
Class B Photoluminescent Polyester				
195442	150	150	Class B	1 Sign(s) / Pack
Class C Photoluminescent Polyester				
195095	150	150	Class C	1 Sign(s) / Pack
Class B Photoluminescent Polypropylene				
195286	150	150	Class B	1 Sign(s) / Pack
Class C Photoluminescent Polypropylene				
139499	150	150	Class C	1 Sign(s) / Pack

IMO185 – P50 WHEEL-MOUNTED EXTINGUISHER

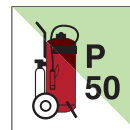

Order Ref.	Width (mm)	Height (mm)	Class	Total Qty/Pack
Class B Photoluminescent Polyester				
195443	150	150	Class B	1 Sign(s) / Pack
Class C Photoluminescent Polyester				
195096	150	150	Class C	1 Sign(s) / Pack
Class B Photoluminescent Polypropylene				
195287	150	150	Class B	1 Sign(s) / Pack
Class C Photoluminescent Polypropylene				
139500	150	150	Class C	1 Sign(s) / Pack

FIRE SAFETY

IM0186 – CO2/30 WHEEL-MOUNTED FIRE EXTINGUISHER CO2/30

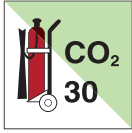

Order Ref.	Width (mm)	Height (mm)	Class	Total Qty/Pack
Class B Photoluminescent Polyester				
195444	150	150	Class B	1 Sign(s) / Pack
Class C Photoluminescent Polyester				
195097	150	150	Class C	1 Sign(s) / Pack
Class B Photoluminescent Polypropylene				
195288	150	150	Class B	1 Sign(s) / Pack
Class C Photoluminescent Polypropylene				
139501	150	150	Class C	1 Sign(s) / Pack

IM0401 – EXTINGUISHER



Order Ref.	Width (mm)	Height (mm)	Class	Total Qty/Pack
Class B Photoluminescent Polyester				
195504	150	150	Class B	1 Sign(s) / Pack
Class C Photoluminescent Polyester				
195190	150	150	Class C	1 Sign(s) / Pack
Class B Photoluminescent Polypropylene				
195344	150	150	Class B	1 Sign(s) / Pack
Class C Photoluminescent Polypropylene				
194997	150	150	Class C	1 Sign(s) / Pack

IM0402 – FIRE ALARM POST



Order Ref.	Width (mm)	Height (mm)	Class	Total Qty/Pack
Class B Photoluminescent Polyester				
195505	150	150	Class B	1 Sign(s) / Pack
Class C Photoluminescent Polyester				
195191	150	150	Class C	1 Sign(s) / Pack
Class B Photoluminescent Polypropylene				
195345	150	150	Class B	1 Sign(s) / Pack
Class C Photoluminescent Polypropylene				
194998	150	150	Class C	1 Sign(s) / Pack

IM0403 – FIRE HOSE REEL



Order Ref.	Width (mm)	Height (mm)	Class	Total Qty/Pack
Class B Photoluminescent Polyester				
195506	150	150	Class B	1 Sign(s) / Pack
Class C Photoluminescent Polyester				
195192	150	150	Class C	1 Sign(s) / Pack
Class B Photoluminescent Polypropylene				
195346	150	150	Class B	1 Sign(s) / Pack
Class C Photoluminescent Polypropylene				
194999	150	150	Class C	1 Sign(s) / Pack

IM0404 – EMERGENCY PHONE IN THE EVENT OF FIRE



Order Ref.	Width (mm)	Height (mm)	Class	Total Qty/Pack
Class B Photoluminescent Polyester				
195507	150	150	Class B	1 Sign(s) / Pack
Class C Photoluminescent Polyester				
195193	150	150	Class C	1 Sign(s) / Pack
Class B Photoluminescent Polypropylene				
195347	150	150	Class B	1 Sign(s) / Pack
Class C Photoluminescent Polypropylene				
195000	150	150	Class C	1 Sign(s) / Pack

IM0405 – FIRE-FIGHTING EQUIPMENT



Order Ref.	Width (mm)	Height (mm)	Class	Total Qty/Pack
Class B Photoluminescent Polyester				
195508	150	150	Class B	1 Sign(s) / Pack
Class C Photoluminescent Polyester				
195194	150	150	Class C	1 Sign(s) / Pack
Class B Photoluminescent Polypropylene				
195348	150	150	Class B	1 Sign(s) / Pack
Class C Photoluminescent Polypropylene				
195001	150	150	Class C	1 Sign(s) / Pack

IM0406 – 90° DIRECTION ARROW



Order Ref.	Width (mm)	Height (mm)	Class	Total Qty/Pack
Class B Photoluminescent Polyester				
195509	150	150	Class B	1 Sign(s) / Pack
Class C Photoluminescent Polyester				
195195	150	150	Class C	1 Sign(s) / Pack
Class B Photoluminescent Polypropylene				
195204	150	150	Class B	1 Sign(s) / Pack
Class C Photoluminescent Polypropylene				
195138	150	150	Class C	1 Sign(s) / Pack

IM0407 – 45° DIRECTION ARROW



Order Ref.	Width (mm)	Height (mm)	Class	Total Qty/Pack
Class B Photoluminescent Polyester				
195510	150	150	Class B	1 Sign(s) / Pack
Class C Photoluminescent Polyester				
195196	150	150	Class C	1 Sign(s) / Pack
Class B Photoluminescent Polypropylene				
195205	150	150	Class B	1 Sign(s) / Pack
Class C Photoluminescent Polypropylene				
195139	150	150	Class C	1 Sign(s) / Pack

IM0421 – NUMBER 0



Order Ref.	Width (mm)	Height (mm)	Class	Legend	Total Qty/Pack
Class B Photoluminescent Polyester					
195511	150	150	Class B	0	1 Sign(s) / Pack
Class C Photoluminescent Polyester					
195127	150	150	Class C	0	1 Sign(s) / Pack
Class B Photoluminescent Polypropylene					
195349	150	150	Class B	0	1 Sign(s) / Pack
Class C Photoluminescent Polypropylene					
195002	150	150	Class C	0	1 Sign(s) / Pack

IM0422 – NUMBER 1



Order Ref.	Width (mm)	Height (mm)	Class	Legend	Total Qty/Pack
Class B Photoluminescent Polyester					
195512	150	150	Class B	1	1 Sign(s) / Pack
Class C Photoluminescent Polyester					
195128	150	150	Class C	1	1 Sign(s) / Pack
Class B Photoluminescent Polypropylene					
195350	150	150	Class B	1	1 Sign(s) / Pack
Class C Photoluminescent Polypropylene					
195003	150	150	Class C	1	1 Sign(s) / Pack

IM0423 – NUMBER 2



Order Ref.	Width (mm)	Height (mm)	Class	Legend	Total Qty/Pack
Class B Photoluminescent Polyester					
195513	150	150	Class B	2	1 Sign(s) / Pack
Class C Photoluminescent Polyester					
195129	150	150	Class C	2	1 Sign(s) / Pack
Class B Photoluminescent Polypropylene					
195351	150	150	Class B	2	1 Sign(s) / Pack
Class C Photoluminescent Polypropylene					
195004	150	150	Class C	2	1 Sign(s) / Pack

IM0424 – NUMBER 3



Order Ref.	Width (mm)	Height (mm)	Class	Legend	Total Qty/Pack
Class B Photoluminescent Polyester					
195514	150	150	Class B	3	1 Sign(s) / Pack
Class C Photoluminescent Polyester					
195130	150	150	Class C	3	1 Sign(s) / Pack
Class B Photoluminescent Polypropylene					
195352	150	150	Class B	3	1 Sign(s) / Pack
Class C Photoluminescent Polypropylene					
195005	150	150	Class C	3	1 Sign(s) / Pack

Compliant with ISO 24409 standard

FIRE SAFETY

IMO425 – NUMBER 4



Order Ref.	Width (mm)	Height (mm)	Class	Le-gend	Total Qty/Pack
Class B Photoluminescent Polyester					
195515	150	150	Class B	4	1 Sign(s) / Pack
Class C Photoluminescent Polyester					
195131	150	150	Class C	4	1 Sign(s) / Pack
Class B Photoluminescent Polypropylene					
195353	150	150	Class B	4	1 Sign(s) / Pack
Class C Photoluminescent Polypropylene					
195006	150	150	Class C	4	1 Sign(s) / Pack

IMO426 – NUMBER 5



Order Ref.	Width (mm)	Height (mm)	Class	Le-gend	Total Qty/Pack
Class B Photoluminescent Polyester					
195516	150	150	Class B	5	1 Sign(s) / Pack
Class C Photoluminescent Polyester					
195132	150	150	Class C	5	1 Sign(s) / Pack
Class B Photoluminescent Polypropylene					
195354	150	150	Class B	5	1 Sign(s) / Pack
Class C Photoluminescent Polypropylene					
195007	150	150	Class C	5	1 Sign(s) / Pack

IMO427 – NUMBER 6



Order Ref.	Width (mm)	Height (mm)	Class	Le-gend	Total Qty/Pack
Class B Photoluminescent Polyester					
195517	150	150	Class B	6	1 Sign(s) / Pack
Class C Photoluminescent Polyester					
195133	150	150	Class C	6	1 Sign(s) / Pack
Class B Photoluminescent Polypropylene					
195355	150	150	Class B	6	1 Sign(s) / Pack
Class C Photoluminescent Polypropylene					
195008	150	150	Class C	6	1 Sign(s) / Pack

IMO428 – NUMBER 7



Order Ref.	Width (mm)	Height (mm)	Class	Le-gend	Total Qty/Pack
Class B Photoluminescent Polyester					
195518	150	150	Class B	7	1 Sign(s) / Pack
Class C Photoluminescent Polyester					
195134	150	150	Class C	7	1 Sign(s) / Pack
Class B Photoluminescent Polypropylene					
195356	150	150	Class B	7	1 Sign(s) / Pack
Class C Photoluminescent Polypropylene					
195009	150	150	Class C	7	1 Sign(s) / Pack

IMO429 – NUMBER 8



Order Ref.	Width (mm)	Height (mm)	Class	Le-gend	Total Qty/Pack
Class B Photoluminescent Polyester					
195519	150	150	Class B	8	1 Sign(s) / Pack
Class C Photoluminescent Polyester					
195135	150	150	Class C	8	1 Sign(s) / Pack
Class B Photoluminescent Polypropylene					
195357	150	150	Class B	8	1 Sign(s) / Pack
Class C Photoluminescent Polypropylene					
195010	150	150	Class C	8	1 Sign(s) / Pack

IMO430 – NUMBER 9



Order Ref.	Width (mm)	Height (mm)	Class	Le-gend	Total Qty/Pack
Class B Photoluminescent Polyester					
195520	150	150	Class B	9	1 Sign(s) / Pack
Class C Photoluminescent Polyester					
195136	150	150	Class C	9	1 Sign(s) / Pack
Class B Photoluminescent Polypropylene					
195358	150	150	Class B	9	1 Sign(s) / Pack
Class C Photoluminescent Polypropylene					
195011	150	150	Class C	9	1 Sign(s) / Pack



MANDATORY

IMO168 – BREATHING APPARATUS



Order Ref.	Width (mm)	Height (mm)	Class	Total Qty/Pack
Class B Photoluminescent Polyester				
195426	150	150	Class B	1 Sign(s) / Pack
Class C Photoluminescent Polyester				
195079	150	150	Class C	1 Sign(s) / Pack
Class B Photoluminescent Polypropylene				
195271	150	150	Class B	1 Sign(s) / Pack
Class C Photoluminescent Polypropylene				
139483	150	150	Class C	1 Sign(s) / Pack

IMO201 – ATTACH SAFETY BELT



Order Ref.	Width (mm)	Height (mm)	Class	Total Qty/Pack
Class B Photoluminescent Polyester				
195445	150	150	Class B	1 Sign(s) / Pack
Class C Photoluminescent Polyester				
195098	150	150	Class C	1 Sign(s) / Pack
Class B Photoluminescent Polypropylene				
195289	150	150	Class B	1 Sign(s) / Pack
Class C Photoluminescent Polypropylene				
139502	150	150	Class C	1 Sign(s) / Pack

IMO202 – CLOSE AND ATTACH TRAPS IN THE LAUNCHING ORDER



Order Ref.	Width (mm)	Height (mm)	Class	Total Qty/Pack
Class B Photoluminescent Polyester				
195446	150	150	Class B	1 Sign(s) / Pack
Class C Photoluminescent Polyester				
195099	150	150	Class C	1 Sign(s) / Pack
Class B Photoluminescent Polypropylene				
195290	150	150	Class B	1 Sign(s) / Pack
Class C Photoluminescent Polypropylene				
139503	150	150	Class C	1 Sign(s) / Pack

IMO203 – START THE MOTOR IN THE LAUNCHING ORDER



Order Ref.	Width (mm)	Height (mm)	Class	Total Qty/Pack
Class B Photoluminescent Polyester				
195447	150	150	Class B	1 Sign(s) / Pack
Class C Photoluminescent Polyester				
195100	150	150	Class C	1 Sign(s) / Pack
Class B Photoluminescent Polypropylene				
195291	150	150	Class B	1 Sign(s) / Pack
Class C Photoluminescent Polypropylene				
139504	150	150	Class C	1 Sign(s) / Pack

IMO204 – LOWER LIFEBOAT INTO THE WATER FOLLOWING THE LAUNCH SEQUENCE



Order Ref.	Width (mm)	Height (mm)	Class	Total Qty/Pack
Class B Photoluminescent Polyester				
195448	150	150	Class B	1 Sign(s) / Pack
Class C Photoluminescent Polyester				
195101	150	150	Class C	1 Sign(s) / Pack
Class B Photoluminescent Polypropylene				
195292	150	150	Class B	1 Sign(s) / Pack
Class C Photoluminescent Polypropylene				
139505	150	150	Class C	1 Sign(s) / Pack

IMO205 – LOWER THE LIFE RAFT INTO THE WATER FOLLOWING THE LAUNCHING ORDER



Order Ref.	Width (mm)	Height (mm)	Class	Total Qty/Pack
Class B Photoluminescent Polyester				
195449	150	150	Class B	1 Sign(s) / Pack
Class C Photoluminescent Polyester				
195102	150	150	Class C	1 Sign(s) / Pack
Class B Photoluminescent Polypropylene				
195293	150	150	Class B	1 Sign(s) / Pack
Class C Photoluminescent Polypropylene				
139506	150	150	Class C	1 Sign(s) / Pack

IMO206 – LOWER THE LIFERAFT INTO THE WATER FOLLOWING THE LAUNCHING ORDER



Order Ref.	Width (mm)	Height (mm)	Class	Total Qty/Pack
Class B Photoluminescent Polyester				
195450	150	150	Class B	1 Sign(s) / Pack
Class C Photoluminescent Polyester				
195103	150	150	Class C	1 Sign(s) / Pack
Class B Photoluminescent Polypropylene				
195294	150	150	Class B	1 Sign(s) / Pack
Class C Photoluminescent Polypropylene				
139507	150	150	Class C	1 Sign(s) / Pack

IMO207 – FREE HARNESSES FOLLOWING THE LAUNCHING ORDER



Order Ref.	Width (mm)	Height (mm)	Class	Total Qty/Pack
Class B Photoluminescent Polyester				
195451	150	150	Class B	1 Sign(s) / Pack
Class C Photoluminescent Polyester				
195104	150	150	Class C	1 Sign(s) / Pack
Class B Photoluminescent Polypropylene				
195295	150	150	Class B	1 Sign(s) / Pack
Class C Photoluminescent Polypropylene				
139508	150	150	Class C	1 Sign(s) / Pack

IMO208 – START WATER SPRINKLER FOLLOWING THE LAUNCHING ORDER



Order Ref.	Width (mm)	Height (mm)	Class	Total Qty/Pack
Class B Photoluminescent Polyester				
195452	150	150	Class B	1 Sign(s) / Pack
Class C Photoluminescent Polyester				
195105	150	150	Class C	1 Sign(s) / Pack
Class B Photoluminescent Polypropylene				
195296	150	150	Class B	1 Sign(s) / Pack
Class C Photoluminescent Polypropylene				
139509	150	150	Class C	1 Sign(s) / Pack

IMO209 – START AIR SUPPLY FOLLOWING THE LAUNCHING ORDER



Order Ref.	Width (mm)	Height (mm)	Class	Total Qty/Pack
Class B Photoluminescent Polyester				
195453	150	150	Class B	1 Sign(s) / Pack
Class C Photoluminescent Polyester				
195106	150	150	Class C	1 Sign(s) / Pack
Class B Photoluminescent Polypropylene				
195297	150	150	Class B	1 Sign(s) / Pack
Class C Photoluminescent Polypropylene				
139510	150	150	Class C	1 Sign(s) / Pack

IMO210 – FREE UP THE LIFEBOAT SLIPWAYS FOLLOWING THE LAUNCHING ORDER



Order Ref.	Width (mm)	Height (mm)	Class	Total Qty/Pack
Class B Photoluminescent Polyester				
195454	150	150	Class B	1 Sign(s) / Pack
Class C Photoluminescent Polyester				
195107	150	150	Class C	1 Sign(s) / Pack
Class B Photoluminescent Polypropylene				
195200	150	150	Class B	1 Sign(s) / Pack
Class C Photoluminescent Polypropylene				
139511	150	150	Class C	1 Sign(s) / Pack



Hazardous substances signage

Do all of your chemical products carry labels?	218
SDS components and label format	219
CLP/GHS pictograms and hazard classes	221
Labels with CLP/GHS symbols	221
CLP/GHS labels for Brady printers	222
Transport signage	223

DO ALL OF YOUR CHEMICAL PRODUCTS CARRY LABELS?

The CLP regulation is an obligatory European regulation that requires, among other things, products containing hazardous chemical products to be clearly identified. The CLP regulation of the European Union is based on the UN Globally Harmonised System for chemical substances. From June 2015, compliance with the CLP regulations will be required for hazardous chemical products and mixtures in all EU member countries. Every substance listed as hazardous and every mixture containing hazardous substances must also include a CLP label from June 2015 onwards.



WHAT IS THE CLP?

Classification, Labelling and Packaging (CLP) of substances and mixtures is the EC regulation 1272/2008 applied throughout the European Union and the labelling of chemical products. The system adopts the Globally Harmonised System of Classification and Labelling of Chemicals (GHS), created by the United Nations.

- The CLP/SGH symbols were introduced into the European Union based on the CLP/SGH regulations (classification, labelling and packaging) adopted in January 2009.
- **CLP/SGH replaces the HSID labelling:** the pictograms of dangerous materials in orange used previously have now been replaced by pictograms in the form of a lozenge on a white background with a red border. The current R+S listings will be replaced by the H note P advice (+ EUH notes). Within the European Union, it has been obligatory since 01.12.2010 to label **chemical substances** in accordance with the regulations. From 01.06.2015 onward, this requirement will also apply to **chemical mixtures**. In the CLP/SGH system, the keywords 'Danger' and 'Attention' must be used, according to the substance.



WHY IS THE GHS IMPORTANT?

The import and export of chemical products is an important sector of the economy

Throughout the world, the production and use of chemical products represents more than 1,500 billion Euros a year (340 billion Euros alone for the US). The labelling of chemical products is made up differently depending on regional requirements. With such an impact on the world economy, it is primordial the import and export of chemical products is done as surely and effectively as possible. The GHS standard helps to keep employees safe and to inform them of the risks associated with chemical products throughout the world.

SDS COMPONENTS AND LABEL FORMAT

6 COMPONENTS OF LABEL

- 1. Keyword:**
Indicates the relative gravity of the hazard. 'Hazard' is used for the majority of serious cases, while 'Attention' is less serious.
- 2. Symbols (hazard pictograms):**
Communicate information on the physical risks for health and the environment with pictograms in a red lozenge. A combination of between one and six symbols may be used.
- 3. Product name or identifiers***
- 4. Hazard statements:**
Statements describing the nature of hazardous products and related risks, where precautionary measures are not taken.
- 5. Safety advice:**
Expressions related with each hazard statement, describing the general precautions for prevention, reaction, storage or scrapping.
- 6. Information about the manufacturer:**
Name, address and phone number of the company.

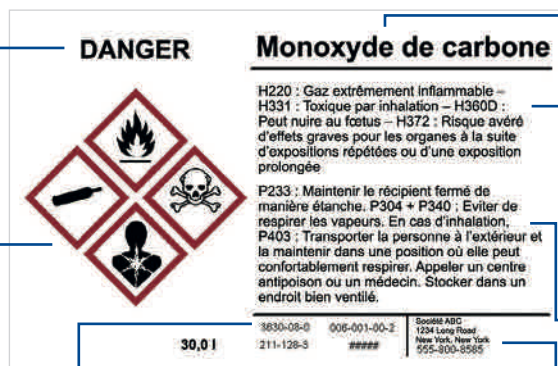

You can find out sign and label printers from page 235 onwards.

16 COMPONENTS OF SAFETY DATA SHEETS

Safety Data Sheets (SDS) are the main tools to ensure that suppliers provide sufficient information throughout the chain to facilitate safe use of substances and mixtures. Each Safety Data Sheet (SDS) must use the same structure, including the following sections.

- Section 1: Identification**
 - Chemical product and recommended usage, and details of supplier.
- Section 2: Identification of hazard(s)**
 - Hazards of chemical product and suitable warning information.
- Section 3: Composition/ information on ingredients**
 - Ingredients contained in the products.
- Section 4: First-aid measures**
 - First aid to be provided by untrained staff on an individual exposed to a chemical product.
- Section 5: Fire-fighting measures**
 - Instructions for fire-fighting caused by a chemical product.
- Section 6: Measures in the event of accidental spillage**
 - Appropriate reaction to take with spillages, leaks or emissions, including retaining and cleaning practices.
- Section 7: Handling and storage**
 - Safe handling and storage practices for safe storage of chemical products.
- Section 8: Individual protection/ exposure inspections**
 - Exposure limits, technical controls and individual protection measures in order to minimise the exposure of employees.
- Section 9: Physical and chemical properties**
 - Physical and chemical properties related with the substance or the mixture.
- Section 10: Stability and reactivity**
 - Information about hazards of stability and reactivity.
- Section 11: Toxicological information**
 - Toxicological information relating to the health effects or indicator that such information is not available.
- Section 12: Ecological information**
 - Environmental impact of chemical product(s) in case of release into the environment.
- Section 13: Considerations relating to scrapping**
 - Suitable practices for scrapping, recycling or recovery and sound practices for handling.
- Section 14: Information for transport**
 - Classification information for shipment and transport.
- Section 15: Regulatory information**
 - Regulations for health safety and the environment specific to the product, which are not indicated in any other part of the SDS.
- Section 16: Other information**
 - Date of issue or last known revision of the SDS.

CLP/GHS PICTOGRAMS AND HAZARD CLASSES

The new CLP/GHS symbols, also known as hazard pictograms, are specifically designed and used to identify dangerous products. The pictograms are generally distributed in three hazard classes: chemical/physical risks, health risks and environmental risks.

GHS05 Corrosive

(Pictogram of corrosion)



Identify chemical products displaying the following hazards:

- Burns/corrosive to skin
- Eye infections
- Metal corrosion

GHS04 Gas bottle

(Pictogram of a bottle)



Identify chemical products displaying the following hazards:

- Pressurised gas

GHS03 Oxidant

(Pictogram of a flame in a circle)



Identify chemical products displaying the following hazards:

- Oxidants

GHS02 Flame

(Pictogram of a flame)



Identify chemical products displaying the following hazards:

- Inflammable
- Pyrophoric
- Self-heating
- Emits a flammable gas
- Self-reactive
- Organic peroxides

GHS01 Explosive

(Pictogram of an exploding bomb)



Identify chemical products displaying the following hazards:

- Explosives
- Self-reactive
- Organic peroxides

GHS07 Acute toxicity

(Pictogram of exclamation mark)



Identify chemical products displaying the following hazards:

- Irritant (skin and eyes)
- Skin sensitiser
- Acute toxicity (harmful)*
- Narcotic effects
- Infection of respiratory tracts
- Dangerous for the ozone layer (optional)

You can find out sign and label printers from page 235 onwards.

GHS08 Health risk

(Pictogram of health risk)



Identify chemical products displaying the following hazards:

- Carcinogenic
- Mutagenicity
- Toxic for the reproductive system
- Respiratory sensitiser
- Toxic for major organs
- Toxic for respiration

GHS06 Serious toxicity

(Pictogram of a skull and crossbones)



Identify chemical products displaying the following hazards:

- Acute toxicity (fatal or toxic)*

You can find out sign and label printers from page 235 onwards.

GHS09 Environmental

(Environment pictogram)



Identify chemical products displaying the following hazards:

- Aquatic toxicity

LABELS WITH CLP/GHS SYMBOLS

Brady has a vast range of pre-printed labels to identify your chemical product containers.

- High-quality labels that can withstand the most demanding environments
- Extremely durable materials that enable you to label your products one time for all
- Highly resistant to bad weather, abrasion and chemical products
- These labels can withstand temperatures ranging from -40°C and +120°C



Width (mm) x Height (mm)	Layout	Total Qty/Pack	GHS01	GHS02	GHS03	GHS04	GHS05	GHS06	GHS07	GHS08	GHS09
			PIC 1801	PIC 1802	PIC 1803	PIC 1804	PIC 1808	PIC 1809	PIC 1805	PIC 1807	PIC 1806
21 x 21	Individual Markers on a Roll	250 Label(s) / Roll	834184	834186	834180	834185	834181	834188	834182	834187	834183
50 x 50	Continuous Roll	250 Label(s) / Roll	811681	811686	811691	811696	811716	811721	811701	811711	811706
50 x 50	Individual Markers on a Roll	250 Label(s) / Roll	814032	814033	814034	814035	814039	814040	814036	814038	814037
100 x 100	Continuous Roll	250 Label(s) / Roll	814023	814024	814025	814026	814030	814031	814027	814029	814028
100 x 100	Individual Markers on a Roll	250 Label(s) / Roll	811679	811684	811689	811694	811714	811719	811699	811709	811704
10 x 10	Card Mounted	96 Sign(s) / Sheet	814014	814015	814016	814017	814021	814022	814018	814020	814019
40 x 40	Card Mounted	20 Label(s) / Card	811680	811685	811690	811695	811715	811720	811700	811710	811705
70 x 70	Card Mounted	6 Label(s) / Card	811682	811687	811692	811697	811717	811722	811702	811712	811707
100 x 100	Card Mounted	4 Label(s) / Card	811678	811683	811688	811693	811713	811718	811698	811708	811703

MINI-PICTOGRAMS MIX



Order Ref.	Width (mm)	Height (mm)	Total Qty/Pack
Laminated Polyester			
814013	10	10	104 Sign(s) / Sheet

1 sheet contains: 11 off each PIC1801, PIC1803, PIC1804, PIC1805, PIC1806, PIC1807, PIC1808, PIC1809 and 16 off PIC1802

CLP/GHS LABELS FOR BRADY PRINTERS

Print 2 colour GHS labels in one fast print pass!

- Blank labels with pre-printed red diamonds allow printer to produce 2 colour GHS/CLP labels in one print pass
- 3 sizes of labels, each with 6 different diamond layouts. Visit www.bradyeurope.com or contact your Brady distributor for more information
- Indoor/outdoor vinyl material withstands exposure to moisture, chemicals and handling



PRE-PRINTED GHS/CLP LABELS FOR BBP™12 LABEL PRINTER

Order Reference	Layout	Label Width A (mm)	Label Height B (mm)	Vertical Repeat D (mm)	Web Width E (mm)	Labels per Row	Labels per Package	Ribbon Series
B-7610: Paper								
THTCLP-S-L1-7610-0.4-SC	L1	55.00	85.00	91.02	59.00	1	400	R7950
THTCLP-S-L2-7610-0.4-SC	L2	55.00	85.00	91.02	59.00	1	400	R7950
THTCLP-S-L3A-7610-0.4-SC	L3A	55.00	85.00	91.02	59.00	1	400	R7950
THTCLP-S-L3B-7610-0.4-SC	L3B	55.00	85.00	91.02	59.00	1	400	R7950
THTCLP-S-L4A-7610-0.4-SC	L4A	55.00	85.00	91.02	59.00	1	400	R7950
THTCLP-S-L4B-7610-0.4-SC	L4B	55.00	85.00	91.02	59.00	1	400	R7950
THTCLP-M-L1-7610-0.3-SC	L1	75.00	110.00	115.36	79.00	1	300	R7950
THTCLP-M-L2-7610-0.3-SC	L2	75.00	110.00	115.36	79.00	1	300	R7950
THTCLP-M-L3A-7610-0.3-SC	L3A	75.00	110.00	115.36	79.00	1	300	R7950
THTCLP-M-L3B-7610-0.3-SC	L3B	75.00	110.00	115.36	79.00	1	300	R7950
THTCLP-M-L4A-7610-0.3-SC	L4A	75.00	110.00	115.36	79.00	1	300	R7950
THTCLP-M-L4B-7610-0.3-SC	L4B	75.00	110.00	115.36	79.00	1	300	R7950
THTCLP-L-L1-7610-0.2-SC	L1	105.00	155.00	160.12	109.00	1	200	R7950
THTCLP-L-L2-7610-0.2-SC	L2	105.00	155.00	160.12	109.00	1	200	R7950
THTCLP-L-L3A-7610-0.2-SC	L3A	105.00	155.00	160.12	109.00	1	200	R7950
THTCLP-L-L3B-7610-0.2-SC	L3B	105.00	155.00	160.12	109.00	1	200	R7950
THTCLP-L-L4A-7610-0.2-SC	L4A	105.00	155.00	160.12	109.00	1	200	R7950
THTCLP-L-L4B-7610-0.2-SC	L4B	105.00	155.00	160.12	109.00	1	200	R7950
B-7594: Polypropylene								
THTCLP-S-L1-7594-0.4-SC	L1	55.00	85.00	91.02	59.00	1	400	R6000HF
THTCLP-S-L2-7594-0.4-SC	L2	55.00	85.00	91.02	59.00	1	400	R6000HF
THTCLP-S-L3A-7594-0.4-SC	L3A	55.00	85.00	91.02	59.00	1	400	R6000HF
THTCLP-S-L3B-7594-0.4-SC	L3B	55.00	85.00	91.02	59.00	1	400	R6000HF
THTCLP-S-L4A-7594-0.4-SC	L4A	55.00	85.00	91.02	59.00	1	400	R6000HF
THTCLP-S-L4B-7594-0.4-SC	L4B	55.00	85.00	91.02	59.00	1	400	R6000HF
THTCLP-M-L1-7594-0.3-SC	L1	75.00	110.00	115.36	79.00	1	300	R6000HF
THTCLP-M-L2-7594-0.3-SC	L2	75.00	110.00	115.36	79.00	1	300	R6000HF
THTCLP-M-L3A-7594-0.3-SC	L3A	75.00	110.00	115.36	79.00	1	300	R6000HF
THTCLP-M-L3B-7594-0.3-SC	L3B	75.00	110.00	115.36	79.00	1	300	R6000HF
THTCLP-M-L4A-7594-0.3-SC	L4A	75.00	110.00	115.36	79.00	1	300	R6000HF
THTCLP-M-L4B-7594-0.3-SC	L4B	75.00	110.00	115.36	79.00	1	300	R6000HF
THTCLP-L-L1-7594-0.2-SC	L1	105.00	155.00	160.12	109.00	1	200	R6000HF
THTCLP-L-L2-7594-0.2-SC	L2	105.00	155.00	160.12	109.00	1	200	R6000HF
THTCLP-L-L3A-7594-0.2-SC	L3A	105.00	155.00	160.12	109.00	1	200	R6000HF
THTCLP-L-L3B-7594-0.2-SC	L3B	105.00	155.00	160.12	109.00	1	200	R6000HF
THTCLP-L-L4A-7594-0.2-SC	L4A	105.00	155.00	160.12	109.00	1	200	R6000HF
THTCLP-L-L4B-7594-0.2-SC	L4B	105.00	155.00	160.12	109.00	1	200	R6000HF

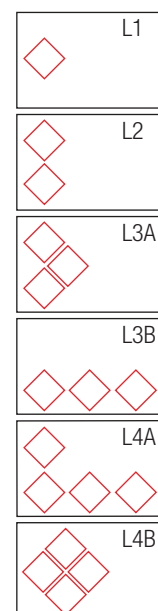
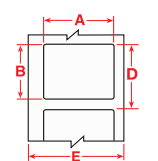

PRE-PRINTED GHS/CLP LABELS FOR BBP™33 LABEL PRINTER

Order Reference	Layout	Label Width A (mm)	Label Height B (mm)	Labels per Row	Labels per Package	Ribbon Series
B-7569: Vinyl						
B30-260-7569-CLP1	L1	55.00	85.00	1	340	B30-R10000
B30-260-7569-CLP2	L2	55.00	85.00	1	340	B30-R10000
B30-260-7569-CLP3A	L3A	55.00	85.00	1	340	B30-R10000
B30-260-7569-CLP3B	L3B	55.00	85.00	1	340	B30-R10000
B30-260-7569-CLP4A	L4A	55.00	85.00	1	340	B30-R10000
B30-260-7569-CLP4B	L4B	55.00	85.00	1	340	B30-R10000
B30-261-7569-CLP1	L1	75.00	110.00	1	270	B30-R10000
B30-261-7569-CLP2	L2	75.00	110.00	1	270	B30-R10000
B30-261-7569-CLP3A	L3A	75.00	110.00	1	270	B30-R10000
B30-261-7569-CLP3B	L3B	75.00	110.00	1	270	B30-R10000
B30-261-7569-CLP4A	L4A	75.00	110.00	1	270	B30-R10000
B30-261-7569-CLP4B	L4B	75.00	110.00	1	270	B30-R10000
B30-262-7569-CLP1	L1	105.00	155.00	1	200	B30-R10000
B30-262-7569-CLP2	L2	105.00	155.00	1	200	B30-R10000
B30-262-7569-CLP3A	L3A	105.00	155.00	1	200	B30-R10000
B30-262-7569-CLP3B	L3B	105.00	155.00	1	200	B30-R10000
B30-262-7569-CLP4A	L4A	105.00	155.00	1	200	B30-R10000
B30-262-7569-CLP4B	L4B	105.00	155.00	1	200	B30-R10000



i You can find out sign and label printers from page 236 onwards.

i Visit www.bradyeurope.com for further information or contact your local Brady distributor.

These pages show the signs used for transporting hazardous materials. The symbols and colours attributed based on the risk category of the merchandise make it possible to quickly identify the type of hazard.

ADR LEGISLATION-COMPLIANT TRANSPORT SIGNAGE

For ADR signs 1, 1.4, 1.5 and 1.6, please indicate the following when placing the order:

* division ** compatibility group



ADR 2.1A - CLASS 2 : NON-FLAMMABLE, FLAMMABLE GASES



Order Ref.	Width (mm)	Height (mm)	Legend	Total Qty/Pack
Magnetic Plastic				
227591	297	297	2	1 Sign(s) / Card
Laminated Polyester				
227587	100	100	2	1 Sign(s) / Card
227590	100	100	2	250 Sign(s) / Roll
227588	200	200	2	1 Sign(s) / Card
227589	297	297	2	1 Sign(s) / Card
Aluminium				
227592	297	297	2	1 Sign(s) / Card

ADR 2.1B - CLASS 2 : NON-FLAMMABLE, FLAMMABLE GASES



Order Ref.	Width (mm)	Height (mm)	Legend	Total Qty/Pack
Magnetic Plastic				
223599	297	297	2	1 Sign(s) / Card
Laminated Polyester				
223561	100	100	2	1 Sign(s) / Card
223601	100	100	2	250 Sign(s) / Roll
223562	200	200	2	1 Sign(s) / Card
223563	297	297	2	1 Sign(s) / Card
Aluminium				
223600	297	297	2	1 Sign(s) / Card

ADR 2.3 - CLASS 2 : NON-FLAMMABLE, FLAMMABLE GASES



Order Ref.	Width (mm)	Height (mm)	Legend	Total Qty/Pack
Magnetic Plastic				
227795	297	297	2	1 Sign(s) / Card
Laminated Polyester				
227791	100	100	2	1 Sign(s) / Card
227794	100	100	2	250 Sign(s) / Roll
227792	200	200	2	1 Sign(s) / Card
227793	297	297	2	1 Sign(s) / Card
Aluminium				
227796	297	297	2	1 Sign(s) / Card

ADR 3B - CLASS 3 : FLAMMABLE LIQUIDS



Order Ref.	Width (mm)	Height (mm)	Legend	Total Qty/Pack
Magnetic Plastic				
223602	297	297	3	1 Sign(s) / Card
Laminated Polyester				
223564	100	100	3	1 Sign(s) / Card
223604	100	100	3	250 Sign(s) / Roll
223565	200	200	3	1 Sign(s) / Card
223566	297	297	3	1 Sign(s) / Card
Aluminium				
223603	297	297	3	1 Sign(s) / Card

ADR 4.2 - CLASS 4 : FLAMMABLE SOLID SUBSTANCES



Order Ref.	Width (mm)	Height (mm)	Legend	Total Qty/Pack
Magnetic Plastic				
258952	297	297	4	1 Sign(s) / Card
Laminated Polyester				
257508	100	100	4	1 Sign(s) / Card
223577	100	100	4	250 Sign(s) / Roll
257509	200	200	4	1 Sign(s) / Card
257576	297	297	4	1 Sign(s) / Card
Aluminium				
258953	297	297	4	1 Sign(s) / Card

ADR 2.1B - CLASS 2 : NON-FLAMMABLE, FLAMMABLE GASES



Order Ref.	Width (mm)	Height (mm)	Legend	Total Qty/Pack
Magnetic Plastic				
227597	297	297	2	1 Sign(s) / Card
Laminated Polyester				
227593	100	100	2	1 Sign(s) / Card
227596	100	100	2	250 Sign(s) / Roll
227594	200	200	2	1 Sign(s) / Card
227595	297	297	2	1 Sign(s) / Card
Aluminium				
227598	297	297	2	1 Sign(s) / Card

ADR 2.2B - CLASS 2 : NON-FLAMMABLE, FLAMMABLE GASES



Order Ref.	Width (mm)	Height (mm)	Legend	Total Qty/Pack
Magnetic Plastic				
258943	297	297	2	1 Sign(s) / Card
Laminated Polyester				
257502	100	100	2	1 Sign(s) / Card
223574	100	100	2	250 Sign(s) / Roll
257503	200	200	2	1 Sign(s) / Card
257573	297	297	2	1 Sign(s) / Card
Aluminium				
258944	297	297	2	1 Sign(s) / Card

ADR 3A - CLASS 3 : FLAMMABLE LIQUIDS



Order Ref.	Width (mm)	Height (mm)	Legend	Total Qty/Pack
Magnetic Plastic				
258946	297	297	3	1 Sign(s) / Card
Laminated Polyester				
257504	100	100	3	1 Sign(s) / Card
223575	100	100	3	250 Sign(s) / Roll
257505	200	200	3	1 Sign(s) / Card
257574	297	297	3	1 Sign(s) / Card
Aluminium				
258947	297	297	3	1 Sign(s) / Card

ADR 4.1 - CLASS 4 : FLAMMABLE SOLID SUBSTANCES



Order Ref.	Width (mm)	Height (mm)	Legend	Total Qty/Pack
Magnetic Plastic				
258949	297	297	4	1 Sign(s) / Card
Laminated Polyester				
257506	100	100	4	1 Sign(s) / Card
223576	100	100	4	250 Sign(s) / Roll
257507	200	200	4	1 Sign(s) / Card
257575	297	297	4	1 Sign(s) / Card
Aluminium				
258950	297	297	4	1 Sign(s) / Card

ADR 4.3 - CLASS 4 : FLAMMABLE SOLID SUBSTANCES



Order Ref.	Width (mm)	Height (mm)	Legend	Total Qty/Pack
Magnetic Plastic				
258955	297	297	4	1 Sign(s) / Card
Laminated Polyester				
257510	100	100	4	1 Sign(s) / Card
223578	100	100	4	250 Sign(s) / Roll
257511	200	200	4	1 Sign(s) / Card
257577	297	297	4	1 Sign(s) / Card
Aluminium				
258956	297	297	4	1 Sign(s) / Card

ADR 4.3B - CLASS 4 : FLAMMABLE SOLID SUBSTANCES



Order Ref.	Width (mm)	Height (mm)	Legend	Total Qty/Pack
Magnetic Plastic				
223605	297	297	4	1 Sign(s) / Card
Laminated Polyester				
223567	100	100	4	1 Sign(s) / Card
223607	100	100	4	250 Sign(s) / Roll
223568	200	200	4	1 Sign(s) / Card
223569	297	297	4	1 Sign(s) / Card
Aluminium				
223606	297	297	4	1 Sign(s) / Card



For ADR Packaging Labels, see page 229, 230.

ADR LEGISLATION-COMPLIANT TRANSPORT SIGNAGE

ADR 5.2 - CLASS 5 : OXYDIZING SUBSTANCES AND ORGANIC PEROXIDES



Order Ref.	Width (mm)	Height (mm)	Legend	Total Qty/Pack
Magnetic Plastic				
810938	200	200	5.2	1 Sign(s) / Card
Laminated Polyester				
810934	100	100	5.2	1 Sign(s) / Card
810935	100	100	5.2	250 Sign(s) / Roll
810936	200	200	5.2	1 Sign(s) / Card
810937	297	297	5.2	1 Sign(s) / Card
Aluminium				
810939	200	200	5.2	1 Sign(s) / Card

ADR 6.1 - CLASS 6 : TOXIC AND HARMFUL SUBSTANCES



Order Ref.	Width (mm)	Height (mm)	Legend	Total Qty/Pack
Magnetic Plastic				
258967	297	297	6	1 Sign(s) / Card
Laminated Polyester				
257518	100	100	6	1 Sign(s) / Card
223582	100	100	6	250 Sign(s) / Roll
257519	200	200	6	1 Sign(s) / Card
257581	297	297	6	1 Sign(s) / Card
Aluminium				
258968	297	297	6	1 Sign(s) / Card

ADR 8 - CLASS 8 : CORROSIVE SUBSTANCES



Order Ref.	Width (mm)	Height (mm)	Legend	Total Qty/Pack
Magnetic Plastic				
258976	297	297	8	1 Sign(s) / Card
Laminated Polyester				
257524	100	100	8	1 Sign(s) / Card
223585	100	100	8	250 Sign(s) / Roll
257525	200	200	8	1 Sign(s) / Card
257584	297	297	8	1 Sign(s) / Card
Aluminium				
258977	297	297	8	1 Sign(s) / Card

ADR 9 - CLASS 9 : MISCELLANEOUS HAZARDOUS SUBSTANCES



Order Ref.	Width (mm)	Height (mm)	Legend	Total Qty/Pack
Magnetic Plastic				
258979	297	297	9	1 Sign(s) / Card
Laminated Polyester				
257526	100	100	9	1 Sign(s) / Card
223586	100	100	9	250 Sign(s) / Roll
257527	200	200	9	1 Sign(s) / Card
257585	297	297	9	1 Sign(s) / Card
Aluminium				
258980	297	297	9	1 Sign(s) / Card

IMDG LEGISLATION-COMPLIANT TRANSPORT SIGNAGE

IMDG MARITIME TRANSPORT SIGN - CLASS 9



Order Ref.	Width (mm)	Height (mm)	Total Qty/Pack
Magnetic Plastic			
198517	297	297	1 Sign(s) / Pack
Laminated Polyester			
198518	100	100	1 Sign(s) / Pack
198519	100	100	250 Sign(s) / Roll
198520	200	200	1 Sign(s) / Pack
198521	297	297	1 Sign(s) / Pack
Aluminium			
198522	297	297	1 Sign(s) / Pack

IMDG MARITIME TRANSPORT SIGN - HIGH TEMPERATURE



Order Ref.	Width (mm)	Height (mm)	Total Qty/Pack
Magnetic Plastic			
251641	250	217	1 Sign(s) / Card

ADR 5.1 - CLASS 5 : OXYDIZING SUBSTANCES AND ORGANIC PEROXIDES



Order Ref.	Width (mm)	Height (mm)	Legend	Total Qty/Pack
Magnetic Plastic				
258961	297	297	5.1	1 Sign(s) / Card
Laminated Polyester				
257514	100	100	5.1	1 Sign(s) / Card
223580	100	100	5.1	250 Sign(s) / Roll
257515	200	200	5.1	1 Sign(s) / Card
257579	297	297	5.1	1 Sign(s) / Card
Aluminium				
258962	297	297	5.1	1 Sign(s) / Card

ADR 5.2 - CLASS 5 : OXYDIZING SUBSTANCES AND ORGANIC PEROXIDES



Order Ref.	Width (mm)	Height (mm)	Legend	Total Qty/Pack
Magnetic Plastic				
810944	200	200	5.2	1 Sign(s) / Card
Laminated Polyester				
810940	100	100	5.2	1 Sign(s) / Card
810941	100	100	5.2	250 Sign(s) / Roll
810942	200	200	5.2	1 Sign(s) / Card
Aluminium				
810945	200	200	5.2	1 Sign(s) / Card

ADR 6.2 - CLASS 6 : TOXIC AND HARMFUL SUBSTANCES



Order Ref.	Width (mm)	Height (mm)	Legend	Total Qty/Pack
Magnetic Plastic				
258970	297	297	6	1 Sign(s) / Card
Laminated Polyester				
257534	100	100	6	1 Sign(s) / Card
223583	100	100	6	250 Sign(s) / Roll
257535	200	200	6	1 Sign(s) / Card
257536	297	297	6	1 Sign(s) / Card
Aluminium				
258971	297	297	6	1 Sign(s) / Card

ADR EHS - Class 9 : Miscellaneous hazardous substances



Order Ref.	Width (mm)	Height (mm)	Total Qty/Pack
Magnetic Plastic			
813603	297	297	1 Sign(s) / Card
Laminated Polyester			
813599	100	100	1 Sign(s) / Card
813604	100	100	250 Sign(s) / Roll
813600	200	200	1 Sign(s) / Card
813602	297	297	1 Sign(s) / Card
Aluminium			
813601	297	297	1 Sign(s) / Card

ADR-9A-LBM - Class 9 : Miscellaneous hazardous substances



Order Ref.	Width (mm)	Height (mm)	Total Qty/Pack
Magnetic Plastic			
198517	297	297	1 Sign(s) / Pack
Laminated Polyester			
198518	100	100	1 Sign(s) / Pack
198519	100	100	250 Sign(s) / Roll
198520	200	200	1 Sign(s) / Pack
198521	297	297	1 Sign(s) / Pack
Aluminium			
198522	297	297	1 Sign(s) / Pack

PIC 490 - SUPER HEAVY



Order Ref.	Width (mm)	Height (mm)	Legend	Total Qty/Pack
Laminated Polyester				
195995	250	217	SUPER HEAVY	1 Sign(s) / Pack



Other signage and accessories

Public information.....	226
Symbol labels	228
Packaging labels.....	229
Temperature indicating labels	231
Other signage and accessories	233



PUBLIC INFORMATION

Use these information signs to make it easier for your employees and visitors to move around your premises.

PIC 292 – DISABLED ACCESS



Order Ref.	Width (mm)	Height (mm)	Total Qty/Pack
Laminated Polyester			
251290	200	200	1 Sign(s) / Card
Polypropylene			
252307	200	200	1 Sign(s) / Card

PIC 453 – DISABLED ACCESS



Order Ref.	Width (mm)	Height (mm)	Total Qty/Pack
Laminated Polyester			
250553	200	200	1 Sign(s) / Card
Polypropylene			
252553	200	200	1 Sign(s) / Card

PIC 293 – INFORMATION



Order Ref.	Width (mm)	Height (mm)	Total Qty/Pack
Laminated Polyester			
251291	200	200	1 Sign(s) / Card
Polypropylene			
252308	200	200	1 Sign(s) / Card

PUBLIC INFORMATION



Order Ref.	Width (mm)	Height (mm)	Total Qty/Pack
Laminated Polyester			
250551	200	200	1 Sign(s) / Card
Polypropylene			
252551	200	200	1 Sign(s) / Card

PIC 452 – DRINKING WATER



Order Ref.	Width (mm)	Height (mm)	Total Qty/Pack
Laminated Polyester			
250552	200	200	1 Sign(s) / Card
Polypropylene			
252552	200	200	1 Sign(s) / Card

PIC 454 – PARKING



Order Ref.	Width (mm)	Height (mm)	Total Qty/Pack
Laminated Polyester			
250554	200	200	1 Sign(s) / Card
Polypropylene			
252554	200	200	1 Sign(s) / Card

PIC 455 – DIRECTION ARROW



Order Ref.	Width (mm)	Height (mm)	Total Qty/Pack
Laminated Polyester			
250555	200	200	1 Sign(s) / Card
Polypropylene			
252555	200	200	1 Sign(s) / Card

PIC 456 – ENTRANCE



Order Ref.	Width (mm)	Height (mm)	Total Qty/Pack
Laminated Polyester			
250556	200	200	1 Sign(s) / Card
Polypropylene			
252556	200	200	1 Sign(s) / Card

PIC 458 - TELEPHONE



Order Ref.	Width (mm)	Height (mm)	Total Qty/Pack
Laminated Polyester			
250558	200	200	1 Sign(s) / Card
Polypropylene			
252558	200	200	1 Sign(s) / Card

PIC 459 - TELEPHONE (RIGHT)



Order Ref.	Width (mm)	Height (mm)	Layout	Total Qty/Pack
Laminated Polyester				
250559	150	75	Portrait	1 Sign(s) / Card
Polypropylene				
250560	297	148	Portrait	1 Sign(s) / Card
252559	297	148	Portrait	1 Sign(s) / Card

PIC 460 – CAFETERIA



Order Ref.	Width (mm)	Height (mm)	Total Qty/Pack
Laminated Polyester			
250561	200	200	1 Sign(s) / Card
Polypropylene			
252560	200	200	1 Sign(s) / Card

PIC 461 – STAIRS

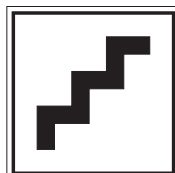

Order Ref.	Width (mm)	Height (mm)	Total Qty/Pack
Laminated Polyester			
250562	200	200	1 Sign(s) / Card
Polypropylene			
252561	200	200	1 Sign(s) / Card

PUBLIC INFORMATION

PIC 463 - LIFT

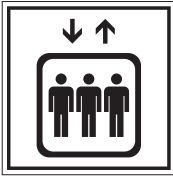

Order Ref.	Width (mm)	Height (mm)	Total Qty/Pack
Laminated Polyester			
250564	200	200	1 Sign(s) / Card
Polypropylene			
252563	200	200	1 Sign(s) / Card

PIC 468 – USE HANDRAIL



Order Ref.	Width (mm)	Height (mm)	Total Qty/Pack
Laminated Polyester			
223696	200	200	1 Sign(s) / Card
Polypropylene			
223697	200	200	1 Sign(s) / Card

PIC 469 – USE HANDRAIL



Order Ref.	Width (mm)	Height (mm)	Total Qty/Pack
Laminated Polyester			
223698	200	200	1 Sign(s) / Card
Polypropylene			
223699	200	200	1 Sign(s) / Card

PIC 470 – USE HANDRAIL



Order Ref.	Width (mm)	Height (mm)	Total Qty/Pack
Laminated Polyester			
223704	200	200	1 Sign(s) / Card
Polypropylene			
223705	200	200	1 Sign(s) / Card

PIC 466 – MEN'S WC



Order Ref.	Width (mm)	Height (mm)	Layout	Total Qty/Pack
Laminated Polyester				
250567	75	150	Portrait	1 Sign(s) / Card
Polypropylene				
252566	75	150	Portrait	1 Sign(s) / Card

PIC 465 – WOMEN'S WC



Order Ref.	Width (mm)	Height (mm)	Layout	Total Qty/Pack
Laminated Polyester				
250566	75	150	Portrait	1 Sign(s) / Card
Polypropylene				
252565	75	150	Portrait	1 Sign(s) / Card

PIC 901 – ELECTRONIC CIGARETTES PERMITTED



Order Ref.	Width (mm)	Height (mm)	Layout	Legend	Total Qty/Pack
Laminated Polyester					
138492	100	100	–	–	1 Sign(s) / Pack
138493	200	200	–	–	1 Sign(s) / Pack
138496	210	297	Portrait	Electronic cigarettes allowed	1 Sign(s) / Pack
Polypropylene					
138494	100	100	–	–	1 Sign(s) / Pack
138495	200	200	–	–	1 Sign(s) / Pack
138501	210	297	Portrait	Electronic cigarettes allowed	1 Sign(s) / Pack

Other signage

SYMBOL LABELS

WEEE AND RoHS COMPLIANT LABELS

The introduction of two directives, WEEE (waste electrical and electronic equipment) and the RoHS (Restriction of Certain Hazardous Substances), have had an impact on a number of industrial sectors. The labels below will help you identify products that comply with these directives.

WEEE - BLACK



Order Ref.	Width (mm)	Height (mm)	Total Qty/Pack
Laminated Polyester			
805532	10	13	500 Label(s) / Roll
805533	10	13	5000 Label(s) / Roll
805534	15	20	500 Label(s) / Roll
805535	15	20	5000 Label(s) / Roll

WEEE - WHITE



Order Ref.	Width (mm)	Height (mm)	Total Qty/Pack
Laminated Polyester			
805809	10	13	5000 Label(s) / Roll
805870	10	13	500 Label(s) / Roll
805810	15	20	500 Label(s) / Roll
805811	15	20	5000 Label(s) / Roll

UNLEADED



Order Ref.	Diameter (mm)	Total Qty/Pack
Laminated Polyester		
805794	15	500 Label(s) / Roll
805795	15	5000 Label(s) / Roll

ROHS COMPLIANT



Order Ref.	Width (mm)	Height (mm)	Total Qty/Pack
Laminated Polyester			
805792	30	10	500 Label(s) / Roll
805793	30	10	5000 Label(s) / Roll

LEAD FREE



Order Ref.	Width (mm)	Height (mm)	Total Qty/Pack
Laminated Polyester			
805790	30	10	500 Label(s) / Roll
805791	30	10	5000 Label(s) / Roll

SYMBOL LABELS

All electronic and electrical products sold in China must feature special signage indicating the type of hazardous materials they contain. These markings vary according to the amount of pollutant materials contained in the product, above or below the EU-RoHS limit values.

ROHS – EPUP-10



Order Ref.	Diameter (mm)	Colour	Total Qty/Pack
Polyester			
806619	10	Orange on White	1000 Label(s) / Roll
806620	10	Orange on White	5000 Label(s) / Roll
806621	10	Orange on Clear	1000 Label(s) / Roll
806622	10	Orange on Clear	5000 Label(s) / Roll
806635	15	Orange on White	1000 Label(s) / Roll
806636	15	Orange on White	5000 Label(s) / Roll
806637	15	Orange on Clear	1000 Label(s) / Roll
806638	15	Orange on Clear	5000 Label(s) / Roll
806651	20	Orange on White	1000 Label(s) / Roll
806652	20	Orange on White	5000 Label(s) / Roll
806653	20	Orange on Clear	1000 Label(s) / Roll
806654	20	Orange on Clear	5000 Label(s) / Roll
806667	30	Orange on White	1000 Label(s) / Roll
806668	30	Orange on White	5000 Label(s) / Roll
806669	30	Orange on Clear	1000 Label(s) / Roll
806670	30	Orange on Clear	5000 Label(s) / Roll

ROHS – EPUP-25



Order Ref.	Diameter (mm)	Colour	Total Qty/Pack
Polyester			
806623	10	Orange on White	1000 Label(s) / Roll
806624	10	Orange on White	5000 Label(s) / Roll
806625	10	Orange on Clear	1000 Label(s) / Roll
806626	10	Orange on Clear	5000 Label(s) / Roll
806639	15	Orange on White	1000 Label(s) / Roll
806640	15	Orange on White	5000 Label(s) / Roll
806641	15	Orange on Clear	1000 Label(s) / Roll
806642	15	Orange on Clear	5000 Label(s) / Roll
806655	20	Orange on White	1000 Label(s) / Roll
806656	20	Orange on White	5000 Label(s) / Roll
806657	20	Orange on Clear	1000 Label(s) / Roll
806658	20	Orange on Clear	5000 Label(s) / Roll
806671	30	Orange on White	1000 Label(s) / Roll
806672	30	Orange on White	5000 Label(s) / Roll
806673	30	Orange on Clear	1000 Label(s) / Roll
806674	30	Orange on Clear	5000 Label(s) / Roll

ROHS – EPUP-50



Order Ref.	Diameter (mm)	Colour	Total Qty/Pack
Polyester			
806627	10	Orange on White	1000 Label(s) / Roll
806628	10	Orange on White	5000 Label(s) / Roll
806629	10	Orange on Clear	1000 Label(s) / Roll
806630	10	Orange on Clear	5000 Label(s) / Roll
806643	15	Orange on White	1000 Label(s) / Roll
806644	15	Orange on White	5000 Label(s) / Roll
806645	15	Orange on Clear	1000 Label(s) / Roll
806646	15	Orange on Clear	5000 Label(s) / Roll
806659	20	Orange on White	1000 Label(s) / Roll
806660	20	Orange on White	5000 Label(s) / Roll
806661	20	Orange on Clear	1000 Label(s) / Roll
806662	20	Orange on Clear	5000 Label(s) / Roll
806675	30	Orange on White	1000 Label(s) / Roll
806676	30	Orange on White	5000 Label(s) / Roll
806677	30	Orange on Clear	1000 Label(s) / Roll
806678	30	Orange on Clear	5000 Label(s) / Roll

ROHS – E-SYMBOL



Order Ref.	Diameter (mm)	Colour	Total Qty/Pack
Polyester			
806615	10	Green on White	1000 Label(s) / Roll
806616	10	Green on White	5000 Label(s) / Roll
806617	10	Green on Clear	1000 Label(s) / Roll
806618	10	Green on Clear	5000 Label(s) / Roll
806631	15	Green on White	1000 Label(s) / Roll
806632	15	Green on White	5000 Label(s) / Roll
806633	15	Green on Clear	1000 Label(s) / Roll
806634	15	Green on Clear	5000 Label(s) / Roll
806647	20	Green on White	1000 Label(s) / Roll
806648	20	Green on White	5000 Label(s) / Roll
806649	20	Green on Clear	1000 Label(s) / Roll
806650	20	Green on Clear	5000 Label(s) / Roll
806663	30	Green on White	1000 Label(s) / Roll
806664	30	Green on White	5000 Label(s) / Roll
806665	30	Green on Clear	1000 Label(s) / Roll
806666	30	Green on Clear	5000 Label(s) / Roll

SYMBOL LABELS

CE Logo

EC marking stipulates that the product was designed and manufactured in accordance with European requirements on health, safety and the environment.

PIC 467 - CE LOGO



Order Ref.	Diameter (mm)	Legend	Total Qty/Pack
Laminated Polyester			
250568	25	CE	7 Sign(s) / Card
251965	25	CE	250 Sign(s) / Roll
223333	50	CE	250 Sign(s) / Roll
223334	100	CE	250 Sign(s) / Roll

PIC 467 - CE LOGO



Order Ref.	Width (mm)	Height (mm)	Legend	Total Qty/Pack
Laminated Polyester				
250569	37	18	CE	10 Sign(s) / Card
250570	74	37	CE	5 Sign(s) / Card

SYMBOL LABELS

This symbol indicates an anti-deflagration product.

PIC 1521 - EX LOGO



Order Ref.	Diameter (mm)	Shape	Total Qty/Pack
Laminated Polyester			
803996	15	Hexagon	250 Sign(s) / Roll
803997	20	Hexagon	250 Sign(s) / Roll

PACKAGING LABELS



Visible messages immediately indicate the precautions to be taken in sending your fragile packages in complete security.

ADR LQ Y



Order Ref.	Width (mm)	Height (mm)	Legend	Total Qty/Pack
Laminated Polyester				
813993	100	100	Y	250 Sign(s) / Roll

ADR LQ

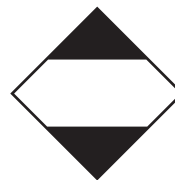

Order Ref.	Width (mm)	Height (mm)	Total Qty/Pack
Laminated Polyester			
813992	100	100	250 Sign(s) / Roll

ADR QE



Order Ref.	Width (mm)	Height (mm)	Legend	Total Qty/Pack
Laminated Polyester				
813994	100	100	QE	1 Sign(s) / Card

PIC 10 - KEEP DRY



Order Ref.	Width (mm)	Height (mm)	Layout	Total Qty/Pack
Laminated Polyester				
257528	74	105	Landscape	1 Sign(s) / Card
257529	148	210	Portrait	1 Sign(s) / Card

PIC 011 - KEEP UPRIGHT

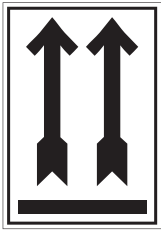

Order Ref.	Width (mm)	Height (mm)	Layout	Total Qty/Pack
Laminated Polyester				
257530	74	105	Landscape	1 Sign(s) / Card
257531	148	210	Portrait	1 Sign(s) / Card

PIC 12 - FRAGILE



Order Ref.	Width (mm)	Height (mm)	Layout	Total Qty/Pack
Laminated Polyester				
257532	74	105	Landscape	1 Sign(s) / Card
257533	148	210	Portrait	1 Sign(s) / Card

STE 13 - HANDLE WITH CARE



Order Ref.	Width (mm)	Height (mm)	Layout	Legend	Total Qty/Pack
Laminated Polyester					
251642	148	210	Portrait	Handle with care	1 Sign(s) / Card

STE 14 : FRAGILE



Order Ref.	Width (mm)	Height (mm)	Layout	Legend	Total Qty/Pack
Laminated Polyester					
251643	148	210	Portrait	Fragile	1 Sign(s) / Card

STE 15 - FRAGILE KEEP DRY



Order Ref.	Width (mm)	Height (mm)	Layout	Legend	Total Qty/Pack
Laminated Polyester					
251644	148	210	Portrait	Fragile Keep dry	1 Sign(s) / Card

STE 16 : DO NOT STACK



Order Ref.	Width (mm)	Height (mm)	Layout	Legend	Total Qty/Pack
Laminated Polyester					
251645	148	210	Portrait	Do not stack	1 Sign(s) / Card

ADR-LBM - LBM - Lithium Battery Mark



Order Ref.	Width (mm)	Height (mm)	Total Qty/Pack
Laminated Polyester			
198504	105	74	10 Sign(s) / Pack
198503	120	110	10 Sign(s) / Pack

ADR-LBM - LBM - Lithium Battery Mark - Customisable



Order Ref.	Width (mm)	Height (mm)	Total Qty/Pack
Laminated Polyester			
198506	105	74	10 Sign(s) / Pack
198505	120	110	10 Sign(s) / Pack

REVERSIBLE TEMPERATURE INDICATORS

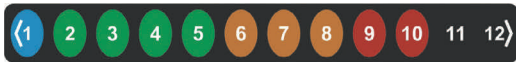

IRREVERSIBLE TEMPERATURE INDICATORS



TEMPERATURE INDICATING LABELS

REVERSIBLE AND IRREVERSIBLE TEMPERATURE INDICATING LABELS

Temperature indicating labels form an economical solution for controlling temperature during maintenance operations or for detecting errors during research and development procedures. The extremely small size of indicators means they can be applied on components, industrial and domestic appliances such as electrical pumps, rotating equipment, brakes and refrigerators, cold chain systems and hot environments, or in areas where measuring the temperature proves difficult or impractical. Brady offers both reversible and irreversible temperature indicators.



Quick, easy and economical

- Instant response over a large reading area
- Absence of battery or glass
- Continuous monitoring, even in the event of power cut
- Powerful adhesive for all surfaces

Reversible temperature indicating labels

- Change of colour at specific temperatures
- Temperature ranges between 0 – 100°C
- Highly customisable

Irreversible temperature indicating labels

- Permanent indication of the temperature
- Colour change when a predefined temperature is reached
- Highly customisable

The temperature indicating labels must be applied preferably on a dry clean surface for maximum efficiency. In tandem, their powerful adhesive minimises the risk of labels coming unstuck, even on dirty or uneven surfaces.

BRADY
Customise-it

CUSTOMISED TEMPERATURE INDICATING LABELS

Other ranges of temperatures, sizes and customised designs are available on demand, subject to a minimum order quantity.

REVERSIBLE TEMPERATURE INDICATORS

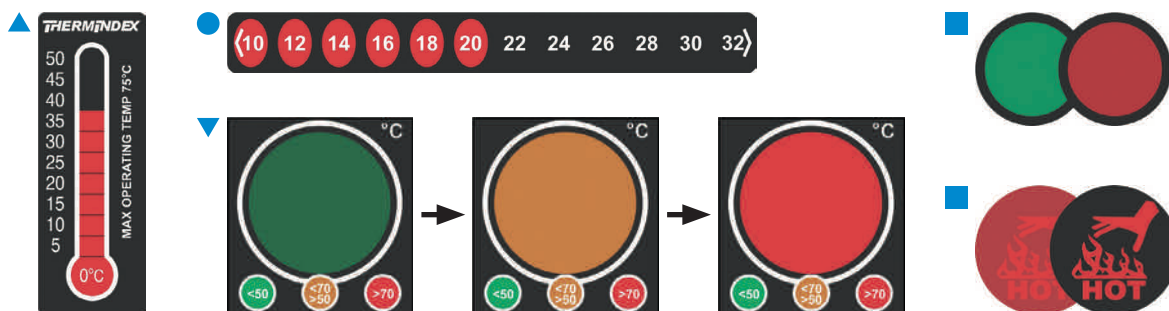

Order Ref.	Description	Width (mm)	Height (mm)	Diameter (mm)	Total Qty/Pack
▲ 195837	0 - 50°C Max Operating Temp 75°C	18.00	51.00	–	10 Label(s) / Pack
▲ 195838	0 - 50°C Max Operating Temp 110°C	18.00	51.00	–	10 Label(s) / Pack
● 195839	10–32 °C	90.00	10.00	–	10 Label(s) / Pack
● 195840	1–12 °C	90.00	10.00	–	10 Label(s) / Pack
● 195841	2–8 °C	96.00	40.00	–	10 Label(s) / Pack
▼ 195842	50–70 °C	48.00	52.00	–	10 Label(s) / Pack
■ 195843	–	–	–	24.00	10 Label(s) / Pack
■ 195844	Hot	–	–	37.00	10 Label(s) / Pack

IRREVERSIBLE TEMPERATURE INDICATORS

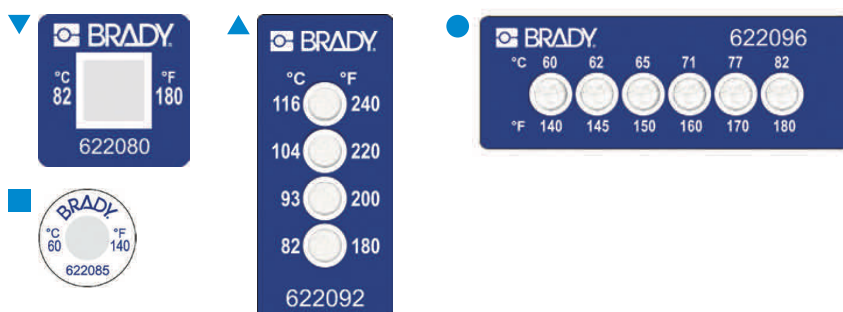

Order Ref.	Description	Width (mm)	Height (mm)	Diameter (mm)	Total Qty/Pack
▼ 622080	82°C/180°F	20.00	20.00	–	60 Label(s) / Pack
■ 622085	60°C/140°F	–	–	13.00	60 Label(s) / Pack
■ 622086	7°C/160°F	–	–	13.00	60 Label(s) / Pack
■ 622087	82°C/180°F	–	–	13.00	60 Label(s) / Pack
▲ 622092	82°C/180°F - 116°C/240°F	20.00	45.00	–	30 Label(s) / Pack
● 622095	37°C/100°F - 54°C/130°F	56.00	20.00	–	30 Label(s) / Pack
● 622096	60°C/140°F - 82°C/180°F	56.00	20.00	–	30 Label(s) / Pack
● 622097	88°C/190°F - 110°C/230°F	56.00	20.00	–	30 Label(s) / Pack
● 622098	116°C/240°F - 143°C/290°F	56.00	20.00	–	30 Label(s) / Pack
● 622099	149°C/300°F - 177°C/350°F	56.00	20.00	–	30 Label(s) / Pack
● 622100	180°C/360°F - 210°C/410°F	56.00	20.00	–	30 Label(s) / Pack

DOUBLE-SIDED ADHESIVE FOAM

The adhesive tape ensures guarantees the durability of the assembly and very strong adhesion capable of withstanding long exposure to UV and bad weather conditions. The adhesive tape adheres better to a clean, dry and cohesive surface. Exerting firm pressure on application will create better contact for the adhesive on the substrate and thus make the assembly stronger.

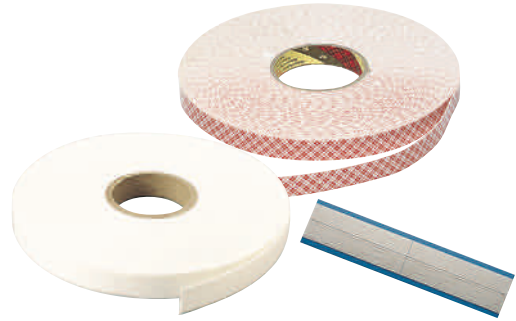

ON ROLLS

Order Ref.	Description	Height (mm)	Length (m)	Total Qty/Pack
078273	Bradyfoam Mounting Tape	19	33 m	1 Roll(s) / Roll
227599	Bradyfoam Mounting Tape	19	33 m	1 Roll(s) / Roll
019811	Bradyfoam Mounting Tape	25	33 m	1 Roll(s) / Roll

ON CARDS

Order Ref.	Description	Width (mm)	Height (mm)	Total Qty/Pack
097200	Bradyfoam Mounting Tape	19	114	4 Piece(s) / Card

OPEN/CLOSE ASSEMBLY SYSTEM

Open/close fasteners, fitted with high-performance adhesive making it possible to fix different materials such as metal, wood, glass and different plastics, making the following components immovable:

- safety signage
- information systems (plans, layouts, etc.)

Operating on the scratch principle, the translucent Dual Lock provides numerous advantages:

- Translucent, it is discreet and adapts to all colours of materials
- Fitted with a transparent, very high performance tape, it is fully resistant to external weather conditions (UV, damp, etc.)



Order Ref.	Description	Height (mm)	Length (m)	Total Qty/Pack
256456	Transparent Dual Lock Fasteners	25	5 m	2 Roll(s) / Pack

MAGNETIC STRIPS

- Adhesive side

Order Ref.	Description	Width (mm)	Height (mm)	Total Qty/Pack
058301	Magnetic Strips	100	25	10 Piece(s) / Pack





COLD-ENVIRONMENT DOUBLE-SIDED ADHESIVE TAPE

- Internal and external use
- Adhesive on both sides
- -57°C

Order Ref.	Description	Height (mm)	Length (m)	Total Qty/Pack
055717	Cold Temperature Mounting Strips	25	16 m	1 Roll(s) / Roll

COLOUR CABLE TIES



Order Ref.	Colour	Width (mm)	Size - Length (mm)	Total Qty/Pack
196309	Natural	2.50	98.00	100 Piece(s) / Pack
196310	Natural	3.50	140.00	100 Piece(s) / Pack
196311	Natural	3.50	200.00	100 Piece(s) / Pack
196314	Natural	4.80	200.00	100 Piece(s) / Pack
196320	Natural	4.80	390.00	100 Piece(s) / Pack

i Visit www.bradyeurope.com for more colours or contact your Brady distributor



SAFETY SIGN SLIDERS

Brady's new Safety Sign Sliders are visual communication platforms for your facility that will communicate your most important safety and awareness messages to facility visitors and employees.

You ensure that you are displaying the most relevant information for your facility or area so that anyone entering that area is aware of how to keep themselves and others safe. This new system utilises an interchangeable insert feature (signs slide in/out) so you can customise your messages specific to the area, and can make changes as needed quickly and cost-effectively.

Pre-printed inserts are available, standard or custom. You can also use blank boards and print yourself the sign and messaging. See page 198 for further information.



BLANK GLOW-IN-THE-DARK SIGN

To indicate extinguishers even in darkness.

Order Ref.	Width (mm)	Height (mm)	Material	Total Qty/Pack
812939	395	590	Polypropylene	1 Sign(s) / Pack



Sign and label printers

BBP™85 Sign and Label Printer	236
BradyJet J5000 Colour Label Printer	237
BBP™35 Multicolour Sign & Label Printer	
BBP™37 Multicolour & Cut Sign & Label Printer	238
Brady Workstation.....	238
BBP™30 and BBP™31 Sign and Label Printer	239
BMP™71 Label Printer.....	239

Sign and label printers



BBP™85 SIGN AND LABEL PRINTER

The BBP™85 Sign and Label Printer allows you to create up to 254.00 mm labels & signs in multiple colours. Its improved interface makes it easy to use for anyone.

- Highly durable multi-colour thermal transfer printing
- Simple touch-screen interface for stand-alone use, or print from your PC with MarkWare™ Facility Identification Software
- Timesaving label design apps to create pipe markers, safety signs, right-to-know labels and more
- The ideal printer for multi-user Lean, 5S and Kaizen Labelling events

Order Reference	Description
711190	BBP85 Sign and Label Printer QWERTZ with MarkWare Software
711191	BBP85 Sign and Label Printer CYRILLIC with MarkWare Software
711192	BBP85 Sign and Label Printer AZERTY with MarkWare Software
711193	BBP85 Sign and Label Printer QWERTY - EU with MarkWare Software
711194	BBP85 Sign and Label Printer QWERTY - UK with MarkWare Software



B-595 PRE-PRINTED PRE-CUT BLANK SIGN HEADERS

FOR CREATING ARC FLASH AND SAFETY WARNING LABELS IN SECONDS.

- Allows the printer to create multi-colour signs fast - in a single print pass
- Operating Temperature : -40 °C to 82 °C / Application Temperature : -18 °C to 82 °C
- Headers meet OSHA 1910.145 and ASME/ANSI Z535 standards
- Indoor/Outdoor grade material conforms to rough, irregular and "difficult to adhere to" surfaces

Fits Printer Model(s)	Order Reference	Width A (mm)	Height B (mm)	Labels per Roll	Recommended Ribbon	Diagram	
BBP85	B85-102x152-595-OSHACA		102.00	152.00	95	B85-R-158x60-BK	
BBP85	B85-178x254-595-OSHACA		178.00	254.00	60	B85-R-220x60-BK	
BBP85	B85-254x356-7569-OSHACA		254.00	356.00	40	B85-R-220x60-BK	
BBP85	B85-102x152-595-ANSICA		102.00	152.00	95	B85-R-158x60-BK	
BBP85	B85-178x254-595-ANSICA		178.00	254.00	60	B85-R-220x60-BK	
BBP85	B85-254x356-7569-ANSICA		254.00	356.00	40	B85-R-220x60-BK	
BBP85	B85-102x152-595-OSHADA		102.00	152.00	95	B85-R-158x60-BK	
BBP85	B85-178x254-595-OSHADA		178.00	254.00	60	B85-R-220x60-BK	
BBP85	B85-254x356-7569-OSHADA		254.00	356.00	40	B85-R-220x60-BK	
BBP85	B85-102x152-595-ANSIDA		102.00	152.00	95	B85-R-158x60-BK	
BBP85	B85-178x254-595-ANSIDA		178.00	254.00	60	B85-R-220x60-BK	
BBP85	B85-254x356-7569-ANSIDA		254.00	356.00	40	B85-R-220x60-BK	
BBP85	B85-102x152-595-ANSINO		102.00	152.00	95	B85-R-158x60-BK	
BBP85	B85-178x254-595-ANSINO		178.00	254.00	60	B85-R-220x60-BK	
BBP85	B85-254x356-7569-ANSINO		254.00	356.00	40	B85-R-220x60-BK	
BBP85	B85-102x152-595-ANSIWA		102.00	152.00	95	B85-R-158x60-BK	
BBP85	B85-178x254-595-ANSIWA		178.00	254.00	60	B85-R-220x60-BK	
BBP85	B85-254x356-7569-ANSIWA		254.00	356.00	40	B85-R-220x60-BK	
BBP85	B85-178x254-595-YL		178.00	254.00	60	B85-R-220x60-BK	
BBP85	B85-254x356-7569-YL		254.00	356.00	40	B85-R-220x60-BK	
BBP85	B85-178x254-595-WT		178.00	254.00	60	B85-R-220x60-BK	
BBP85	B85-254x356-7569-WT		254.00	356.00	40	B85-R-220x60-BK	



BRADYJET J5000 COLOUR LABEL PRINTER

The BradyJet J5000 Colour Label Printer enables you to create full colour indoor signs and labels on demand. These will help you to offer important safety and lean information right where employees need to see it.

Easily create the full colour labels and signs needed with the BradyJet J5000 Colour Label Printer to communicate safety information, procedures, facility identification and a variety of other applications to reduce workplace accidents and to increase productivity.

REDUCE ACCIDENTS

Use the BradyJet J5000 Colour Label Printer to immediately communicate about an identified hazard by creating safety signs, CLP/GHS labels, Lockout/Tagout tags, arc flash labels, fire visuals or machine hazard labels.

INCREASE PRODUCTIVITY

Use the BradyJet J5000 Colour Label Printer to print standard work procedures and waste management rules. Create machine operating procedures and attach them to machinery to increase efficiency on the workflow.

Identify passage ways, danger zones, departments and storage areas with clear colour coded signs so new employees and contractors don't lose time finding their way. Add PPE communication, steps to take in the event of a fire and evacuation plans.



Order Reference	Description
J5000-US	BradyJet J5000 Colour Label Printer - US
J5000-UK	BradyJet J5000 Colour Label Printer - UK
J5000-EU	BradyJet J5000 Colour Label Printer - EU



B-2595/B-2569 INKJET RECEPTIVE POLYESTER AND VINYL LABELS

The BradyJet J5000 Colour Label Printer prints on Brady's durable B-2595 vinyl and B-2569 polyester sign and label material range. These labels feature a topcoat that enhances the colour and label appearance, and protects your print from smudging and harsh conditions. The labels have been tested to withstand exposure to liquids, alcohol and chemicals. Available in sizes ranging from 55.00 to 203.20 mm for the BradyJet J5000 Colour Label Printer.

Easily print durable, full colour and high resolution tags at your location whenever you need them in Lockout/Tagout or other company procedures.

Applying laminates on your BradyJet signs and labels enables you to create full colour outdoor identification at location. Laminates add 3 year outdoor durability to signs or labels.



Diagram	Order Reference	Colour	Width A (mm)	Height B (mm)	Length B (m)	Labels per Roll
Acrylic						
∞	LAM-2250-910	Clear	70.00	-	36	1
∞	LAM-4000-910	Clear	114.00	-	36	1
∞	LAM-6000-910	Clear	165.00	-	36	1
∞	LAM-8000-910	Clear	216.00	-	36	1
Heavy Duty Polyester						
🔒	J50-255-2551	White	82.55	146.05	-	100
Inkjet Receptive Polyester						
∞	J50C-2250-2569	White	57.00	-	30	1
∞	J50C-4000-2569	White	101.00	-	30	1
∞	J50C-6000-2569	White	152.00	-	30	1
∞	J50C-8000-2569	White	203.20	-	30	1
▲	J50-260-2569	White	55.00	85.00	-	340
▲	J50-261-2569	White	75.00	110.00	-	270
▲	J50-262-2569	White	105.00	155.00	-	200
▲	J50-267-2569	White	155.00	210.00	-	120
▲	J50-265-2569	White	178.00	254.00	-	100
Inkjet Receptive Vinyl						
∞	J50C-2250-2595	White	57.00	-	30	1
∞	J50C-4000-2595	White	101.00	-	30	1
∞	J50C-6000-2595	White	152.00	-	30	1
∞	J50C-8000-2595	White	203.20	-	30	1
▲	J50-260-2595	White	55.00	85.00	-	340
▲	J50-261-2595	White	75.00	110.00	-	270
▲	J50-262-2595	White	105.00	155.00	-	200
▲	J50-267-2595	White	155.00	210.00	-	120
▲	J50-265-2595	White	178.00	254.00	-	100

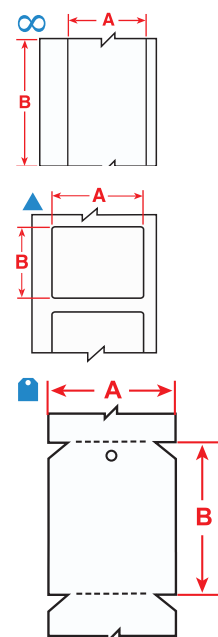

Sign and label printers

BBP™35 MULTICOLOUR SIGN & LABEL PRINTER

BBP™37 MULTICOLOUR & CUT SIGN & LABEL PRINTER

Because safety and productivity mean the world to you, it's time to step up to the new standard by creating signs and labels that demand attention. After all, effective workplace visuals make all the difference in taking your facility to the next level by giving employees the information they need right at a glance.

And now there's a tool to do it all!

Brady's BBP35 and BBP37 sign and label printers give you the power to make signs and labels in the colours and shapes you need to make an impact – right at your own facility and right when you need them. With remarkable multi-colour printing, versatile shape-cutting capabilities and impressively fast print speeds, you won't remember how you lived without one of these printers.



Order Reference	Description
143635	BBP35 Multicolour Sign and Label Printer AZERTY
143637	BBP35 Multicolour Sign and Label Printer CYRILLIC
143634	BBP35 Multicolour Sign and Label Printer QWERTY - EU
145996	BBP35 Multicolour Sign and Label Printer QWERTY - UK
143633	BBP35 Multicolour Sign and Label Printer QWERTY - US
143636	BBP35 Multicolour Sign and Label Printer QWERTZ

Order Reference	Description
143640	BBP37 Multicolour and Cut Sign and Label Printer AZERTY
143642	BBP37 Multicolour and Cut Sign and Label Printer CYRILLIC
143639	BBP37 Multicolour and Cut Sign and Label Printer QWERTY - EU
145995	BBP37 Multicolour and Cut Sign and Label Printer QWERTY - UK
143638	BBP37 Multicolour and Cut Sign and Label Printer QWERTY - US
143641	BBP37 Multicolour and Cut Sign and Label Printer QWERTZ

SIGN AND LABEL PRINTERS

FOR CREATING ARC FLASH AND SAFETY WARNING LABELS IN SECONDS

- Allows the printer to create multi-colour signs fast - in a single print pass
- Indoor/Outdoor grade material conforms to rough, irregular and "difficult to adhere to surfaces"
- Headers compliant with standards OSHA 910.145 and ASME/ANSI Z535
- Internal/external product suitable for rough and uneven surfaces on which adhesion is difficult



Order Reference		Size - Width A (mm)	Size - Height B (mm)	Labels per Row	Labels per Roll	Recommended Ribbon	Diagram
B30-25-595-ANSIDA		101.00	152.00	1	175	B30-R10000	⊗
B30-241-595-ANSIDA		57.00	75.00	1	300	B30-R10000	⊗
B30-25-595-ANSICA		101.00	152.00	1	175	B30-R10000	⊗
B30-241-595-ANSICA		57.00	75.00	1	300	B30-R10000	⊗
B30-25-595-ANSIWA		101.00	152.00	1	175	B30-R10000	⊗
B30-241-595-ANSIWA		57.00	75.00	1	300	B30-R10000	⊗
B30-25-595-ANSINO		101.00	152.00	1	175	B30-R10000	⊗
B30-241-595-ANSINO		57.00	75.00	1	300	B30-R10000	⊗
B30-25-595-OSHADA		101.00	152.00	1	175	B30-R10000	⊗
B30-241-595-OSHADA		57.00	75.00	1	300	B30-R10000	⊗
B30-25-595-OSHACA*		101.00	152.00	1	175	B30-R10000	⊗
B30-241-595-OSHACA*		57.00	75.00	1	300	B30-R10000	⊗
B30-25-595-BLNKWT		101.00	152.00	1	175	B30-R10000	▲
B30-241-595-BLNKWT		57.00	75.00	1	300	B30-R10000	▲
B30-242-595-BLNKWT		29.00	72.00	1	300	B30-R10000	▲
B30-219-595-BLNKWT		57.00	98.00	1	250	B30-R10000	▲
B30-25-595-BLNKYL		101.00	152.00	1	175	B30-R10000	▲
B30-241-595-BLNKYL		57.00	75.00	1	300	B30-R10000	▲

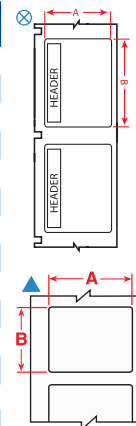

BRADY WORKSTATION

The latest in label creation software, Brady Workstation revolutionises the way you create labels on your PC. Instead of using a CD to upload label-making software on your computer, you simply download the Brady Workstation platform to your desktop and add the label-creation apps you want.

It's built to be simple, with a variety of easy-to-use apps for several applications. Each app walks you through the necessary steps to efficiently create your own signs, pipe markers, lockout procedures and labels, giving you time to spare for other projects. It also includes built-in regulations and standards to help you stay compliant.



i Discover it at www.bradyeurope.com/bradyworkstation



BBP™30 AND BBP™31 SIGN AND LABEL PRINTER

Designed for ease of use and versatility, this monochrome printer features an intuitive touch screen display, simple label design and a wide variety of materials and applications.

Coined as “2-step printing,” this printer enables anyone to create labels without prior training. Simply type the desired text and hit the print button. With true “walk-up-and-print” functionality, everything that needs to be labelled in a facility actually gets labelled.

- 300 dpi printing resolution
- Prints on labels and tapes from 12.70 wide to 101 mm wide

Order Reference	Description
710739	BBP31 Sign and Label Printer AZERTY
710740	BBP31 Sign and Label Printer CYRILLIC
710737	BBP31 Sign and Label Printer QWERTY - EU
710731	BBP31 Sign and Label Printer QWERTY - UK
710738	BBP31 Sign and Label Printer QWERTZ

Order Reference	Description
145998	BBP30 Sign and Label Printer - EU
145999	BBP30 Sign and Label Printer - UK

B-595 PRE-CUT AND PRE-PRINTED BLANK LABELS WITH HEADER

FOR CREATING MULTI-COLOUR ANSI AND OSHA SIGNS IN SECONDS



- Allows the printer to create multi-colour signs fast - in a single print pass
- Headers meet OSHA 1910.145 and ASME/ANSI Z535 standards
- Indoor/Outdoor grade material conforms to rough, irregular and “difficult to adhere to” surfaces
- Internal/external product suitable for rough and uneven surfaces on which adhesion is difficult



Order Reference		Size - Width A (mm)	Size - Height B (mm)	Labels per Row	Labels per Roll	Recommended Ribbon	Diagram
B30-25-595-ANSIDA		101.00	152.00	1	175	B30-R10000	
B30-241-595-ANSIDA		57.00	75.00	1	300	B30-R10000	
B30-25-595-ANSICA		101.00	152.00	1	175	B30-R10000	
B30-241-595-ANSICA		57.00	75.00	1	300	B30-R10000	
B30-25-595-ANSIWA		101.00	152.00	1	175	B30-R10000	
B30-241-595-ANSIWA		57.00	75.00	1	300	B30-R10000	
B30-25-595-ANSINO		101.00	152.00	1	175	B30-R10000	
B30-241-595-ANSINO		57.00	75.00	1	300	B30-R10000	
B30-25-595-OSHADA		101.00	152.00	1	175	B30-R10000	
B30-241-595-OSHADA		57.00	75.00	1	300	B30-R10000	
B30-25-595-OSHACA*		101.00	152.00	1	175	B30-R10000	
B30-241-595-OSHACA*		57.00	75.00	1	300	B30-R10000	
B30-25-595-BLNKWT		101.00	152.00	1	175	B30-R10000	
B30-241-595-BLNKWT		57.00	75.00	1	300	B30-R10000	
B30-242-595-BLNKWT		29.00	72.00	1	300	B30-R10000	
B30-219-595-BLNKWT		57.00	98.00	1	250	B30-R10000	
B30-25-595-BLNKYL		101.00	152.00	1	175	B30-R10000	
B30-241-595-BLNKYL		57.00	75.00	1	300	B30-R10000	

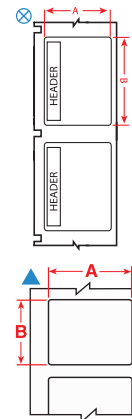

BMP™71 LABEL PRINTER

Brady's high-end portable label printer. Beside cable and wire printing solution for the telecom/datacom and electrical markets, the BMP71 is also perfect for printing health and safety signs and labels for the process industries.

The BMP71 is a user friendly printer with a large full colour LCD display, an easy-to-use menu driven user interface, and a full keyboard layout making it quick and easy to create labels using text, symbols and coding. It can be used as stand-alone unit, as well as PC connected.

- 300 dpi printing resolution
- Prints on labels and tapes up to 50.8 mm wide

Order Reference	Description
710599	BMP71 Label Printer - QWERTY EU
710600	BMP71 Label Printer - QWERTY UK
710601	BMP71 Label Printer - AZERTY
710603	BMP71 Label Printer - QWERTZ
710604	BMP71 Label Printer - CYRILLIC

This printer kit ships in a hard case with Rechargeable NiMH Battery, AC Adaptor, USB Communications Cable, TLS2200® / HandiMark™ Material Roll Adaptor, Quick Start Guide, Product CD (w/ Printer Driver, Tutorials, Full User's Guide), Cleaning Kit, M71C-2000-595-WT, M71-31-423 and M71-R6000.

Index by part number

Ref.	Page	Ref.	Page	Ref.	Page	Ref.	Page	Ref.	Page	Ref.	Page	Ref.	Page	Ref.	Page	Ref.	Page	Ref.	Page	Ref.	Page
019811	233	134823	39	134928	41	135044	43	135177	46	135293	48	135398	184	135508	186	135616	188	135724	190		
055717	234	134824	39	134931	41	135045	43	135178	46	135294	48	135399	184	135509	186	135617	188	135725	190		
058301	233	134825	39	134932	41	135046	43	135179	46	135295	48	135400	184	135510	186	135618	188	135729	190		
078273	233	134826	39	134933	41	135047	43	135180	46	135296	48	135401	184	135511	186	135621	188	135730	190		
097200	233	134827	39	134934	41	135049	43	135181	46	135297	48	135402	184	135512	186	135622	188	135731	190		
101386	83	134828	39	134935	41	135050	43	135184	46	135298	48	135408	184	135513	186	135623	188	135732	190		
121633	222	134829	39	134936	41	135051	44	135185	46	135299	48	135409	184	135514	186	135624	188	135733	190		
121634	222	134830	39	134937	41	135052	44	135186	46	135300	48	135410	184	135515	186	135625	188	135734	190		
121635	222	134834	39	134938	41	135056	44	135187	46	135301	48	135411	184	135516	186	135626	188	135735	190		
121636	222	134835	39	134939	41	135057	44	135188	46	135302	48	135412	184	135517	186	135627	188	135736	190		
121637	222	134836	39	134940	41	135058	44	135189	46	135303	48	135413	184	135518	186	135628	188	135737	190		
121638	222	134837	39	134943	41	135059	44	135190	46	135304	48	135414	184	135519	186	135629	188	135738	190		
121639	222	134838	39	134944	41	135061	44	135191	46	135305	48	135415	184	135520	186	135630	188	135739	190		
121640	222	134839	39	134945	41	135062	44	135192	46	135306	48	135416	184	135521	186	135631	188	135740	190		
121641	222	134840	39	134946	41	135063	44	135193	46	135307	48	135417	184	135522	186	135632	188	135741	119		
121642	222	134841	39	134947	41	135065	44	135196	46	135308	48	135418	184	135523	186	135633	188	135742	119		
121643	222	134842	39	134948	41	135066	44	135197	46	135312	48	135419	184	135524	186	135634	188	135743	119		
121644	222	134843	39	134949	41	135067	44	135198	46	135313	48	135420	184	135525	186	135635	188	135744	119		
121645	222	134844	39	134950	41	135070	44	135199	46	135314	48	135421	184	135526	186	135636	188	135745	119		
121646	222	134845	39	134951	42	135071	44	135200	46	135315	48	135425	184	135527	186	135637	188	135746	119		
121647	222	134846	40	134952	42	135073	44	135201	46	135316	48	135426	184	135528	186	135638	188	135747	119		
121648	222	134847	40	134955	42	135074	44	135202	46	135317	48	135427	184	135529	186	135639	188	135748	119		
121649	222	134848	40	134956	42	135075	44	135205	46	135318	48	135428	184	135533	186	135640	188	135749	119		
121650	222	134849	40	134957	42	135076	44	135210	46	135319	48	135429	184	135534	186	135644	188	135750	119		
130749	236	134850	40	134958	42	135077	44	135211	46	135320	48	135430	184	135535	186	135645	188	135751	119		
130750	236	134851	40	134959	42	135078	44	135214	46	135321	48	135431	184	135536	186	135646	188	135752	119		
130752	236	134852	40	134960	42	135079	44	135215	46	135322	48	135432	184	135537	186	135647	188	135753	119		
130753	236	134853	40	134961	42	135080	44	135216	46	135323	48	135433	184	135538	186	135648	188	135757	119		
130755	236	134854	40	134962	42	135083	44	135217	46	135324	48	135434	184	135539	186	135649	188	135758	119		
130756	236	134855	40	134963	42	135084	44	135218	46	135325	49	135435	184	135540	186	135650	188	135759	119		
130758	236	134856	40	134964	42	135085	44	135219	46	135326	49	135436	184	135541	186	135651	188	135760	119		
130759	236	134857	40	134967	42	135086	44	135220	46	135327	49	135437	185	135542	186	135652	188	135761	119		
130761	236	134861	40	134968	42	135087	44	135221	46	135328	49	135438	185	135543	186	135653	188	135762	119		
130762	236	134862	40	134969	42	135088	44	135222	47	135329	49	135439	185	135544	186	135654	188	135763	119		
130764	236	134863	40	134970	42	135089	44	135223	47	135330	49	135440	185	135545	187	135655	188	135764	119		
130765	236	134864	40	134971	42	135090	44	135226	47	135331	49	135441	185	135546	187	135656	188	135765	119		
132393	236	134865	40	134972	42	135091	44	135227	47	135332	49	135442	185	135549	187	135657	188	135766	119		
132395	236	134866	40	134973	42	135092	44	135228	47	135333	49	135443	185	135550	187	135658	188	135767	119		
134503	51	134867	40	134974	42	135095	44	135229	47	135334	49	135444	185	135551	187	135659	188	135768	144		
134504	51	134868	40	134975	42	135097	44	135230	47	135335	49	135445	185	135552	187	135660	188	135769	144		
134505	51	134869	40	134976	42	135098	44	135231	47	135339	49	135446	185	135553	187	135661	188	135770	144		
134656	14	134870	40	134979	42	135105	44	135232	47	135340	49	135447	185	135554	187	135662	188	135771	144		
134657	14	134871	40	134980	42	135106	44	135233	47	135341	49	135448	185	135555	187	135663	188	135772	144		
134658	14	134872	40	134981	42	135107	44	135234	47	135342	49	135455	185	135556	187	135664	188	135773	144		
134659	14	134873	40	134982	42	135108	44	135235	47	135343	49	135453	185	135557	187	135665	188	135774	144		
134664	22	134874	40	134983	42	135109	44	135238	47	135344	49	135454	185	135558	187	135666	188	135775	144		
134666	5	134875	40	134984	42	135110	45	135239	47	135345	49	135455	185	135561	187	135667	188	135776	144		
134668	22	134876	40	134985	42	135111	45	135240	47	135346	49	135456	185	135562	187	135671	189	135777	144		
134671	37	134877	40	134986	42	135115	45	135241	47	135347	49	135457	185	135563	187	135672	189	135778	144		
134672	37	134878	40	134987	42	135116	45	135242	47	135348	49	135458	185	135564	187	135673	189	135779	144		
134686	50	134879	40	134988	42	135117	45	135243	47	135349	49	135459	185	135565	187	135674	189	135783	144		
134687	50	134880	40	134991	42	135118	45	135244	47	135350	49	135460	185	135566	187	135675	189	135784	144		
134688	50	134881	40	134992	42	135119	45	135245	47	135351	49	135461	185	135567	187	135676	189	135785	144		
134689	51	134882	40	134993	42	135120	45	135246	47	135352	49	135462	185	135568	187	135677	189	135786	144		
134690	51	134883	40	134994	42	135127	45	135247	47	135353	49	135463	185	135569	187	135678	189	135787	144		
134692	51	134884	40	134995	42	135129	45	135250	47	135354	49	135464	185	135570	187	135679	189	135788	144		
134693	51	134888	40	134996	42	135130	45	135251	47	135355	49	135465	185	135573	187	135680	189	135789	144		
134695	51	134889	40	134997	42	135132	45	135252	47	135356	49	135466	185	135574	187	135681	189	135790	144		
134696	51	134890	40	134998	42	135135	45	135253	47	135357	49	135467	185	135575	187	135682	189	135791	144		
134697	51	134891	40	134999	43	135136	45	135254	47	135358	49	135468	185	135576	187	135683	190	135792	144		
134698	51	134892	40	135000	43	135137	45	135255	47	135359	49	135469	185	135577	187	135684	190	135793	144		
134700	51	134893	40	135003	43	135138	45	135256	47	135360											

Index by part number

Ref.	Page	Ref.	Page	Ref.	Page	Ref.	Page	Ref.	Page	Ref.	Page	Ref.	Page	Ref.	Page	Ref.	Page
135830	104	135935	62	136037	63	138859	13	139014	88	139477	212	145998	239	195055	210	195149	203
135831	104	135936	62	136038	63	138860	13	139015	95	139478	212	145999	239	195056	210	195150	203
135832	104	135937	62	136039	63	138863	12	139016	95	139479	212	148651	237	195057	210	195151	203
135833	104	135938	62	136040	63	138864	12	139017	90	139480	212	148652	237	195058	210	195152	204
135834	104	135939	62	136041	63	138865	12	139018	96	139481	212	148653	237	195059	210	195153	204
135838	104	135940	62	136042	63	138866	17	139019	96	139482	212	148654	237	195060	211	195154	204
135839	104	135941	62	136043	63	138867	17	139020	79	139483	216	148655	237	195061	211	195155	204
135840	104	135942	62	136044	63	138868	13	139021	79	139484	212	148656	237	195062	211	195156	204
135841	104	135943	62	136045	63	138869	13	139023	97	139485	212	148657	237	195063	211	195157	204
135842	104	135944	62	136046	63	138870	18	139024	75	139486	212	148658	237	195064	211	195158	204
135843	104	135945	62	136047	63	138871	18	139025	76	139487	212	148659	237	195065	211	195159	205
135844	104	135946	62	136048	64	138876	189	139026	74	139488	212	148660	237	195066	211	195160	203
135845	104	135947	62	136049	64	138878	82	139029	190	139489	213	148661	237	195067	211	195161	203
135846	104	135948	62	136050	64	138879	13	139072	190	139490	213	148662	237	195068	211	195162	203
135847	104	135949	62	136051	64	138880	13	139132	12	139491	213	148663	237	195069	211	195163	203
135848	104	135950	62	136052	64	138881	17	139133	12	139492	213	148664	237	195070	211	195164	203
135849	104	135951	62	136053	64	138882	17	139137	12	139493	213	148665	237	195071	211	195165	203
135850	61	135952	62	136054	64	138883	13	139138	12	139494	213	148666	237	195072	212	195166	203
135851	61	135953	62	136055	64	138884	13	139139	158	139495	213	148667	237	195073	212	195167	203
135852	61	135954	62	136056	64	138885	14	139140	171	139496	213	148668	237	195074	212	195168	203
135853	61	135955	62	136057	64	138886	17	139162	58	139497	213	148704	237	195075	212	195169	203
135854	61	135956	62	136058	64	138887	18	139163	58	139498	213	148791	237	195076	212	195170	203
135855	61	135957	62	136059	64	138894	119	139164	58	139499	213	148792	237	195077	212	195171	204
135856	61	135958	62	136063	64	138904	189	139212	12	139500	213	149232	237	195078	212	195172	204
135857	61	135959	62	136064	64	138913	13	139213	12	139501	214	149257	237	195079	216	195173	204
135858	61	135960	62	136065	64	138914	13	139214	12	139502	216	149258	237	195080	212	195174	204
135859	61	135964	62	136066	64	138915	17	139224	18	139503	216	149259	237	195081	212	195175	204
135860	61	135965	62	136067	64	138916	18	139240	17	139504	216	149260	237	195082	212	195176	204
135861	61	135966	62	136068	64	138917	18	139242	13	139505	216	194989	206	195083	212	195177	204
135865	61	135967	62	136069	64	138918	12	139244	58	139506	216	194990	206	195084	212	195178	204
135866	61	135968	62	136070	64	138919	12	139256	18	139507	216	194991	206	195085	213	195179	204
135867	61	135969	62	136071	64	138920	16	139257	59	139508	216	194992	206	195086	213	195180	204
135868	61	135970	62	136072	64	138921	16	139416	207	139509	216	194994	206	195087	213	195181	204
135869	61	135971	62	136073	64	138922	12	139417	207	139510	216	194995	206	195088	213	195182	204
135870	61	135972	62	136074	64	138923	13	139418	207	139511	216	194996	206	195089	213	195183	205
135871	61	135973	62	136075	64	138924	13	139419	207	139512	203	194997	214	195090	213	195184	205
135872	61	135974	62	136076	64	138925	14	139420	207	139513	204	194998	214	195091	213	195185	205
135873	61	135975	62	136077	64	138926	17	139421	207	139514	204	194999	214	195092	213	195186	205
135874	61	135976	62	136078	64	138927	18	139422	207	139515	204	195000	214	195093	213	195187	205
135875	61	135977	62	136079	64	138928	18	139423	207	139516	205	195001	214	195094	213	195188	205
135876	61	135978	62	136080	64	138935	58	139424	207	139517	205	195002	214	195095	213	195189	205
135877	61	135979	62	136081	64	138936	58	139425	207	139518	205	195003	214	195096	213	195190	214
135878	61	135980	62	136082	64	138937	13	139426	207	139519	205	195004	214	195097	214	195191	214
135879	61	135981	62	136083	64	138938	13	139427	207	139520	205	195005	214	195098	216	195192	214
135880	61	135982	63	136084	64	138939	17	139428	208	139521	205	195006	215	195099	216	195193	214
135881	61	135983	63	136085	64	138940	17	139429	208	139522	205	195007	215	195100	216	195194	214
135882	61	135984	63	136086	64	138941	12	139430	208	139523	205	195008	215	195101	216	195195	214
135883	61	135985	63	136087	64	138944	13	139431	208	139524	205	195009	215	195102	216	195196	214
135884	61	135986	63	136088	64	138945	18	139432	208	139525	205	195010	215	195103	216	195197	212
135885	61	135987	63	136089	64	138946	189	139433	208	139526	205	195011	215	195104	216	195198	212
135886	61	135988	63	136090	64	138948	13	139434	208	139527	206	195012	207	195105	216	195199	213
135887	61	135989	63	136091	64	138951	17	139435	208	139528	206	195013	207	195106	216	195200	216
135888	61	135990	63	136092	64	138963	17	139436	208	139529	206	195014	207	195107	216	195201	204
135889	61	135991	63	136096	64	138964	17	139437	208	139530	206	195015	207	195108	203	195202	204
135890	61	135992	63	136097	64	138969	168	139438	208	139531	206	195016	207	195109	205	195203	204
135891	61	135993	63	136098	64	138970	157	139439	208	140883	236	195017	207	195110	205	195204	214
135892	61	135997	63	136099	64	138971	163	139440	209	140884	236	195018	207	195111	205	195205	214
135893	61	135998	63	136100	64	138972	162	139441	209	140885	236	195019	207	195112	205	195206	207
135894	61	135999	63	136101	64	138973	112	139442	209	140886	236	195020	207	195113	205	195207	207
135895	61	136000	63	136102	64	138974	92	139443	209	140887	236	195021	207	195114	206	195208	207
135896	61	136001	63	136103	64	138975	22	139444	209	140888	236	195022	207	195115	206	195209	207
135900	61	136002	63	136104	64	138976	23	139445	209	140889	236	195023	207	195116	206	195210	207
135901	61	136003	63	136105	64	138977	28	139446	209	140890	236	195024	208	195117	206	195211	207
135902	61	136004	63	136106	64	138978	115	139447	209	142182	238	195025	208	195118	206	195212	207
135903	61	136005	63	136107	64	138981	125	139448	209	142183	238	195026	208	195119	206	195213	207
135904	61	136006	63	136108	64	138984	124	139449	209	142184	238	195027	208	195120	206	195214	207
135905	61	136007	63	136109	64	138985	124	139450	209	142185	238	195028	208	195121	206	195215	207
135906	61	136008	63	136110	64	138986	126	139451	209	142186	238	195029	208	195122	206	195216	207
135907	61	136009	63	136111	64	138987	121	139452	210	142187	238	195030	208	195124	206	195217	207
135908	61	136010	63	136112	64	138989	171	139453	210	142188	238	195031	208	195125	206	195218	208
135909	61	136011	63	136113	64	138991	164	139454	210	142189	238	195032	208	195126	206	195219	208
135910	61	136012	63	138477													

Index by part number

Ref.	Page	Ref.	Page	Ref.	Page	Ref.	Page	Ref.	Page	Ref.	Page	Ref.	Page	Ref.	Page
195335	206	195429	212	195694	65	196008	106	196918	146	197275	39	197910	191	198063	151
195336	206	195430	212	195695	65	196009	106	196919	146	197276	39	197911	191	198064	151
195337	206	195431	212	195696	65	196010	106	196920	146	197277	39	197912	191	198065	151
195338	206	195432	213	195697	65	196011	106	196921	146	197278	39	197913	191	198066	151
195339	206	195433	213	195698	65	196012	106	196922	146	197348	8	197914	191	198067	151
195341	206	195434	213	195699	65	196013	106	196983	147	197585	145	197915	191	198068	151
195342	206	195435	213	195700	65	196014	106	196984	147	197586	146	197916	191	198069	151
195343	206	195436	213	195701	65	196015	106	196985	147	197587	147	197917	191	198070	151
195344	214	195437	213	195702	65	196016	106	196986	147	197824	37	197918	191	198071	151
195345	214	195438	213	195703	65	196309	234	196987	147	197825	37	197919	191	198072	151
195346	214	195439	213	195704	65	196310	234	196988	147	197826	37	197920	191	198073	151
195347	214	195440	213	195705	65	196311	234	196989	147	197827	37	197921	191	198074	151
195348	214	195441	213	195706	65	196314	234	196990	147	197828	37	197922	191	198075	151
195349	214	195442	213	195707	65	196320	234	196991	147	197829	37	197923	191	198076	151
195350	214	195443	213	195708	65	196777	145	196992	147	197830	37	197924	191	198077	151
195351	214	195444	214	195709	65	196778	145	196993	147	197831	37	197925	191	198078	151
195352	214	195445	216	195710	65	196779	145	196994	147	197832	37	197926	191	198079	151
195353	215	195446	216	195711	65	196780	145	196995	147	197833	37	197927	192	198080	151
195354	215	195447	216	195712	65	196781	145	196996	147	197834	37	197928	192	198081	151
195355	215	195448	216	195713	65	196782	145	196997	147	197835	37	197929	192	198082	151
195356	215	195449	216	195714	65	196783	145	196998	147	197836	37	197930	192	198083	151
195357	215	195450	216	195715	65	196784	145	196999	147	197837	37	197931	192	198084	151
195358	215	195451	216	195716	65	196785	145	197000	147	197838	37	197932	192	198085	151
195359	207	195452	216	195717	65	196786	145	197001	147	197839	37	197933	192	198086	151
195360	207	195453	216	195718	65	196787	145	197002	147	197840	37	197934	192	198087	151
195361	207	195454	216	195719	65	196788	145	197003	147	197841	37	197935	192	198088	151
195362	207	195455	203	195720	65	196789	145	197004	147	197842	37	197936	192	198089	151
195363	207	195456	203	195721	65	196790	145	197005	147	197843	37	197937	192	198090	151
195364	207	195457	203	195722	65	196791	145	197006	147	197844	37	197938	192	198091	151
195365	207	195458	203	195723	65	196792	145	197007	147	197845	37	197939	192	198092	151
195366	207	195459	203	195724	65	196793	145	197008	147	197846	37	197940	192	198093	151
195367	207	195460	203	195725	65	196794	145	197009	147	197847	37	197941	192	198094	151
195368	207	195461	203	195726	65	196795	145	197010	147	197848	60	197942	192	198095	151
195369	207	195462	203	195727	65	196796	145	197011	147	197849	60	197943	192	198096	151
195370	207	195463	203	195734	105	196797	145	197013	147	197850	60	197944	192	198157	148
195371	208	195464	203	195735	105	196798	145	197014	147	197851	60	197945	192	198158	148
195372	208	195465	203	195736	105	196799	145	197015	147	197852	60	197946	192	198159	148
195373	208	195466	203	195737	105	196800	145	197017	147	197853	60	197947	192	198160	148
195374	208	195467	204	195738	105	196803	145	197018	147	197854	60	197948	192	198161	148
195375	208	195468	204	195739	105	196804	145	197019	147	197855	60	197949	192	198162	148
195376	208	195469	204	195741	105	196805	145	197021	147	197856	60	197950	192	198163	148
195377	208	195470	204	195742	105	196806	145	197022	147	197857	60	197951	150	198164	148
195378	208	195471	204	195743	105	196807	145	197023	147	197858	60	197952	150	198165	148
195379	208	195472	204	195744	105	196808	145	197025	147	197859	60	197953	150	198166	148
195380	208	195473	204	195745	105	196809	145	197026	147	197860	60	197954	150	198167	148
195381	208	195474	204	195746	105	196810	145	197027	147	197861	60	197955	150	198168	148
195382	208	195475	204	195753	106	196811	145	197028	147	197862	60	197956	150	198169	148
195383	209	195476	204	195754	106	196812	145	197229	39	197863	60	197957	150	198170	148
195384	209	195477	204	195755	106	196813	145	197230	39	197864	60	197958	150	198171	148
195385	209	195478	204	195756	106	196814	145	197231	39	197865	60	197959	150	198172	148
195386	209	195479	205	195757	106	196815	145	197232	39	197866	60	197960	150	198173	148
195387	209	195480	205	195758	106	196816	145	197233	39	197867	60	197961	150	198174	148
195388	209	195481	205	195760	106	196817	145	197234	39	197868	60	197962	150	198175	148
195389	209	195482	205	195761	106	196818	145	197235	39	197869	60	197963	150	198176	148
195390	209	195483	205	195762	106	196819	145	197236	39	197870	60	197964	150	198177	148
195391	209	195484	205	195763	106	196820	145	197237	39	197871	60	197965	150	198178	148
195392	209	195485	205	195764	106	196881	146	197238	39	197872	60	197966	150	198179	148
195393	209	195486	205	195765	106	196882	146	197239	39	197873	60	197967	150	198180	148
195394	209	195487	205	195837	232	196883	146	197240	39	197874	60	197968	150	198181	148
195395	210	195488	205	195838	232	196884	146	197241	39	197875	60	197969	150	198182	148
195396	210	195489	205	195839	232	196885	146	197242	39	197876	60	197970	150	198183	148
195397	210	195490	205	195840	232	196886	146	197243	39	197877	60	197971	150	198184	148
195398	210	195491	206	195841	232	196887	146	197244	39	197879	191	197972	150	198185	148
195399	210	195492	206	195842	232	196888	146	197245	39	197880	191	197973	150	198186	148
195400	210	195493	206	195843	232	196889	146	197246	39	197881	191	197974	150	198187	148
195401	210	195494	206	195844	232	196890	146	197247	39	197882	191	197975	150	198188	148
195402	210	195495	206	195902	198	196891	146	197248	39	197883	191	197976	150	198189	148
195403	210	195496	206	195903	198	196892	146	197249	39	197884	191	197977	150	198190	148
195404	210	195497	206	195904	198	196893	146	197250	39	197885	191	197978	150	198191	148
195405	210	195498	206	195905	198	196894	146	197251	39	197886	191	197979	150	198192	148
195406	210	195499	206	195906	198	196895	146	197252	39	197887	191	197980	150	198193	148
195407	211	195501	206	195907	198	196896	146	197253	39	197888	191	197981	150	198194	148
195408	211	195502	206	195908	198	196897	146	197254	39	197889	191	197982	150	198195	148
195409	211	195503	206	195909	198	196898	146	197255	39	197890	191	197983	150	198196	148
195410	211	195504	214	195913	198	196899	146	197256	39	197891	191	197984	150	198197	148
195411	211	195505	214	195914	198	196900	146	197257	39	197892	191	197985	150	198198	148
195412	211	195506	214	195915	198	196901	146	197258	39	197893	191	197986	150	198199	148
195413	211	195507	214	195922	152	196902	146	197259	39	197894	191	197987	150	198200	149
195414	211	195508	214	195923	152</										

Index by part number

Ref.	Page	Ref.	Page	Ref.	Page	Ref.	Page	Ref.	Page	Ref.	Page	Ref.	Page	Ref.	Page	Ref.	Page		
223604	223	244728	83	250455	50	252301	193	258950	223	702232	67	806666	228	811721	221	814276	11	814509	15
223605	223	244729	83	250456	50	252307	226	258952	223	702233	67	806667	228	811722	221	814277	11	814510	15
223606	223	244730	83	250457	50	252308	226	258953	223	702234	67	806668	228	812939	234	814278	11	814511	15
223607	223	244731	83	250458	50	252446	50	258955	223	702235	67	806669	228	813599	224	814278	5	814512	15
223648	193	244732	83	250459	50	252447	50	258956	223	702236	67	806670	228	813600	224	814279	11	814513	15
223653	152	244733	83	250460	51	252448	50	258961	224	702262	68	806671	228	813601	224	814284	11	814514	15
223657	153	244734	83	250461	51	252449	50	258962	224	702263	68	806672	228	813602	224	814284	5	814515	15
223658	153	244735	83	250462	51	252451	50	258967	224	702264	68	806673	228	813603	224	814285	11	814516	15
223696	227	244736	83	250463	51	252452	51	258968	224	710599	239	806674	228	813604	224	814286	11	814517	15
223697	227	244737	83	250464	51	252453	51	258970	224	710600	239	806675	228	813992	229	814287	11	814518	15
223698	227	244738	83	250474	51	252454	51	258971	224	710601	239	806676	228	813993	229	814336	11	814519	15
223699	227	244739	83	250551	226	252455	51	258976	224	710603	239	806677	228	813994	229	814337	11	814520	15
223704	227	244740	83	250552	226	252456	51	258977	224	710604	239	806678	228	814013	221	814338	11	814521	15
223705	227	244741	83	250553	226	252457	51	258979	224	710731	239	806870	194	814014	221	814339	11	814522	15
227309	108	244742	83	250554	226	252551	226	258980	224	710737	239	806871	194	814015	221	814340	11	814523	15
227314	108	244743	83	250555	226	252552	226	263387	69	710738	239	806872	194	814016	221	814341	11	814524	15
227334	108	244752	83	250556	226	252553	226	286688	153	710739	239	806873	194	814017	221	814342	11	814525	15
227339	108	244753	83	250558	226	252554	226	286814	153	710740	239	806874	194	814018	221	814343	11	814526	15
227362	108	244754	83	250559	226	252555	226	622080	232	711190	236	806875	194	814019	221	814344	11	814593	22
227367	108	244755	83	250560	226	252556	226	622085	232	711191	236	806876	194	814020	221	814345	11	814594	22
227587	223	244756	83	250561	226	252558	226	622086	232	711192	236	806877	194	814021	221	814346	11	814595	22
227588	223	244757	83	250562	226	252559	226	622087	232	711193	236	806878	194	814022	221	814347	11	814596	22
227589	223	244758	83	250564	227	252560	226	622092	232	711194	236	810881	108	814023	221	814348	11	814597	22
227590	223	244759	83	250566	227	252561	226	622095	232	802043	108	810882	108	814024	221	814349	11	814598	22
227591	223	244760	83	250567	227	252563	227	622096	232	802044	108	810883	108	814025	221	814350	11	814600	22
227592	223	244761	83	250568	229	252565	227	622097	232	802045	108	810884	108	814026	221	814351	11	814601	22
227593	223	244762	83	250569	229	252566	227	622098	232	803996	108	810885	108	814027	221	814352	11	814602	22
227594	223	244763	83	250570	229	254161	192	622099	232	803997	229	810886	108	814028	221	814353	11	814604	22
227595	223	244772	83	250630	109	254162	192	622100	232	805532	228	810887	108	814029	221	814354	11	814605	22
227596	223	244773	83	250632	109	254164	194	622307	222	805533	228	810888	108	814030	221	814355	11	814606	22
227597	223	244774	83	250633	109	254167	193	622308	222	805534	228	810889	108	814031	221	814356	11	814608	22
227598	223	244775	83	250634	109	254168	193	622309	222	805535	228	810890	108	814032	221	814357	11	814609	22
227599	233	244776	83	251264	193	255016	152	622310	222	805790	228	810917	195	814033	221	814380	19	814610	22
227626	50	244777	83	251265	193	255017	152	622311	222	805791	228	810918	195	814034	221	814381	19	814611	22
227628	50	244778	83	251290	226	255024	153	622312	222	805792	228	810919	195	814035	221	814382	19	814612	22
227630	50	244779	83	251291	226	255025	153	622313	222	805793	228	810920	195	814036	221	814383	19	814613	22
227631	50	244800	83	251641	224	255026	153	622314	222	805794	228	810921	195	814037	221	814384	19	814614	22
227632	50	244801	83	251642	230	255027	153	622315	222	805795	228	810922	195	814038	221	814385	19	814615	22
227633	50	244802	83	251643	230	255136	193	622316	222	805809	228	810923	195	814039	221	814387	19	814616	22
227634	50	244803	83	251644	230	255137	193	622317	222	805810	228	810934	224	814040	221	814388	19	814617	22
227635	50	244820	83	251645	230	255240	108	622318	222	805811	228	810935	224	814156	155	814389	19	814618	22
227636	50	244821	83	251920	69	255241	108	622319	222	805870	228	810936	224	814157	155	814390	19	814619	22
227638	51	244822	83	251925	69	256456	233	622320	222	806615	228	810937	224	814158	155	814391	19	814664	22
227640	51	244824	83	251926	69	257502	223	622321	222	806616	228	810938	224	814159	155	814392	19	814665	22
227642	51	244825	83	251928	69	257503	223	622322	222	806617	228	810939	224	814160	155	814393	19	814666	22
227643	51	244826	83	251930	69	257504	223	622323	222	806618	228	810940	224	814161	155	814395	19	814667	22
227644	51	244827	83	251932	69	257505	223	622324	222	806619	228	810941	224	814162	155	814396	19	814668	22
227645	51	244828	83	251953	109	257506	223	622325	222	806620	228	810942	224	814163	155	814397	19	814669	22
227646	51	244831	83	251954	109	257507	223	622326	222	806621	228	810944	224	814164	155	814398	19	814670	22
227647	51	244832	83	251960	152	257508	223	622327	222	806622	228	810945	224	814166	155	814407	20	814671	22
227648	51	244833	83	251965	229	257509	223	622328	222	806623	228	811678	221	814167	155	814408	20	814672	22
227791	223	244834	83	251969	83	257510	223	622329	222	806624	228	811679	221	814168	155	814409	20	814673	22
227792	223	244835	83	251970	83	257511	223	622330	222	806625	228	811680	221	814169	155	814410	20	814674	22
227793	223	244837	83	251971	83	257514	224	622331	222	806626	228	811681	221	814170	155	814411	20	814675	22
227794	223	244838	83	251972	83	257515	224	622332	222	806627	228	811682	221	814171	155	814412	20	814676	22
227795	223	244839	83	251973	83	257518	224	622333	222	806628	228	811683	221	814172	155	814414	20	814677	22
227796	223	244840	83	251974	83	257519	224	622334	222	806629	228	811684	221	814217	155	814416	20	814678	22
241163	194	244841	83	251975	83	257524	224	622335	222	806630	228	811685	221	814218	155	814417	20	814679	22
241529	153	244842	83	251976	83	257525	224	622336	222	806631	228	811686	221	814219	155	814418	20	814680	22
241530	153	244843	83	251977	83	257526	224	622337	222	806632	228	811687	221	814220	155	814419	20	814681	22
241531	153	244849	83	251978	83	257527	224	622338	222	806633	228	811688	221	814221	155	814420	20	814682	22
241532	153	244850	83	251979	83	257528	224	622339	222	806634	228	811689	221	814222	155	814422	20	814683	22
241533	153	244851	83	251980	83	257529	229	622340	222	806635	228	811690	221	814223	155	814423	20	814684	22
241534	153	244852	83	251981	83	257530	230	622341	222	806636	228	811691	221	8					

Ref.	Page	Ref.	Page	Ref.	Page	Ref.	Page	Ref.	Page	Ref.	Page	Ref.	Page	Ref.	Page	Ref.	Page
825791	138	826178	141	826541	142	826986	74	827409	77	827722	79	828101	82	828460	85	828840	88
825792	138	826223	141	826542	142	827053	75	827410	77	827723	79	828102	82	828461	85	828841	88
825793	138	826224	141	826609	71	827054	75	827411	77	827724	79	828103	82	828462	85	828842	88
825794	138	826225	141	826610	71	827055	75	827412	77	827725	79	828104	82	828463	85	828843	88
825795	138	826226	141	826611	71	827056	75	827413	77	827726	79	828149	82	828464	85	828844	88
825796	138	826227	141	826612	71	827057	75	827414	77	827793	80	828150	82	828465	85	828889	88
825797	138	826228	141	826613	71	827058	75	827415	77	827794	80	828151	82	828466	85	828890	88
825864	139	826229	141	826614	71	827059	75	827416	77	827795	80	828152	82	828533	86	828891	88
825865	139	826230	141	826615	71	827060	75	827417	77	827796	80	828153	82	828534	86	828892	88
825866	139	826231	141	826616	71	827061	75	827418	77	827797	80	828154	82	828535	86	828893	88
825867	139	826232	141	826617	71	827062	75	827419	77	827798	80	828155	82	828536	86	828894	88
825868	139	826233	141	826618	71	827063	75	827420	77	827799	80	828156	82	828537	86	828895	88
825869	139	826234	141	826619	71	827064	75	827421	77	827800	80	828157	82	828538	86	828896	88
825870	139	826235	141	826620	71	827065	75	827422	77	827801	80	828158	82	828539	86	828897	88
825871	139	826236	141	826621	71	827066	75	827423	77	827802	80	828159	82	828540	86	828898	88
825872	139	826237	141	826622	71	827067	75	827424	77	827803	80	828160	82	828541	86	828899	88
825874	139	826238	141	826623	71	827068	75	827425	77	827804	80	828161	82	828542	86	828900	88
825875	139	826239	141	826624	71	827113	75	827426	77	827805	80	828162	82	828543	86	828901	88
825876	139	826240	141	826657	73	827114	75	827427	77	827806	80	828163	82	828544	86	828902	88
825878	139	826241	141	826758	73	827115	75	827428	77	827807	80	828164	82	828545	86	828903	88
825879	139	826242	141	826759	73	827116	75	827429	77	827808	80	828165	82	828546	86	828904	88
825880	139	826243	141	826760	73	827117	75	827430	77	827853	80	828166	82	828547	86	828905	88
825925	139	826244	141	826761	73	827118	75	827497	78	827854	80	828167	82	828548	86	828906	88
825926	139	826312	141	826762	73	827119	75	827498	78	827855	80	828168	82	828549	86	828907	88
825927	139	826314	141	826763	73	827120	75	827499	78	827856	80	828169	82	828594	86	828908	88
825928	139	826315	141	826764	73	827121	75	827500	78	827857	80	828170	82	828595	86	828909	88
825929	139	826316	141	826765	73	827122	75	827501	78	827858	80	828238	84	828596	86	828910	88
825930	139	826317	141	826766	73	827123	75	827502	78	827859	80	828239	84	828597	86	828977	89
825931	139	826318	141	826767	73	827124	75	827503	78	827860	80	828240	84	828598	86	828978	89
825932	139	826319	141	826768	73	827125	75	827504	78	827861	80	828241	84	828599	86	828979	89
825933	139	826321	141	826769	73	827126	75	827505	78	827862	80	828242	84	828600	86	828980	89
825934	139	826322	141	826770	73	827127	75	827506	78	827863	80	828243	84	828601	86	828981	89
825935	139	826323	141	826771	73	827128	75	827507	78	827864	80	828244	84	828602	86	828982	89
825936	139	826325	141	826772	73	827129	75	827508	78	827865	80	828245	84	828603	86	828983	89
825937	139	826326	141	826817	73	827130	75	827509	78	827866	80	828247	84	828604	86	828984	89
825938	139	826327	141	826818	73	827131	75	827510	78	827867	80	828248	84	828605	86	828985	89
825939	139	826372	141	826819	73	827132	75	827511	78	827868	80	828249	84	828606	86	828986	89
825940	139	826373	141	826820	73	827133	75	827512	78	827869	80	828250	84	828607	86	828987	89
825941	139	826374	141	826821	73	827134	75	827557	78	827870	80	828251	84	828608	86	828988	89
825942	139	826375	141	826822	73	827201	76	827558	78	827871	80	828252	84	828609	86	828989	89
825943	139	826376	141	826823	73	827202	76	827559	78	827872	80	828297	84	828610	86	828990	89
825944	139	826377	141	826824	73	827203	76	827560	78	827873	80	828298	84	828611	86	828991	89
825945	139	826378	141	826825	73	827204	76	827561	78	827874	80	828299	84	828612	86	828992	89
825946	139	826379	141	826826	73	827205	76	827562	78	827941	81	828300	84	828613	86	829037	89
826013	140	826380	141	826827	73	827206	76	827563	78	827942	81	828301	84	828614	86	829038	89
826014	140	826381	141	826828	73	827207	76	827564	78	827943	81	828302	84	828681	87	829039	89
826015	140	826382	141	826829	73	827208	76	827565	78	827944	81	828303	84	828682	87	829040	89
826016	140	826383	141	826830	73	827209	76	827566	78	827945	81	828304	84	828683	87	829041	89
826017	140	826384	141	826831	73	827210	76	827567	78	827946	81	828305	84	828684	87	829042	89
826018	140	826385	141	826832	73	827211	76	827568	78	827947	81	828306	84	828685	87	829043	89
826019	140	826386	141	826833	73	827212	76	827569	78	827948	81	828307	84	828686	87	829044	89
826020	140	826387	141	826834	73	827213	76	827570	78	827949	81	828308	84	828687	87	829045	89
826021	140	826388	141	826835	73	827214	76	827571	78	827950	81	828309	84	828688	87	829046	89
826023	140	826389	141	826836	73	827215	76	827572	78	827951	81	828310	84	828689	87	829047	89
826024	140	826390	141	826837	73	827216	76	827573	78	827952	81	828311	84	828690	87	829048	89
826025	140	826391	141	826838	73	827261	76	827574	78	827953	81	828312	84	828691	87	829049	89
826027	140	826392	141	826905	74	827262	76	827575	78	827954	81	828313	84	828692	87	829050	89
826028	140	826393	141	826906	74	827263	76	827576	78	827955	81	828314	84	828693	87	829051	89
826029	140	826460	142	826907	74	827264	76	827577	78	827956	81	828315	84	828694	87	829052	89
826074	140	826461	142	826908	74	827265	76	827578	78	828001	81	828316	84	828695	87	829053	89
826075	140	826462	142	826909	74	827266	76	827645	79	828002	81	828317	84	828696	87	829054	89
826076	140	826463	142	826910	74	827267	76	827646	79	828003	81	828318	84	828741	87	829055	89
826077	140	826464	142	826911	74	827268	76	827647	79	828004	81	828385	85	828742	87	829056	89
826078	140	826465	142	826912	74	827269	76	827648	79	828005	81	828386	85	828743	87	829057	89
826079	140	826466	142	826913	74	827270	76	827649	79	828006	81	828387	85	828744	87	829058	89
826080	140	826467	142	826914	74	827271	76	827650	79	828007	81	828388	85	828745	87	829125	90
826081	140	826468	142	826915	74	827272	76	827651	79	828008	81	828389	85	828746	87	829126	90
826082	140	826470	142	826916	74	827273	76	827652	79	828009	81	828390	85	828747	87	829127	90
826083	140	826471	142	826917	74	827274	76	827653	79	828010	81	828391	85	828748	87	829128	90
826084	140	826472	142	826918	74	827275	76	827654	79	828011	81	828392	85	828749	87	829129	90
826085	140	826474	142	826919	74	827276	76	827655	79	828012	81	828393	85	828750	87	829130	90
826086	140	826475	142	826920	74	827277	76	827656	79	828013	81	828394	85	828751	87	829131	90
82																	

Index by part number

Ref.	Page	Ref.	Page	Ref.	Page	Ref.	Page	Ref.	Page	Ref.	Page	Ref.	Page	Ref.	Page
829576	93	829933	95	830312	98	830669	100	831026	182	831119	101	831242	38	831350	143
829577	93	829934	95	830313	98	830670	100	831027	182	831120	101	831243	38	831351	143
829578	93	829935	95	830314	98	830671	100	831028	182	831121	101	831244	38	831352	143
829579	93	829936	95	830315	98	830672	100	831029	182	831122	101	831245	38	831353	143
829580	93	829937	95	830316	98	830673	100	831030	182	831123	101	831246	38	831354	143
829581	93	829938	95	830317	98	830674	100	831031	182	831124	101	831247	38	831355	143
829582	93	829939	95	830318	98	830675	100	831032	182	831125	101	831249	38	831356	143
829583	93	829940	95	830319	98	830676	100	831033	182	831126	101	831250	38	831357	143
829584	93	829941	95	830320	98	830677	100	831034	182	831127	101	831251	38	831358	143
829629	93	829942	95	830321	98	830678	100	831035	182	831128	101	831252	38	831359	143
829630	93	829943	95	830322	98	830679	100	831036	182	831129	101	831261	32	831360	143
829631	93	829944	95	830323	98	830680	100	831037	182	831130	101	831262	32	831361	143
829632	93	829945	95	830324	98	830681	100	831038	182	831131	101	831263	32	831363	143
829633	93	829946	95	830369	98	830682	100	831039	182	831132	102	831264	32	831364	143
829634	93	830013	96	830370	98	830683	100	831040	182	831133	102	831265	32	831365	143
829635	93	830014	96	830371	98	830684	100	831041	182	831134	102	831266	32	831366	105
829636	93	830015	96	830372	98	830685	100	831042	182	831135	102	831268	32	831367	105
829637	93	830016	96	830373	98	830686	100	831043	182	831136	102	831269	32	831368	105
829638	93	830017	96	830374	98	830792	66	831044	182	831137	102	831270	32	831369	105
829639	93	830018	96	830375	98	830793	66	831045	182	831138	102	831271	32	831370	105
829640	93	830019	96	830376	98	830794	66	831046	182	831139	102	831272	32	831371	105
829641	93	830020	96	830377	98	830795	66	831047	182	831140	102	831273	32	831372	105
829642	93	830021	96	830378	98	830796	66	831048	182	831142	102	831274	32	831373	105
829643	93	830022	96	830379	98	830797	66	831049	183	831143	102	831276	32	831374	105
829644	93	830023	96	830380	98	830799	66	831050	183	831144	102	831277	32	831375	105
829645	93	830024	96	830381	98	830800	66	831051	183	831145	102	831278	32	831376	105
829646	93	830025	96	830382	98	830801	66	831052	183	831146	102	831279	32	831377	105
829647	93	830026	96	830383	98	830802	66	831053	183	831147	102	831280	32	831378	105
829648	93	830027	96	830384	98	830803	66	831054	183	831148	103	831281	32	831379	105
829649	93	830028	96	830385	98	830804	66	831055	183	831149	103	831282	32	831380	105
829650	93	830073	96	830386	98	830805	66	831056	183	831150	103	831283	32	831381	105
829717	94	830074	96	830387	98	830807	66	831057	183	831151	103	831284	32	831382	102
829718	94	830075	96	830388	98	830808	66	831058	183	831152	103	831285	32	831383	102
829719	94	830076	96	830389	98	830809	66	831059	183	831153	103	831286	32	831384	102
829720	94	830077	96	830390	98	830810	66	831060	183	831154	103	831287	32	831385	102
829721	94	830078	96	830457	99	830811	66	831061	183	831155	103	831288	37	831386	102
829722	94	830079	96	830458	99	830812	66	831062	183	831156	103	831289	37	831387	102
829723	94	830080	96	830459	99	830813	66	831063	183	831158	103	831290	37	831388	102
829724	94	830081	96	830460	99	830814	66	831064	183	831159	103	831291	37	831389	102
829725	94	830082	96	830461	99	830819	66	831065	183	831160	103	831292	37	831390	102
829726	94	830083	96	830462	99	830820	66	831066	183	831161	103	831293	37	831391	102
829727	94	830084	96	830463	99	830821	66	831067	183	831162	103	831295	37	831392	102
829728	94	830085	96	830464	99	830822	66	831068	183	831163	103	831296	37	831393	102
829729	94	830086	96	830465	99	830823	66	831069	183	831164	103	831297	37	831394	102
829730	94	830087	96	830466	99	830824	66	831070	183	831165	103	831298	37	831395	102
829731	94	830088	96	830467	99	830826	66	831071	183	831166	103	831299	37	831396	102
829732	94	830089	96	830468	99	830827	66	831072	183	831167	103	831300	37	831397	102
829733	94	830090	96	830469	99	830828	66	831073	183	831168	103	831301	37	831398	104
829734	94	830091	96	830470	99	830829	66	831074	183	831169	103	831303	37	831399	104
829735	94	830092	96	830471	99	830830	66	831075	183	831170	103	831304	37	831400	104
829736	94	830093	96	830472	99	830831	66	831076	183	831171	103	831305	37	831401	104
829737	94	830094	96	830517	99	830832	66	831077	183	831172	103	831306	37	831402	104
829738	94	830161	97	830518	99	830834	66	831078	183	831173	103	831307	37	831403	104
829739	94	830162	97	830519	99	830835	66	831079	183	831174	103	831308	37	831404	104
829740	94	830163	97	830520	99	830836	66	831080	183	831175	103	831309	37	831405	104
829741	94	830164	97	830521	99	830837	66	831081	183	831176	103	831310	37	831406	104
829742	94	830165	97	830522	99	830838	66	831082	183	831177	103	831311	37	831408	104
829743	94	830166	97	830523	99	830839	66	831083	125	831178	103	831312	37	831409	104
829744	94	830167	97	830524	99	830840	66	831084	125	831179	103	831313	37	831410	104
829745	94	830168	97	830525	99	830841	66	831085	125	831180	31	831314	37	831411	104
829746	94	830169	97	830526	99	830890	3	831086	125	831181	31	831315	181	831412	104
829747	94	830170	97	830527	99	830890	5	831087	125	831182	31	831316	181	831413	104
829748	94	830171	97	830528	99	830928	13	831088	125	831183	31	831317	181	831480	221
829749	94	830172	97	830529	99	830943	13	831089	125	831184	31	831318	181	831481	221
829750	94	830173	97	830530	99	830944	13	831090	125	831190	31	831319	181	831482	221
829751	94	830174	97	830531	99	830945	13	831091	125	831191	31	831320	181	831483	221
829752	94	830175	97	830532	99	830950	13	831092	125	831192	31	831321	181	831484	221
829753	94	830176	97	830533	99	830998	181	831093	125	831197	31	831322	181	831485	221
829754	94	830221	97	830534	99	830999	181	831094	125	831198	31	831323	181	831486	221
829755	94	830222	97	830535	99	831000	181	831095	125	831207	38	831324	181	831487	221
829756	94	830223	97	830536	99	831001	181	831096	125	831208	38	831325	181	831488	221
829757	94	830224	97	830537	99	831002	181	831097	125	831209	38	831326	181	831495	13
829758	94	830225	97	830538	99	831003	181	831098	125	831210	38	831327	181	831495	5
829759	94	830226	97	830605	100	831004	181	831099	125	831211	38	831328	181	831496	13
829760	94	830227	97	830606	100	831005	181	831100	101	831212	38	831329	181	831497	13
829761	94	830228	97	830607	100	831006	181	831101	101	831213	38	831330	181	831498	13
829762	94	830229	97	830608	100	831007	181	831102	101	831215	38	831331	181	831499	13
829763	94	830230	97	830609	100	831008	181	831103	101	831216	38	831333	143	831499	13
829764	94	830231	97	830610	100	831009	181	831104	101	831217	38	831334	143	831499	13
829765	94	830232	97	830611	100	831010	181	831105	101	831218	38	831335	143	831499	1

Index by part number

Ref.	Page	Ref.	Page	Ref.	Page	Ref.	Page	Ref.	Page	Ref.	Page	Ref.	Page	Ref.	Page	Ref.	Page
834683	38	834900	17	835581	155	835758	173	835945	121	836095	140	836207	90	836362	12	836554	28
834687	38	834901	17	835582	156	835759	174	835946	121	836096	140	836208	91	836363	12	836555	28
834688	38	834902	17	835590	156	835760	174	835952	121	836097	140	836209	91	836364	12	836556	28
834689	38	834903	17	835593	156	835761	174	835968	122	836098	140	836210	91	836365	5	836557	28
834690	38	834904	17	835595	156	835763	174	835969	122	836099	140	836211	91	836366	12	836558	28
834692	38	834905	17	835600	156	835764	174	835977	122	836115	143	836212	91	836367	21	836559	28
834693	38	834906	17	835601	157	835765	175	835979	122	836116	143	836213	92	836368	21	836560	28
834694	38	834907	17	835609	157	835766	175	835980	122	836117	143	836214	92	836369	21	836565	29
834695	38	834908	17	835611	157	835767	175	835981	123	836118	143	836215	92	836370	21	836566	29
834696	38	834941	50	835615	157	835768	175	835982	123	836119	143	836216	92	836372	12	836567	29
834697	38	834942	50	835618	158	835769	175	835984	123	836120	143	836217	92	836375	12	836568	29
834698	38	834943	50	835620	158	835770	176	835985	123	836121	143	836218	93	836376	12	836569	29
834701	38	834944	50	835624	159	835771	176	835986	123	836122	143	836219	93	836382	13	836570	29
834702	38	834946	50	835626	159	835772	176	835987	124	836123	143	836220	93	836383	13	836572	30
834703	38	834948	50	835633	159	835775	176	835988	124	836124	143	836221	93	836384	13	836575	30
834704	38	834949	50	835634	159	835776	176	835992	124	836125	152	836222	93	836386	13	836576	30
834705	38	834951	50	835635	159	835777	177	835994	124	836126	152	836223	94	836388	13	836577	30
834706	16	834952	50	835636	160	835782	177	835995	124	836127	152	836224	94	836389	13	836579	30
834707	16	834953	50	835637	160	835783	177	835996	125	836128	152	836225	94	836390	13	836580	34
834709	16	834955	50	835638	160	835786	177	835997	125	836130	72	836226	94	836391	13	836581	34
834711	16	834957	50	835641	160	835787	177	835998	125	836131	72	836227	94	836393	13	836582	34
834713	18	834958	50	835642	160	835796	178	835999	125	836132	72	836228	95	836394	13	836583	34
834714	18	834960	50	835646	161	835804	178	836011	125	836133	72	836229	95	836395	13	836584	34
834718	18	834961	50	835647	161	835822	178	836013	126	836134	72	836230	95	836396	13	836585	34
834719	18	834962	50	835648	161	835824	178	836016	126	836135	74	836231	95	836397	13	836586	34
834720	18	834975	51	835649	161	835825	178	836022	126	836136	74	836232	95	836399	13	836587	34
834721	18	834976	51	835650	161	835826	179	836023	126	836137	74	836233	96	836400	13	836589	34
834722	18	834977	51	835653	162	835829	179	836024	126	836138	74	836234	96	836401	13	836590	34
834723	17	834978	51	835654	162	835831	179	836025	127	836139	74	836235	96	836412	21	836591	34
834724	17	834979	51	835655	162	835832	179	836026	127	836140	75	836236	96	836413	21	836592	34
834725	17	834980	51	835656	162	835843	179	836027	127	836141	75	836237	96	836414	21	836593	34
834726	17	834981	51	835657	162	835844	180	836028	127	836142	75	836238	97	836421	14	836594	34
834731	17	834982	51	835658	163	835845	180	836029	127	836143	75	836239	97	836422	14	836595	34
834732	17	834983	51	835659	163	835846	180	836030	128	836144	75	836240	97	836423	14	836596	34
834735	17	834984	51	835660	163	835847	180	836031	128	836145	76	836241	97	836428	14	836597	34
834736	17	834985	51	835661	163	835848	180	836032	128	836146	76	836242	97	836431	19	836598	34
834737	15	834987	51	835662	163	835849	181	836033	128	836147	76	836243	98	836432	19	836599	34
834738	15	834991	51	835663	163	835856	181	836034	128	836148	76	836244	98	836433	19	836600	34
834739	15	834992	51	835664	163	835861	181	836035	129	836149	76	836245	98	836434	19	836601	34
834740	15	834993	51	835665	164	835862	181	836036	129	836150	77	836246	98	836435	19	836602	34
834741	18	834994	51	835666	164	835863	181	836037	129	836151	77	836247	98	836436	19	836603	34
834742	18	834995	51	835667	164	835864	181	836038	129	836152	77	836249	99	836437	19	836604	34
834744	15	834996	51	835668	164	835865	181	836039	129	836153	77	836250	99	836442	20	836605	34
834745	15	834998	51	835669	164	835866	181	836041	130	836154	77	836251	99	836443	20	836606	34
834747	15	834999	51	835670	164	835867	181	836042	130	836155	78	836252	99	836444	11	836607	34
834748	15	835005	66	835671	164	835868	181	836043	130	836156	78	836253	99	836445	11	836608	34
834753	15	835006	66	835672	165	835869	182	836044	130	836157	78	836254	100	836446	11	836609	34
834754	15	835007	66	835673	165	835870	182	836045	130	836158	78	836255	100	836447	11	836610	34
834755	15	835008	66	835674	165	835871	182	836048	131	836159	78	836256	100	836448	11	836611	34
834756	15	835129	53	835675	165	835872	182	836049	131	836160	79	836257	100	836449	16	836612	34
834757	15	835130	53	835678	165	835873	182	836050	131	836161	79	836258	100	836450	16	836613	34
834758	15	835135	53	835679	166	835874	182	836051	131	836162	79	836259	101	836451	16	836614	34
834759	15	835136	53	835680	166	835875	182	836053	131	836163	79	836260	101	836452	16	836615	34
834760	15	835149	53	835681	166	835876	182	836054	132	836164	79	836261	101	836453	16	836616	34
834762	15	835156	53	835682	166	835877	182	836055	132	836165	80	836262	101	836454	16	836617	34
834763	15	835157	53	835683	166	835878	182	836056	132	836166	80	836263	101	836455	18	836618	34
834764	16	835159	53	835684	167	835879	183	836057	132	836167	80	836264	101	836456	18	836619	34
834765	16	835161	53	835685	167	835880	183	836058	132	836168	80	836265	101	836457	18	836620	34
834767	16	835183	54	835686	167	835881	183	836060	133	836169	80	836266	101	836458	18	836621	34
834768	16	835185	54	835687	167	835882	183	836061	133	836170	81	836267	101	836459	18	836622	34
834769	16	835198	54	835688	167	835888	183	836062	133	836171	81	836268	101	836460	18	836623	34
834771	16	835203	54	835689	168	835889	183	836063	133	836172	81	836269	102	836461	17	836624	34
834772	16	835210	55	835690	168	835890	183	836064	133	836173	81	836270	102	836464	17	836625	34
834773	16	835212	55	835691	169	835892	183	836065	134	836174	81	836271	102	836465	17	836626	34
834775	16	835213	55	835692	169	835893	183	836066	134	836176	84	836272	102	836467	17	836627	34
834776	16	835214	55	835693	169	835894	183	836067	134	836177	84	836273	102	836468	17	836628	34
834777	18	835233	56	835694	169	835905	114	836068	134	836178	84	836274	102	836469	17	836629	34
834779	18	835235	56	835695	169	835906	114	836069	134	836179	84	836275	102	836475	16	836630	34
834780	18	835237	56	835696	169	835908	114	836070	135	836180	84	836276	102	836483	18	836631	34
834781	18	835241	56	835698	169	835909	114	836071	135	836181	85	836277	102	836490	18	836632	34
834782	18	835254	56	835699	170	835912	114	836072	135	836182	85	836278	102	836498	17	836633	34
834783	18	835257	56	835703	170	835921											

Index by description

Description	Page
45° direction arrow - IMO322	204
45° direction arrow - IMO407	214
90° direction arrow - IMO321	204
90° direction arrow - IMO406	214
ADR LQ	229
ADR LQ Y	229
ADR QE	229
Alighting from toboggan to the left - M050	191
Alighting from toboggan to the right - M051	191
Area protected with halon 1301 - IMO111	207
Assembly point on board the vessel - IMO320	204
Attach safety belt - IMO201	216
Authorisation of... - IMO342	206
Automated external heart defibrillator - E010	27
Automatic extinguisher - IMO145	210
B-2595/B-2569 Inkjet Receptive Polyester and Vinyl Labels	237
B-595 Pre-cut and pre-printed blank labels with header	239
B-595 Pre-printed pre-cut blank sign headers	236
BBP30 and BBP31 Sign and Label Printer	239
BBP™85 Sign and Label Printer	236
Bilge pump - IMO121	208
Blank Glow-in-the-dark sign	234
Block valves of the deluge system - IMO129	209
BMP35 Multicolour Sign & Label Printer	238
BMP37 Multicolour & Cut Sign & Label Printer	238
BMP71 Label Printer	239
Boarding ladder - IMO323	204
Bottles of CO2 - IMO148	210
Bottles of halon 1301 - IMO110	207
Bottles of halon 1301 stored in a protected area - IMO150	211
Brady Workstation	238
BradyJet J5000 Colour Label Printer	237
Break to obtain access - E008	25
Breathing apparatus - IMO168	216
CabinetContaining firefighting suit - IMO167	212
CabinetContaining protectiveClothing - IMO169	212
Cafeteria - PIC 460	226
Catering area - IMO353	206
CE logo - Pic 467	229
Check guard - M027	181
Child seat presence and orientation detection system (CPOD) - E014	31
Child's lifejacket - E045	45
Class A automatic fire door - IMO133	209
Class A automatic fire door - IMO135	209

Description	Page
Class A fire door - IMO132	209
Class A fire door - IMO134	209
Class A partition - IMO131	209
Class B automatic fire door - IMO139	210
Class B automatic fire door - IMO141	210
Class B fire door - IMO138	210
Class B fire door - IMO140	210
Class B partition - IMO137	210
Close and attach traps in the launching order - IMO202	216
Close and secure hatches in launch sequence - M037	186
Close safety bar of chairlift - M033	184
CLP/GHS Pictograms	218
CO2 horn - IMO108	207
CO2 trigger station - IMO109	207
CO2/2 portable extinguisher - IMO182	213
CO2/30 wheel-mounted fire extinguisher CO2/30 - IMO186	214
Cold-environment double-sided adhesive tape	234
Collection of fire-fighting equipment - F004	56
Colour cable ties	234
Connect an earth terminal to the ground - M005	159
Control station - IMO166	212
Corrosive substances - ADR 8 - Class 8	224
Covered slide for marine evacuation - IMO305	203
Customised Signs	196
Danger Index	70
Davit-launched liferaft - E039	43
Deluge system - IMO127	209
Device for applying foam - IMO116	208
Device for launching buoyant line - IMO319	204
Device for shutting off entry or exit of the external ventilation - IMO172	212
Direction arrow 135°, down right corner - A135	21
Direction arrow 45°, top right corner - A045	19
Direction arrow 45°, top right corner - A045R	66
Direction arrow 90°, to the right - A090	20
Direction arrow 90°, to the right - A090R	66
Direction arrow - PIC 455	226
Direction arrow 270°, to the left - A270	21
Disabled access - PIC 453	226
Disconnect before carrying out maintenance or repair - M021	175
Disconnect mains plug from electrical outlet - M006	160
Distress signal on survival craft - IMO317	204
Do not alter the state of the switch - P031	140
Do not extinguish with water - P011	120
Do not leave the tow-track - P037	144

Description	Page
Do not obstruct - P023	132
Do not ram into toboggan - P047	151
Do not set off fireworks - P040	145
Do not spray with water - P016	125
DO NOT STACK - STE 16	230
Do not stretch out of toboggan - P046	150
Do not swing the chair - P038	144
Do not tie knots in rope - P030	139
Do not touch - P010	119
Do not use for face grinding - P032	141
Do not use for wet grinding - P033	141
Do not use lift in the event of fire - P020	129
Do not use this device in a bathtub, shower or ... - P026	135
Do not use this incomplete scaffold - P025	134
Do not use this lift for people - P027	136
Do not use with hand-held grinding machine - P034	142
Do not walk or stand here - P024	133
Do not wear gloves - P028	137
Do not wear metal-studded footwear - P035	143
Doctor - E009	26
Door opens by pulling on the left-hand side - E057	48
Door opens by pulling on the right-hand side - E058	48
Door opens by pushing on the left-hand side - E022	38
Door opens by pushing on the right-hand side - E023	38
Door slides left to open - E034	42
Door slides right to open - E033	42
Double-sided adhesive foam	233
Drinking water - E015	32
Drinking water - IMO341	206
Drinking water - PIC 452	226
Electronic cigarettes allowed - PIC 901	195
Electronic cigarettes permitted - PIC 901	227
Embarkation ladder - E053	47
Emergency control panel - IMO177	213
Emergency escape breathing device - E029	41
Emergency exit (left) - A0/E001	12
Emergency exit (left) - A180/E001	12
Emergency exit (left) - A225/E001	13
Emergency exit (left) - A270/E001	13
Emergency exit (left) - A315/E001	14
Emergency exit (left) - E001	11
Emergency Exit (left) - IMO326	205
Emergency exit (right) - E002	15
Emergency exit (right) - E002/A0	16

Description	Page
Emergency exit (right) - E002/A135	18
Emergency exit (right) - E002/A180	18
Emergency exit (right) - E002/A45	17
Emergency exit (right) - E002/A90	17
Emergency Exit (right) - IMO325	205
Emergency fire-pump - IMO119	208
Emergency generator - IMO176	213
Emergency hammer - E025	39
Emergency phone - IMO329	205
Emergency phone in the Event of fire - IMO404	214
Emergency phone station - IMO125	209
Emergency position indicating radio beacon - E052	46
Emergency shower - IMO330	205
Emergency stop button - E020	37
Emergency stop button - IMO328	205
Emergency telephone - E004	23
Emergency window - E016C	34
Emergency window with escape ladder (left) - E016	33
Emergency window with escape ladder (right) - E016B	34
Entrance - PIC 456	226
Escape ladder - E059	49
Evacuation & First Aid	10
Evacuation & First Aid - Maritime Signage	203
Evacuation assembly point - A270/E007	24
Evacuation assembly point - E007	24
Evacuation chair - E060	49
Evacuation temporary refuge - E024	39
Ex Logo - PIC 1521	229
Existing plant with fire valves - IMO157	211
Exit - IMO351	206
Extinguisher - IMO401	214
Extinguisher code signs	67
Eye wash - IMO327	205
Eyewash station - E011	28
Fire alarm button/switch - IMO102	207
Fire alarm call point - F005	57
Fire alarm horn - IMO103	207
Fire alarm panel - IMO143	210
Fire alarm post - IMO104	207
Fire alarm post - IMO402	214
Fire axe - IMO126	209
Fire blanket - F016	65
Fire cabinet with sprinkler/fire hose - IMO158	211
Fire damper in the ventilation line - IMO163	212

Index by description

Description	Page
Fire detector - IMO155	211
Fire emergency telephone - F006	59
Fire extinguisher - F001	53
Fire extinguisher/Fire alarm call point - F001/F005	58
Fire extinguisher/Fire alarm call point/Fire hose reel - F001/F002/F005	58
Fire extinguisher/Fire hose reel - F001/F002	58
Fire hall - IMO130	209
Fire hose reel - F002	54
Fire hose reel - IMO403	214
Fire ladder - F003	55
Fire monitor - F015	64
Fire protection door - F007	60
Fire protection plan - IMO101	207
Fire pump - IMO160	211
Fire Safety - Maritime Signage	207
Fire Safety Index	52
Fire-fighting equipment - IMO405	214
First aid - E003	22
First aid - IMO324	204
Fixed fire extinguisher bottle - F013	63
Fixed fire extinguisher installation - F012	63
Fixed fire extinguishing battery - F008	61
Flammable liquids - ADR 3a - Class 3	223
Flammable liquids - ADR 3b - Class 3	223
Flammable solid substances - ADR 4.1 - Class 4	223
Flammable solid substances - ADR 4.2 - Class 4	223
Flammable solid substances - ADR 4.3 - Class 4	223
Flammable solid substances - ADR 4.3b - Class 4	223
Foam circuit valve - IMO117	208
Foam gun - IMO114	208
Foam hose - IMO115	208
Fragile - PIC 12	230
Fragile - STE 14	230
Fragile keep dry - STE 15	230
Free harnessesFollowing the launching order - IMO207	216
Free up the lifeboat slipwaysFollowing the launching order - IMO210	216
Gas detector - IMO162	212
General mandatory sign - M001	155
General prohibition sign - P001	111
Go for zero	6
Halon trigger station - IMO149	211
HalonHorn - IMO112	207
Handle with care - STE 13	230
Hazardous Substances Signage	217

Description	Page
Heat detector - IMO161	212
High-expansion capacity foam supply tank - IMO174	213
IMDG Maritime Transport Sign - Class 9	224
IMDG Maritime Transport Sign - High temperature	224
Immediately leave the tow-track in the event of falling - M035	185
Inert gas extinguisher system - IMO173	212
Infant's lifejacket - E046	45
Infants must be protected with opaque eye protection - M025	179
International coupling - IMO159	211
Keep distances - M052	192
Keep dry - PIC 10	229
Keep locked - M028	181
Keep upright - PIC 011	230
Levels (-2 to +9) - PIC 373	50
Life jacket - IMO311	203
Life jacket for children - IMO312	203
Life raft - IMO302	203
Life raft - IMO303	203
Life raft for deployment by davit - IMO304	203
Lifeboat - E036	42
Lifeboat - IMO301	203
Lifebuoy - E040	43
Lifebuoy with light - E042	44
Lifebuoy with line - E041	44
Lifebuoy with line and light - E043	44
Lifejacket - E044	44
Lifeline - IMO307	203
Lifeline with floating Line - IMO308	203
Lifeline with Lighting and smoke device - IMO310	203
Lifeline with Lighting device - IMO309	203
Liferaft - E038	43
Liferaft knife - E035	42
Lift - PIC 463	227
Lift ski tips - M036	185
Line-throwing appliance - E050	46
Lithium Battery Mark - ADR-LBM	230
Lithium Battery Mark - Customisable - ADR-LBM	230
Lower Lifeboat into the water following the Launch... - IMO204	216
Lower lifeboat to the water in launch sequence - M039	187
Lower liferaft to the water in launch sequence - M040	187
Lower rescue boat to the water in launch sequence - M041	187
Lower the Life raft into the water following the Launching... - IMO205	216
Lower the Liferaft into the water following the Launching... - IMO206	216
Magnetic strips	233

Description	Page	Description	Page
Main route of evacuation - IMO170	212	Non-flammable, flammable gases - ADR 2.1a - Class 2	223
Main vertical area - IMO142	210	Non-flammable, flammable gases - ADR 2.1b - Class 2	223
Mandatory - Maritime Signage	216	Non-flammable, flammable gases - ADR 2.1b - Class 2	223
Mandatory Index	154	Non-flammable, flammable gases - ADR 2.2b - Class 2	223
Manual activation station - IMO105	207	Non-flammable, flammable gases - ADR 2.3 - Class 2	223
Marine evacuation chute - E055	47	Not drinking water - P005	115
Marine evacuation slide - E054	47	Not for people in the state of intoxication - P043	148
Marine evacuation slide - IMO306	203	Not for pregnant women - P042	147
Maritime Signage	201	Number 0 - IMO331	205
Materials for signs	4	Number 0 - IMO421	214
Medical grab bag - E027	40	Number 1 - IMO332	205
Men's WC - PIC 466	227	Number 1 - IMO422	214
Miscellaneous hazardous substances - ADR 9 - Class 9	224	Number 2 - IMO333	205
Miscellaneous hazardous substances - ADR EHS - Class 9	224	Number 2 - IMO423	214
Mousse extinguisher system - IMO113	208	Number 3 - IMO334	205
Mousse trigger post - IMO118	208	Number 3 - IMO424	214
NiteGlo™ and Xtra Glo™ glow-in-the-dark signs	202	Number 4 - IMO335	205
No access for fork lift trucks and other industrial vehicles - P006	116	Number 4 - IMO425	215
No access for people with active implanted cardiac devices - P007	117	Number 5 - IMO336	205
No access for persons with metallic implants - P014	123	Number 5 - IMO426	215
No access for unauthorised persons - PIC 209 (=PIC 2110)	152	Number 6 - IMO337	206
No access for unauthorized persons - PIC 209	152	Number 6 - IMO427	215
No activated mobile phones - P013	122	Number 7 - IMO338	206
No children allowed - P036	143	Number 7 - IMO428	215
No climbing - P009	119	Number 8 - IMO339	206
No dogs - P021	130	Number 8 - IMO429	215
No eating or drinking - P022	131	Number 9 - IMO340	206
No entry - PIC 229	153	Number 9 - IMO430	215
No heavy load - P012	121	Occupational Safety Signs Index	7
No leaning against - P041	146	Opaque eye protection must be worn - M007	161
No metallic articles or watches - P008	118	Open safety bar of chairlift - M034	184
No open flame; Fire, open ignition source and smoking... - P003	113	Open/Close assembly system	233
No parking - PIC 225	153	Other Signage and Accessories	225
No photography - P029	138	Oxydizing substances and organic peroxides - ADR 5.1 - Class 5	224
No pushing - P017	126	Oxydizing substances and organic peroxides - ADR 5.2 - Class 5	224
No reaching in - P015	124	Oxydizing substances and organic peroxides - ADR 5.2 - Class 5	224
No sitting - P018	127	Oxygen resuscitator - E028	40
No smoking - P002	112	P50 wheel-mounted extinguisher - IMO185	213
No smoking including electronic cigarettes - P002/PIC 900	112	Packaging labels	229
No smoking of electronic cigarettes - PIC 900	152	Parachute flare bomb - IMO318	204
No stepping on surface - P019	128	Parking - PIC 454	226
No Stopping (Clearway) - PIC 226	153	Phone - PIC 458	226
No thoroughfare - P004	114	Phone - PIC 459	226
No waiting - PIC 227	156	Photoluminescent Area Marking	69

Index by description

Description	Page	Description	Page
PIC 292 – Disabled access - PIC 292	226	Sound horn - M029	182
PIC 293 – Information - PIC 293	226	Space protected by automatic fire alarm - IMO106	207
Portable device for applying foam - IMO136	209	Space protected by CO2 - IMO107	207
Portable extinguisher with halon 1211/4 - IMO181	213	Space protected by delugeSystem - IMO128	209
Portable foam applicator unit - F010	62	Sprinkler block valves - IMO147	210
Portable LW9 extinguisher - IMO180	213	Sprinkler horn - IMO146	210
Portable VHF radio - IMO314	204	Sprinkler System - IMO144	210
PortableP1 extinguisher - IMO184	213	Stairs - IMO343	206
PortableP2 extinguisher - IMO183	213	Stairs - PIC 461	226
PortableP6 extinguisher - IMO179	213	Standby bilge pump - IMO122	208
Poster Safety Signs	8	Start air Supply following the launching order - IMO209	216
Powder cannon - IMO152	211	Start air supply in launch sequence - M044	188
Powder extinguisher system - IMO151	211	Start engine in launch sequence - M038	186
Powder hose and lance - IMO153	211	Start the motor in the launching order - IMO203	216
Powder trigger station - IMO154	211	Start water spray in launch sequence - M043	188
Prohibited for all types of vehicles - PIC 228	153	Start water Sprinkler following the launching order - IMO208	216
Prohibition Index	110	Stretcher - E013	30
Protection shelter - E021	37	Super Heavy - PIC 490	224
Public information	226	Survival clothing - E056	47
Radio beacon for locating accidents - IMO315	204	Survival craft distress signal - E048	45
Refer to instruction manual/booklet - M002	156	SurvivalSuit - IMO313	204
Release falls in launch sequence - M042	187	Symbol labels	228
Release lifeboat gripes in launch sequence - M045	188	Tank of CO2/nitrogen - IMO175	213
Remote controlled fire pumps - IMO120	208	Temperature indicating labels	231
Remote release station - F014	64	Thermal protection cover - IMO344	206
Remote switch for ventilation - IMO178	213	Thermal protection suit - IMO345	206
Remote-controlled fuel/lubricating oil valves - IMO165	212	Toxic and harmful substances - ADR 6.1 - Class 6	224
Remote-controlled skylights - IMO164	212	Toxic and harmful substances - ADR 6.2 - Class 6	224
Rescue boat - E037	43	Traffic Signs	153
Rescue window - E017	34	Transport Signage	223
Rocket parachute flare - E049	46	Turn anticlockwise to open - E018	35
Safety shower - E012	29	Turn clockwise to open - E019	36
Safety Sign Sliders	198	Two-way VHF radiotelephone apparatus - E051	46
Search and rescue transponder - E047	45	Use barrier cream - M022	176
Search and rescue transponder - IMO316	204	Use footbridge - M023	177
Secondary evacuation route - IMO171	212	Use gas detector - M048	190
Secure gas cylinders - M046	189	Use handrail - M012	166
Shipboard assembly station - E032	41	Use handrail - PIC 468	227
Shipboard general alarm - E031	41	Use handrail - PIC 469	227
Sign and label printers	235	Use handrail - PIC 470	227
Smoke detector - IMO156	211	Use litter bin - M030	182
Smoking allowed - PIC 2600	195	Use of smart glasses prohibited - P044	149
Smoking area - IMO352	206	Use protective apron - M026	180

Description	Page
Use self-contained breathing appliance - M047	189
Use table saw adjustable guard - M031	183
Use this walkway - M024	178
Voltage Markers	83
Warning; Arc flash - W042	107
Warning; Asphyxiating atmosphere - W041	106
Warning; Automatic start-up - W018	89
Warning; Barbed wire - W033	102
Warning; Battery charging - W026	97
Warning; Biological hazard - W009	79
Warning; Bull - W034	103
Warning; Corrosive substance - W023	94
Warning; Counter rotating rollers - W025	96
Warning; Crushing - W019	90
Warning; Crushing of hands - W024	95
Warning; Drop (fall) - W008	78
Warning; Earth - PIC 329	109
Warning; Electricity - W012	82
Warning; Electrostatic - PIC 327	109
Warning; Explosive atmosphere - PIC 2516 (PIC 313)	108
Warning; Explosive material - W002	72
Warning; Falling ice - W039	105
Warning; Falling objects - W035	103
Warning; Floor level obstacle - W007	77
Warning; Fork lift trucks and other industrial vehicles - W014	85
Warning; Fragile roof - W036	104
Warning; General sign - W001	71
Warning; Guard dog - W013	84
Warning; Hand crushing between press brake tool - W030	101
Warning; Hand crushing between press brake tool - W031	101
Warning; Hot surface - W017	88
Warning; laser beam - W004	74
Warning; Low temperature/freezing conditions - W010	80
Warning; Magnetic field - W006	76
Warning; Non-ionizing radiation - W005	75
Warning; Optical radiation - W027	98
Warning; Overhead load - W015	86
Warning; Overhead obstacles - W020	91
Warning; Oxidizing substance - W028	99
Warning; Pressurised cylinder - W029	100
Warning; Radioactive material or ionizing radiation - W003	73
Warning; Rapid movement of workpiece in press brake - W032	102
Warning; Risk of fire/Flammable materials - W021	92

Description	Page
Warning; Roof avalance - W040	106
Warning; Run over by remote operator controlled machine - W037	104
Warning; Sharp elements - W022	93
Warning; Slippery surface - W011	81
Warning; Sudden loud noise - W038	105
Warning; Toxic Irritant Health hazard - PIC 321	108
Warning; Toxic material - W016	87
Wash your hands - M011	165
Water cannon - IM0123	208
Water fog applicator - F011	62
Water spray fire-extinguisher system - IM0124	208
Wear a mask - M016	170
Wear anti-static footwear - M032	183
Wear ear protection - M003	157
Wear eye protection - M004	158
Wear face shield - M013	167
Wear head protection - M014	168
Wear high visibility clothing - M015	169
Wear lab coats - PIC 2209	194
Wear life jacket - PIC 281	194
Wear protective clothing - M010	164
Wear protective footwear - PIC 280	192
Wear protective gloves - M009	163
Wear protective headgear - PIC 269	193
Wear protective headgear - PIC 283	193
Wear protective headgear - PIC 286	193
Wear protective roll sport equipment - M049	190
Wear respiratory protection - M017	171
Wear safety belts - M020	174
Wear safety footwear - M008	162
Wear safety harness - M018	172
Wear welding mask - M019	173
WEEE and RoHS compliant labels	228
Wheelchair access - PIC 1216	194
Wheeled fire extinguisher - F009	61
Women's WC - PIC 465	227

Africa

Randburg, South Africa
 Tel.: +27 11 704 3295
 Email: africa@bradycorp.com

Benelux

Zele, Belgium
 Tel.: +32 (0) 52 45 78 11
 Email: benelux@bradycorp.com

Central & Eastern Europe

Bratislava, Slovakia
 Tel.: +421 2 3300 4800
 Email: central_europe@bradycorp.com

Denmark

Odense
 Tel.: +45 66 14 44 00
 Email: denmark@bradycorp.com

France

Roncq
 Tel.: +33 (0) 3 20 76 94 48
 Email: france@bradycorp.com

Germany, Austria & Switzerland

Egelsbach, Germany
 Tel.: +49 (0) 6103 7598 660
 Email: germany@bradycorp.com

Hungary

Budaörs
 Tel.: +36 23 500 275
 Email: central_europe@bradycorp.com

Italy

Gorgonzola
 Tel.: +39 02 26 00 00 22
 Email: italy@bradycorp.com

Middle East FZE

Dubai, UAE
 Tel.: +971 4881 2524
 Email: me@bradycorp.com

Norway

Kjeller
 Tel.: +47 70 13 40 00
 Email: norway@bradycorp.com

Romania

Bucharest
 Tel.: +40 21 202 3032
 Email: central_europe@bradycorp.com

Russia

Moscow
 Tel.: +7 495 269 47 87
 Email: central_europe@bradycorp.com

Spain & Portugal

Madrid, Spain
 Tel.: +34 900 902 993
 Email: spain@bradycorp.com,
 portugal@bradycorp.com

Sweden, Finland, Baltic states

Kista, Sweden
 Tel.: +46 (0) 8 590 057 30
 Email: sweden@bradyeurope.com

Turkey

Istanbul
 Tel.: +90 212 264 02 20 / 264 02 21
 Email: turkey@bradycorp.com

UK & Ireland

Banbury, UK
 Tel.: +44 (0) 1295 228 288
 Email: uk@bradycorp.com

Our mission is to identify and protect people, products and places



To help minimise our impact on the environment, Brady limits its number of reprints.

Updated versions are always available for download on www.bradyeurope.com.



Search for: EUR-M-796-EN



Y4232310

Your distributor

